

**Planning & Zoning Commission**  
Bastrop City Hall City Council Chambers  
1311 Chestnut Street  
Bastrop, TX 78602  
(512) 332-8840



---

## Agenda – June 28, 2018 at 6:00 P.M.

---

*City of Bastrop Planning and Zoning Commission meetings are available to all persons regardless of disability. If you require special assistance, please contact the Commission Secretary at (512) 332-8800 or write 1311 Chestnut Street, 78602, or by calling through a T.D.D. (Telecommunication Device for the Deaf) to Relay Texas at 1-800-735-2989 at least 48 hours in advance of the meeting.*

---

**1. CALL TO ORDER**

**2. CITIZEN COMMENTS**

*Comments will be heard from the audience on any topic not listed on the agenda, not to exceed three (3) minutes in length. To address the Commission, please submit a fully completed request card to the Commission Secretary prior to the beginning of the meeting. In accordance with the Texas Open Meetings Act, if a citizen discusses any item not on the agenda, the Commission cannot discuss issues raised or make any decision at this time. Issues may be referred to City Staff for research and possible future action.*

*To address the Commission concerning any item on the agenda, please submit a fully completed request card to the Commission Secretary prior to the consideration of that item.*

**3. ITEMS FOR INDIVIDUAL CONSIDERATION**

- 3A. Consider action to approve meeting minutes from the May 31, 2018 Planning & Zoning Commission Regular Meeting.
- 3B. Public hearing and consider action to approve the ordinance for an amendment to the Signs Ordinance, Article 3.20 of the City of Bastrop Code of Ordinances, to allow digital signs on pole or pylon signs and including size and placement restrictions and forward to the next City Council meeting.
- 3C. Consider action to recommend approval of the Pecan Park, Section 1A Preliminary Plat, being 13.994 acres out of the Mozea Rousseau Survey, Abstract 56, located east of the future extension of Sterling Drive, within the city limits of Bastrop, Texas and forward to the next City Council meeting.

- 3D. Consider action to recommend approval of the Pecan Park, Section 3B, 3C, 3D, & 3E Preliminary Plat, being 28.675 acres out of the Mozea Rousseau Survey, Abstract 56, located north of the extension of Childers Drive, within the city limits of Bastrop, Texas and forward to the next City Council meeting.

**4. WORKSHOP SESSION**

- 4A. Discussion with the future developers for the northeast corner of SH 95 and Chestnut Street for the rezoning of the exiting Commercial Mixed Use and Commercial-2 zoning into one commercial district.
- 4B. Update and discussion on the Draft Subdivision Ordinance.

**5. UPDATES**

- 5A. Individual Requests from Planning and Zoning Commissioners that particular items to be listed on future agendas (no group discussion allowed).

**6. ADJOURNMENT**

I, the undersigned authority, do hereby certify that this Notice of Meeting as posted in accordance with the regulations of the Texas Open Meetings Act on the bulletin board located at the entrance to the City of Bastrop City Hall, a place of convenient and readily accessible to the general public, as well as to the City's website, [www.cityofbastrop.org](http://www.cityofbastrop.org) and said Notice was posted on the following date and time: Friday, June 22, 2018 at 8:00 a.m. and remained posted for at least two hours after said meeting was convened.

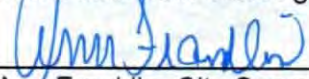
  
\_\_\_\_\_  
Ann Franklin, City Secretary

# Planning and Zoning Commission Meeting Minutes

The City of Bastrop Planning and Zoning Commission met Thursday, May 31, 2018 at 6:00 p.m. in the Bastrop City Council Chambers, 1311 Chestnut Street, Bastrop, Texas.

## 1. CALL TO ORDER

Debbie Moore called the meeting to order at 6:00 p.m.

Debbie Moore	Present
Patrick Connell	Present
Dianna Rose	Present
Cynthia Meyer	Present
Matthew Lassen	Present
Sue Ann Fruge	Absent
Richard Gartman	Present
Cheryl Lee	Present

## 2. CITIZEN COMMENTS

There were no citizen comments.

## 3. ITEMS FOR INDIVIDUAL CONSIDERATION

### **3A. Consider action to approve meeting minutes from the April 26, 2018 Planning & Zoning Commission Regular Meeting.**

Patrick Connell made a motion to approve the meeting minutes from the April 26, 2018 Planning & Zoning Commission Regular Meeting. Richard Gartman seconded the motion and the motion carried unanimously.

### **3B. Consider action to recommend approval of The Colony MUD 1A, Section 3, Phase A and B Preliminary Plat being 100.289 acres out of the Jose Manuel Bangs Survey, Abstract 5, located east of FM 969 within the Statutory Extra-Territorial Jurisdiction of Bastrop, Texas and forward to City Council for consideration at their next meeting.**

Jennifer Bills presented to the Commission the information that was given in the staff report and gave a PowerPoint presentation.

The Commission made the following comments on the Colony MUD 1A, Section 3, Phase A and B Preliminary Plat:

How is drainage being conveyed?

The drainage for this section is being conveyed through the street infrastructure directly to the Colorado River without any detention.

# Planning and Zoning Commission Meeting Minutes

When are the additional acceleration/deceleration lanes going to be provided?

They are under construction now with the improvements for The Colony MUD 1A, Section 1.

Patrick Connell made a motion to recommend approval of The Colony MUD 1A, Section 3, Phase A and B Preliminary Plat being 100.289 acres out of the Jose Manuel Bangs Survey, Abstract 5, located east of FM 969 within the Statutory Extra-Territorial Jurisdiction of Bastrop, Texas and be forwarded to City Council for consideration at their next meeting. Diana Rose seconded the motion and the motion carried unanimously.

**3C. Public hearing and consider action to recommend approval of a Conditional Use Permit to allow a brewery, distillery and winery use on 0.046 acres of Building Block 3 West of Water Street (809 Main Street), an area zoned HMS, Historic Main Street, and (0.184 acres of Building Block 3 West of Water Street (705 Pine Street), an area zoned DMU, Downtown Mixed Use, within the city limits of Bastrop and forward to City Council for consideration at their next meeting.**

Jennifer Bills presented to the Commission the information that was given in the staff report and gave a PowerPoint presentation.

Discussion commenced between Staff and the Planning and Zoning Commission regarding the Copper Shot Distillery and the proposed location.

Patrick Connell made a motion to recommend approval of a Conditional Use Permit to allow a brewery, distillery and winery use on 0.046 acres of Building Block 3 West of Water Street (809 Main Street), an area zoned HMS, Historic Main Street, and (0.184 acres of Building Block 3 West of Water Street (705 Pine Street), an area zoned DMU, Downtown Mixed Use, within the city limits of Bastrop and be forwarded to City Council for consideration at their next meeting. Cynthia Meyer seconded the motion and the motion carried unanimously.

**3D. Public Hearing and consider action to recommend approval of a rezone for the northeast corner of SH 95 and Chestnut Street to C-1, Commercial 1, consisting of Lots 1 & 2 of the Lee-Jackson & Fowler Subdivision (1.717 acres) currently Form-based Code Character Zone CMU, Commercial Mixed Use, and 0.398 acres of Bastrop Town Tract Abstract 11 and 2.046 acres of Building Block 12 East of Water Street currently C-2, Commercial 2, within the city limits of Bastrop, and forward to City Council for consideration at their next meeting.**

Jennifer Bills presented to the Commission the information that was given in the staff report and gave a PowerPoint presentation.

The Commission made the following comments on the proposed rezone for the northeast corner of SH 95 and Chestnut Street to C-1, Commercial 1:

- The Commission did not want to remove the northeast corner of SH 95 and Chestnut from the Form-based Code area by removing the Commercial Mixed Use zoning.

# Planning and Zoning Commission

## Meeting Minutes

- The Commission did not feel that a convenience store/fuel station use was appropriate for a gateway intersection to the city.
- Members of the public stated concerns about the existing traffic and future traffic generated by a fuel station.

Patrick Connell made a motion to recommend denial of a Conditional Use Permit to of a rezone for the northeast corner of SH 95 and Chestnut Street to C-1, Commercial 1, consisting of Lots 1 & 2 of the Lee-Jackson & Fowler Subdivision (1.717 acres) currently Form-based Code Character Zone CMU, Commercial Mixed Use, and 0.398 acres of Bastrop Town Tract Abstract 11 and 2.046 acres of Building Block 12 East of Water Street currently C-2, Commercial 2, within the city limits of Bastrop, and be forwarded to City Council for consideration at their next meeting. Cynthia Meyer seconded the motion and the motion carried with a vote of 5-2.

### **3E. Public Hearing and consider action to recommend approval of a subdivision variance to waive the requirement of Section 5.20 – Streets, to improve or post fiscal surety for the construction of 50 percent of C.P. Johnson Lane, between Farm Street and Fairview Cemetery and forward to City Council for consideration at their next meeting.**

Jennifer Bills presented to the Commission the information that was given in the staff report and gave a PowerPoint presentation.

The Commission made the following comments on the proposed subdivision variance to waive the requirement of Section 5.20 – Streets, to improve or post fiscal surety for the construction of 50 percent of C.P. Johnson Lane:

The Commission questioned if this process would still be necessary under the new subdivision ordinance. Staff clarified that it would, but the final decision would go to Planning & Zoning instead of City Council.

Patrick Connell made a motion to recommend approval of a subdivision variance to waive the requirement of Section 5.20 – Streets, to improve or post fiscal surety for the construction of 50 percent of C.P. Johnson Lane, between Farm Street and Fairview Cemetery and be forwarded to City Council for consideration at their next meeting. Matthew Lassen seconded the motion and the motion carried unanimously.

## **4. UPDATES**

### **4A. Update on the Draft Subdivision Ordinance.**

Jennifer Bills informed the Commission Staff was going to tweak the Lot of Record requirement as suggested by the Commission and was working on determining a new threshold that would trigger platting requirements.

She also informed to the Commission of the upcoming public hearing for the proposed subdivision ordinance.

# Planning and Zoning Commission Meeting Minutes

## **4B. Update on the Draft Mobile Food Vendor Ordinance**

Jennifer Bills stated Staff was still working on developing standards and language for the proposed Mobile Food Vendors Ordinance and was hoping to have a draft ready by July.

## **5. ADJOURNMENT**

Patrick Connell made a motion to adjourn at 7:16 pm. Mathew Lassen seconded the motion, and the motion carried unanimously.

---

Debbie Moore, Chair

---

Patrick Connell, Vice Chair

# PLANNING & ZONING STAFF REPORT



**MEETING DATE:** June 28, 2018

**Item:** 3B

**TITLE:**

Public hearing and consider action to approve the ordinance for an amendment to the Signs Ordinance, Article 3.20 of the City of Bastrop Code of Ordinances, to allow digital signs on pole or pylon signs and including size and placement restrictions and forward to the next City Council meeting.

**STAFF REPRESENTATIVE:**

Jennifer C. Bills, AICP, LEED AP, Assistant Planning Director

**BACKGROUND/HISTORY:**

The Bastrop Code of Ordinances, Section 3.20 – Signs contains the regulations regarding the types, size, and locations of signage within the city limits and along specific highways within the Statutory Extraterritorial Jurisdiction. This section was re-written in 2006 and amended in 2011 to allow electronic messaging on certain signage.

Recent requests have been made to allow legal, non-conforming signage to be able to upgrade existing sign faces to incorporate a limited amount of electronic messaging area. Additionally, past sign code interpretation has resulted in pylon/pole sign types to incorporate electronic signage. Due to these factors, City Council requested that staff propose amendments to the code that would address these issues.

A legal, non-conforming sign is a sign which was legally installed prior to the adoption of the current code. These include signs installed prior to the 2006 updates, or signs that were installed prior to annexation of the property into the city limits. Non-conforming signs can change the sign face, but cannot make any changes that would increase the degree of non-conformity.

Currently, Section 3.20.015 (5) *Electronic message (L.E.D.)* is allowed in two sign types at a specific percentage of the total sign area:

- (A) Such signs shall be allowed in the following circumstances:
  - (i) When incorporated into a permitted monument sign; or
  - (ii) When used to display fuel prices on a permitted fuel pricing sign.
- (B) Such signs shall not exceed 25% of the area of the sign.

This section also includes limits on the motion of the picture and how often the sign can change message:

- (C) Any change of pictures or information on the sign shall not produce the illusion of scrolling, moving objects, expanding or contracting shapes, rotation or any similar effect of animation.
- (D) Any change of pictures or information on the sign shall not change more often than once every eight (8) seconds except for message display of time or temperature. Each change of pictures or information must constitute a complete

phrase or thought and not be the completion of a previous phrase or thought. Each change of pictures or information must be completed in two (2) seconds or less and may not include visually distracting techniques such as flashing, racing, strobing, twinkling, animation, etc.

Staff is proposing amendments that would allow up to 25% of the sign face of new pylon/pole signs include electronic signage. The maximum permitted sign face for a pylon sign in the current code is 160 square feet, so the electronic messaging can comprise a maximum of 40 square feet of the total sign face.

For legal, non-conforming signs that are already over 160 square feet, the owner would be allowed to convert up to 40 square feet of the existing sign face to electronic.

For legal, non-conforming signs that are under 160 square feet, the owner would be able to convert up to 30% of the existing sign face to electronic, up to a maximum of 40 square feet. .

The proposed amendment would allow the electronic portion of the sign to be incorporated into one sign face, or be a separate sign face on the same pole, as long as the total of all sign faces is limited to 160 square feet (or the previous total non-conforming sign area for signs over 160 square feet). Additionally the electronic messaging portion of a separate sign must be located below the static sign face area.

The proposed amendment would be added to Section 3.20.015 (5) (amended language in red):

## **Chapter 3 – BUILDING REGULATIONS**

### **ARTICLE 3.20 – SIGNS**

#### Sec. 3.20.015 - Standards for permanent signs

\* \* \*

#### (5) Electronic message (L.E.D.).

(A) Such signs shall be allowed in the following circumstances:

- (i) When incorporated into a permitted monument sign; or
- (ii) When used to display fuel prices on a permitted fuel pricing sign; or
- (iii) When placed on a new or existing permitted on-premises pole or pylon sign; or
- (iv) When placed on a legal, nonconforming on-premises pole or pylon sign.

(B) Signs permitted under Sections (5)(A)(i) or 5(A)(ii) shall not exceed 25% of the area of the sign.

(C) Signs permitted under Sections (5)(A)(iii) or 5(A)(iv):

- (i) if placed on a new or existing pole or pylon sign, the digital sign face shall only be a part of the total sign face and shall not exceed 25% of the total sign face or may be a separate digital sign face whose size shall not exceed 25% of the total sign face area when both digital and non-digital sign face areas are combined;
- (ii) legal, non-conforming pole or pylon signs 160 square feet or greater, may convert up to forty (40) square feet of the current sign face to a digital sign face, or may install a separate digital sign face whose size shall not exceed forty (40) square feet and whose addition does not increase the total sign face area when sign face areas of both the digital and non-digital sign are combined;
- (iii) legal, non-conforming pole or pylon signs of less than 160 square feet may convert up to 30% of the current sign face or 40 square feet, whichever is less, to a digital sign or may add a digital sign that is up to 30% of the combined sign face areas, or 40 square



feet, whichever is less, such that the entire sign face area, when digital and non-digital sign face areas are combined, does not exceed 160 square feet;

- (D) Any change of pictures or information on the sign shall not produce the illusion of scrolling, moving objects, expanding or contracting shapes, rotation, or any similar effect of animation.
- (E) Any change of pictures or information on the sign shall not change more often than once every eight (8) seconds except for message display of time or temperature. Each change of pictures or information must constitute a complete phrase or thought and not be the completion of a previous phrase or thought. Each change of pictures or information must be completed in two (2) seconds or less and may not include visually distracting techniques such as flashing, racing, strobing, twinkling, animation, etc.
- (F) Only one sign face per pylon or pole sign may contain a digital sign face and any separate digital sign shall be located below the non-digital sign.

The section defining Non-conforming signs would also need to be amended to reflect the ability to change of portion of the existing sign to include electronic messaging.

#### Sec. 3.20.019 - Nonconforming signs.

(a) A nonconforming sign is a sign which was installed legally prior to the adoption of this article or amendments of this article, but does not comply with the current sign regulations. A nonconforming sign shall be allowed to be continued and maintained at its existing location subject to the following conditions: The face of the sign may be changed, but no change or alteration shall be made that would increase the degree of nonconformity. **A change to the sign face or the addition of a digital sign as allowed by Section 3.20.015 shall not affect the legal, nonconforming status of the sign.**

(b) An on-premises sign, conforming or otherwise, may be removed no sooner than the first anniversary of the date the business, person, or activity that the sign or sign structure identifies or advertises ceases to operate on the premises on which the sign or sign structure is located. If the premises containing the nonconforming sign or sign structure are leased, the sign must be removed no later than the second anniversary after the date the most recent tenant ceases to operate on the premises. The director's decision may be appealed to the planning and zoning commission.

(c) A nonconforming sign may not be reconstructed, repaired, or replaced for any purpose other than maintenance operations or for changing the letters, symbols, or other matter on the sign. Reconstruction, repair, or replacement of a nonconforming sign shall be completed no later than ninety (90) days following the date of the damage. For purposes of this subsection, a sign, or a substantial part of a sign, is considered destroyed if it is blown down, dismantled or the cost of repairing the sign is more than 60% of the cost of erecting a new sign of the same type at the same location. **A change to the sign face or the addition of a digital sign as allowed by Section 3.20.015 shall not affect the legal, nonconforming status of the sign or be considered reconstruction, repair, or replacement of the sign as defined in this section.**

(d) If the city requires the relocation, reconstruction or removal of a sign, conforming or otherwise, within its corporate limits or its extraterritorial jurisdiction, the mayor shall appoint a municipal board of sign control pursuant to chapter 216 of the Local Government Code to determine the amount of compensation, if any, the owner of the sign is entitled to relocate, reconstruct or remove the sign. Prior to such determination, the owner of the sign shall be given the opportunity for a hearing before the municipal board about the issues involved.

**PUBLIC NOTIFICATION:**

Notice of the public hearing was posted in the Bastrop Advertiser on June 9, 2018, more than 15 days prior to the public hearing.

**POLICY EXPLANATION:**

**10.2 - AUTHORITY TO AMEND ORDINANCE:**

The City Council may from time to time, after receiving a final report thereon by the Planning and Zoning Commission and **after public hearings required by law, amend, supplement, or change the regulations herein provided** or the boundaries of the zoning districts specified on the Zoning Map. Any Ordinance regulations or Zoning District boundary amendment may be ordered for consideration by the City Council, be initiated by the Planning and Zoning Commission, or be requested by the owner of real property, or the authorized representative of an owner of real property.'

*The Planning & Zoning Commission will hold public hearing and make a recommendation on the amendment to City Council. The City Council will hold a public hearing and two ordinance readings if this amendment is approved and adopted.*

**RECOMMENDATION:**

Hold public hearing and consider action to approve the ordinance for an amendment to the Signs Ordinance, Article 3.20 of the City of Bastrop Code of Ordinances, to allow digital signs on pole or pylon signs and including size and placement restrictions and forward to the next City Council meeting.

# PLANNING & ZONING STAFF REPORT



**MEETING DATE:** June 28, 2018

**Item:** 3C

**TITLE:**

Consider action to recommend approval of the Pecan Park, Section 1A Preliminary Plat, being 13.994 acres out of the Mozea Rousseau Survey, Abstract 56, located east of the future extension of Sterling Drive, within the city limits of Bastrop, Texas and forward to the next available City Council meeting.

**STAFF REPRESENTATIVE:**

Jennifer C. Bills, AICP, LEED AP, Assistant Planning Director

**ITEM DETAILS:**

Site Address:	East of the future extension of Sterling Drive (Attachment 1)
Total Acreage:	13.994 acres
Legal Description:	13.994 acres out of the Mozea Rousseau Survey, Abstract 56
Property Owner:	Ranch Road Development, LLC/Scott Miller
Agent Contact:	Carlson, Brigance, & Doering/Christine Methvin
Existing Use:	Vacant/Undeveloped
Existing Zoning:	Pecan Park Residential Planned Development
Planned Development District:	Patio Homes (PD PH)
Future Land Use:	Neighborhood Residential

**BACKGROUND/HISTORY:**

The applicant has submitted a new Preliminary Plat for the Pecan Park, Section 1A. The plat is creating 64 single-family detached lots, and two open space/drainage lots (Exhibit A). The single-family detached lots allowed under the Patio Homes district of the Planned Development and have a minimum width of 40 feet and a minimum of 4,600 square feet in size. 1,465 feet of streets will be dedicated for Driftwood Lane and Hamilton Pool Lane, which will be 50-foot wide residential ROWs. 391 feet of Sterling Drive, which will be a 60-foot wide collector will be dedicated with this section and will continue into the Pecan Park Commercial Subdivision to the north.

Traffic Impact and Streets

The Preliminary Plat proposes to extend Sterling Drive, a collector street, northward to provide the main access for Section 1A and will be the second primary access from Pecan Park back to Agnes Street/SH71. Secondary access will be provided by a connection to the future Trailside Drive, which is within the Preliminary Plat for Section 3B, 3C, 3D and 3E. The final plat for Section 1A cannot be recorded until the Final Plat for Pecan Park Commercial, Lot 8 is completed and recorded. Sidewalks will be installed along all proposed streets, and will connect to the proposed neighborhood trail system.

Utilities

Water service (domestic and fire) will be provided by the City via water line extensions from existing infrastructure located on Sterling Drive. These lines will be designed according to the

City's construction standards, as well as the Texas Commission on Environmental Quality's (TCEQ) requirements.

Wastewater collection and treatment will also be provided by the City, and will require the installation of lines that will ultimately connect to an existing wastewater lift station.

There is an existing LCRA substation and electrical easement to the north of the proposed subdivision. The applicant received a subdivision variance on November 12, 2014 to eliminate the requirement for 50 foot setback from high voltage transmission lines.

#### Drainage

The Preliminary Plat proposes to install an underground storm sewer system designed to drain runoff generated from the development into an existing system located adjacent to the future Section 2. The existing system was designed to accommodate this increase in peak flows, and ultimately connects to the Colorado River.

The proposed drainage system will be designed with a sufficient capacity to route flows from a 100-year design storm to the Colorado River. Due to the property's close proximity to the river, stormwater detention is not required.

#### **PUBLIC COMMENTS:**

Notifications to property owners within 200 feet were mailed on June 12, 2018. (Attachment 2)

#### **POLICY EXPLANATION:**

All Preliminary Plats must be reviewed by the Planning & Zoning Commission and are then forwarded to City Council for approval.

#### Compliance with 2036 Comprehensive Plan:

- Future Land Use Plan - Neighborhood Residential: The Neighborhood Residential character area is for single-family residential subdivision development, associated amenities such as parks, trails, open spaces and public uses such as schools, fire stations, and more.

*This preliminary plat complies with the Future Land Use Plan. The plat includes 64 single-family lots that will provide single-family detached units. There are also two open space lot that provide open space and drainage areas for this plat. This section is part of the Pecan Park development, in which the total development includes multiple phases that include parks, trails, and recreation facilities.*

- Objective 2.4.1: Invest in waste water system expansion in areas that promote infill and contiguous development.

*This development is within the City's wastewater service area and is vacant land immediately adjacent to existing development. This subdivision connects to existing wastewater lines and continues the system in an efficient manner*

- Goal 4.1.1 Provide a greater diversity of housing options in Bastrop while protecting the character of the City's existing neighborhoods.

*The Pecan Park Development includes six different residential lot standards. This plat utilizes the Patio Homes district, which allows 4,600 square foot lots with reduced rear and side setbacks to allow various single-family product types and with varied 20 and 25 foot front setbacks to provide visual appeal.*

#### Local Government Code

- Sec. 212.002. Rules.

After a public hearing on the matter, the governing body of a municipality may adopt rules governing plats and subdivisions of land within the municipality's jurisdiction to promote the health, safety, morals, or general welfare of the municipality and the safe, orderly, and healthful development of the municipality.

*Bastrop adopted subdivision regulations in 1981. The Code of Ordinances, Chapter 10 – Subdivisions outlines the requirements for plats within the Bastrop city limits and Extra Territorial Jurisdiction (ETJ).*

#### Section 212.004 Plat Required

- (a) The owner of a tract of land located within the limits or in the extraterritorial jurisdiction of a municipality who divides the tract in two or more parts to lay out a subdivision of the tract, including an addition to a municipality, to lay out suburban, building, or other lots, or to lay out streets, alleys, squares, parks, or other parts of the tract intended to be dedicated to public use or for the use of purchasers or owners of lots fronting on or adjacent to the streets, alleys, squares, parks, or other parts must have a plat of the subdivision prepared.

*The applicant has proposed dividing up an undeveloped 13.994 acre tract into 64 single-family lots. Public improvements within the subdivision (streets, drainage, and other utilities) will be dedicated to the City upon their completion.*

- Sec. 212.010. Standards for Approval

- (a) The municipal authority responsible for approving plats shall approve a plat if:
- (1) it conforms to the general plan of the municipality and its current and future streets, alleys, parks, playgrounds, and public utility facilities;

*The preliminary plat conforms to the Future Land Use Plan, which is designated Neighborhood Residential for this area.*

- (2) it conforms to the general plan for the extension of the municipality and its roads, streets, and public highways within the municipality and in its extraterritorial jurisdiction, taking into account access to and extension of sewer and water mains and the instrumentalities of public utilities;

*The plat conforms to the adopted Transportation Master Plan. The extension of Sterling Drive will be dedicated with this plat. The plat also conforms with the Capital Improvement Plan and will install public extensions of the water and wastewater infrastructure.*

- (3) a bond required under Section 212.0106, if applicable, is filed with the municipality; and

*Required improvements and bonds will be furnished before the approval of the Final Plat.*

- (4) it conforms to any rules adopted under Section 212.002.

*The preliminary plat complies with the requirements of the adopted Subdivision Ordinance.*

#### Code of Ordinances Chapter 10 – Subdivisions

- Section 4.10 – Standard Procedure – Preliminary Plat

4.10.1. The subdivider shall submit a preliminary plat of the entire area being subdivided. Prior to the plat being placed before the Commission for consideration, the plat must be accepted as administratively complete by the Director of Planning and Development. A plat that contains the detailed information set forth in paragraphs 4.10.1 and 4.10.2 is considered administratively complete.

*Planning and Engineering staff have reviewed the Pecan Park Section 1A Preliminary Plat for compliance with subdivision and utility standards and have deemed the plat administratively complete.*

**STAFF RECOMMENDATION:**

Consider action to recommend approval of the Pecan Park, Section 1A Preliminary Plat, being 13.994 acres out of the Mozea Rousseau Survey, Abstract 56, located east of the future extension of Sterling Drive, within the city limits of Bastrop, Texas and forward to the next available City Council meeting.

**ATTACHMENTS:**

Exhibit A: Preliminary Plat

Attachment 1: Location Map

Attachment 2: Surrounding Property Owner Notification

# THE PRELIMINARY PLAT OF PECAN PARK SECTION 1A

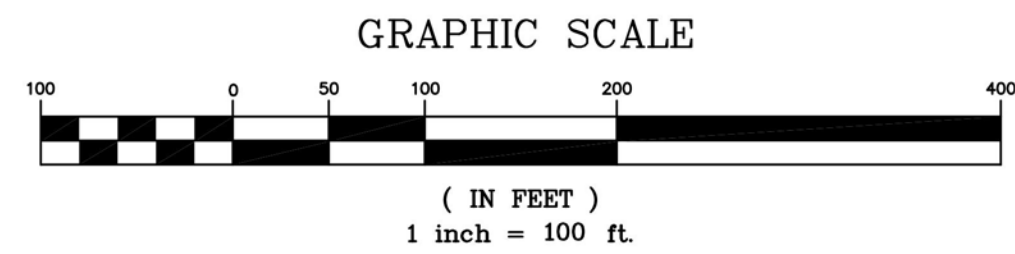
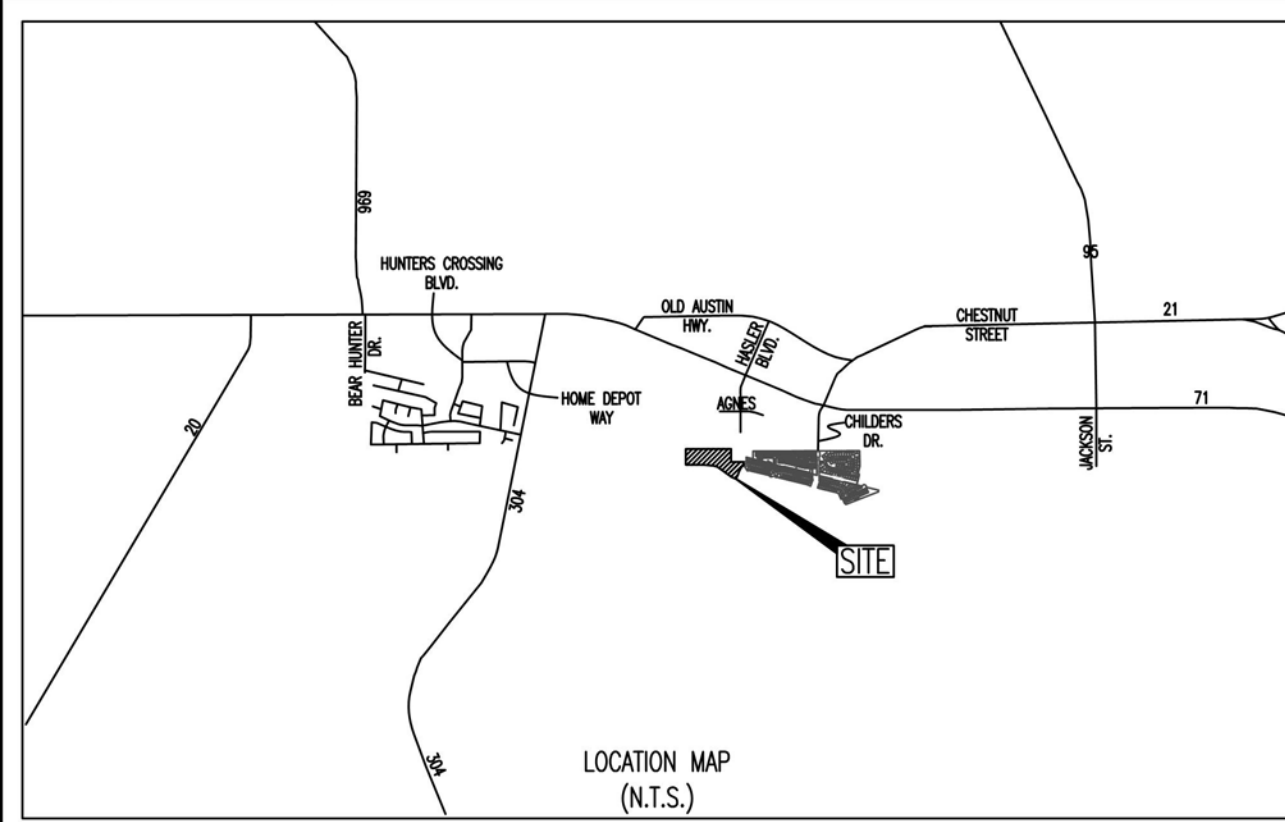

SCALE: 1" = 100'

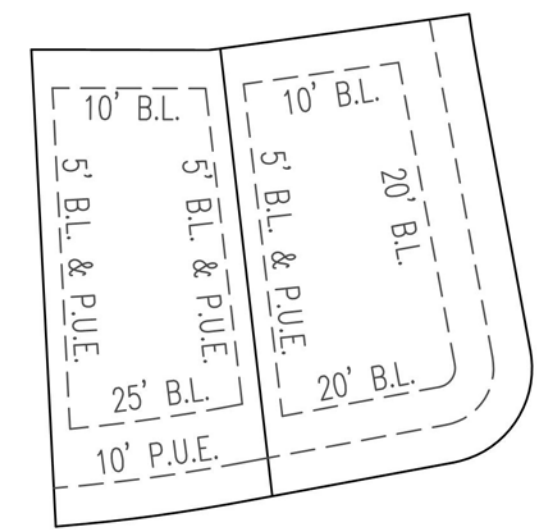
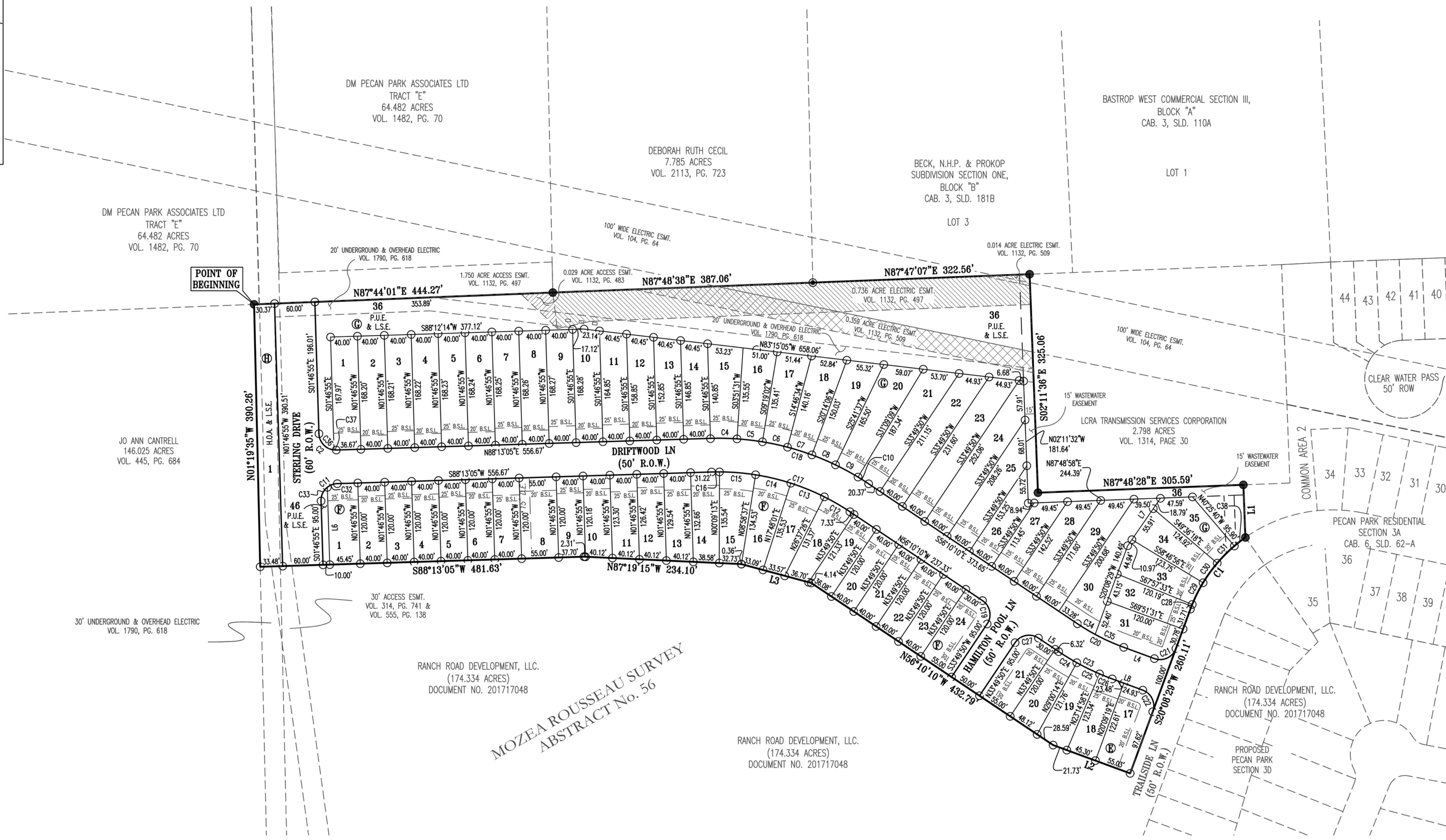

**BUILDING LINE & P.U.E. DETAIL**

- LEGEND**
- 1/2" CAPPED IRON ROD SET
  - CAPPED IRON ROD FOUND (UNLESS OTHERWISE NOTED)
  - ⊙ 1/2" IRON PIPE FOUND
  - 2 LOT NUMBER
  - Ⓐ BLOCK LETTER
  - H.O.A. HOME OWNERS ASSOCIATION
  - L.S.E. LANDSCAPE EASEMENT
  - P.U.E. PUBLIC UTILITY EASEMENT

**LINEAR FOOTAGE OF RIGHT-OF-WAY**

STREET	RIGHT-OF-WAY	LENGTH (FT)	TYPE
STERLING DRIVE	60' R.O.W.	391 FT	COLLECTOR
DRIFTWOOD LANE	50' R.O.W.	1,345 FT	LOCAL
HAMILTON POOL LANE	50' R.O.W.	120 FT	LOCAL
<b>TOTAL</b>		<b>1,856 FT</b>	

DATE: MAY 29, 2018  
OWNER:  
RANCH ROAD DEVELOPMENT, LLC.  
SCOTT MILLER  
3140 DYER STREET, SUITE 624  
DALLAS, TEXAS 75275

ENGINEER & SURVEYOR:  
CARLSON, BRIGANCE & DOERING, Inc.  
5501 WEST WILLIAM CANNON  
AUSTIN, TX 78749  
(512) 280-5160  
(512) 280-5165 fax

TOTAL ACREAGE: 13.994 ACRES  
SURVEY: MOZEA ROUSSEAU SURVEY, ABSTRACT No. 56

LANDSCAPE, D.E. LOTS: 3 TOTAL: 2.791 ACRES  
RESIDENTIAL LOTS: 64 TOTAL: 8.964 ACRES

NO. OF BLOCKS: 3 TOTAL: 2.239 ACRES  
R.O.W.:

STATE OF TEXAS )  
COUNTY OF TRAVIS ) KNOW ALL MEN BY THESE PRESENTS:

I, CHARLES R. BRIGANCE, JR., P.E. DO HEREBY CERTIFY THAT THE STREETS AND DRAINAGE DESIGN, AS SHOWN HEREON, COMPLIES WITH THE SUBDIVISION REGULATIONS FOR THE CITY OF BASTROP, AND THAT NO PORTION OF THIS PROPERTY IS WITHIN THE 100 YEAR FLOOD PLAIN AS SHOWN HEREON.

ENGINEERING BY: CHARLES R. BRIGANCE, JR., P.E. NO. 64346  
CARLSON, BRIGANCE & DOERING, INC.  
5501 WEST WILLIAM CANNON DRIVE  
AUSTIN, TEXAS 78749



STATE OF TEXAS )  
COUNTY OF TRAVIS ) KNOW ALL MEN BY THESE PRESENTS:

THAT I, AARON V. THOMASON, DO HEREBY CERTIFY THAT I PREPARED THIS PLAT FROM AN ACTUAL AND ACCURATE ON-THE-GROUND SURVEY OF THE LAND AND THAT THE CORNER MONUMENTS SHOWN THEREON WERE PROPERLY PLACED UNDER MY PERSONAL SUPERVISION, IN ACCORDANCE WITH THE SUBDIVISION REGULATION OF THE CITY OF BASTROP, BASTROP COUNTY, TEXAS. ALL EASEMENTS OF RECORD HAVE BEEN IDENTIFIED ON THIS PLAT TO THE BEST OF MY KNOWLEDGE.

SURVEYED BY: AARON V. THOMASON ~ R.P.L.S. NO. 6214  
CARLSON, BRIGANCE & DOERING, INC.  
5501 WEST WILLIAM CANNON DRIVE  
AUSTIN, TEXAS 78749



APPROVED ON THIS \_\_\_\_\_ DAY OF \_\_\_\_\_, 20\_\_\_\_ A.D., BY THE CITY COUNCIL OF THE CITY OF BASTROP.

APPROVED: \_\_\_\_\_ ATTEST: \_\_\_\_\_  
CONNIE SCHROEDER, MAYOR OF THE CITY OF BASTROP, TEXAS CITY SECRETARY, CITY OF BASTROP, TEXAS

SHEET NO. 1 OF 2



**Carlson, Brigance & Doering, Inc.**  
FIRM ID #F3791 REG. # 10024900  
Civil Engineering Surveying  
5501 West William Cannon Austin, Texas 78749  
Phone No. (512) 280-5160 Fax No. (512) 280-5165

# THE PRELIMINARY PLAT OF PECAN PARK SECTION 1A

**FIELD NOTES**

BEING ALL THAT CERTAIN 13.994 ACRE TRACT OF LAND OUT OF AND A PART OF THE MOZEA ROUSSEAU SURVEY, ABSTRACT NUMBER 56, SITUATED IN BASTROP COUNTY, TEXAS, SAID TRACT OF LAND BEING MORE PARTICULARLY DESCRIBED AS BEING A PORTION OF THAT CERTAIN 174.334 ACRE TRACT OF LAND, CONVEYED TO RANCH ROAD DEVELOPMENT, LLC, IN DOCUMENT NUMBER 201717048, OFFICIAL PUBLIC RECORDS, BASTROP COUNTY, TEXAS, SAID 13.994 ACRE TRACT OF LAND BEING MORE FULLY DESCRIBED BY METES AND BOUNDS AS FOLLOWS:

BEGINNING, AT A CAPPED IRON ROD FOUND AT THE NORTHEAST LINE OF A CALLED 146.025 ACRE TRACT OF LAND CONVEYED TO JO ANN CANTRELL IN VOLUME 445, PAGE 694, DEED RECORDS OF BASTROP COUNTY, TEXAS, SAME BEING IN THE SOUTH LINE OF A CALLED 64.482 ACRE TRACT OF LAND CONVEYED TO DM PECAN PARK ASSOCIATES, LTD. IN VOLUME 1482, PAGE 70, OFFICIAL PUBLIC RECORDS OF BASTROP COUNTY, TEXAS, ALSO BEING THE NORTHWEST CORNER OF SAID 174.334 ACRE TRACT OF LAND, FOR THE NORTHWEST CORNER AND THE POINT OF BEGINNING OF THE HEREIN DESCRIBED TRACT OF LAND,

THENCE, N87°44'01"E, WITH THE NORTH LINE OF SAID 174.334 ACRE TRACT OF LAND AND THE SOUTH LINE OF SAID 64.482 ACRE TRACT OF LAND, A DISTANCE OF 444.27 FEET TO A CAPPED IRON ROD FOUND AT THE SOUTHEAST CORNER OF SAID 64.482 ACRE TRACT OF LAND, SAME BEING AT THE SOUTHWEST CORNER OF A CALLED 7.785 ACRE TRACT OF LAND CONVEYED TO DEBORAH RUTH CEOL IN VOLUME 2113, PAGE 723, OFFICIAL PUBLIC RECORDS OF BASTROP COUNTY, TEXAS, FOR A CORNER OF THE HEREIN DESCRIBED TRACT OF LAND,

THENCE, N87°48'38"E, WITH THE NORTH LINE OF SAID 174.334 ACRE TRACT OF LAND AND THE SOUTH LINE OF SAID 7.785 ACRE TRACT OF LAND, A DISTANCE OF 387.06 FEET TO A CAPPED IRON ROD FOUND AT THE SOUTHWEST CORNER OF SAID 7.785 ACRE TRACT OF LAND, SAME BEING AT THE SOUTHWEST CORNER OF LOT 3, BLOCK B, BECK, N.H.P. & PROKOP SUBDIVISION, SECTION ONE, RECORDED IN CABINET 3, SLIDE 181B, PLAT RECORDS OF BASTROP COUNTY, TEXAS, FOR A CORNER OF THE HEREIN DESCRIBED TRACT OF LAND,

THENCE, N87°47'07"E, WITH THE NORTH LINE OF SAID 174.334 ACRE TRACT OF LAND AND THE SOUTH LINE OF SAID LOT 3, BLOCK B, A DISTANCE OF 322.56 FEET TO A CAPPED IRON ROD FOUND IN THE SOUTH LINE OF SAID LOT 3, BLOCK B, SAME BEING AT THE NORTHWEST CORNER OF A CALLED 2.798 ACRE TRACT OF LAND CONVEYED TO LCRA TRANSMISSION SERVICES CORPORATION IN VOLUME 1314, PAGE 30, OFFICIAL PUBLIC RECORDS OF BASTROP COUNTY, TEXAS, FOR THE NORTH-EAST CORNER OF THE HEREIN DESCRIBED TRACT OF LAND,

THENCE, WITH THE COMMON LINE OF SAID 174.334 ACRE TRACT OF LAND AND SAID 2.798 ACRE TRACT OF LAND, THE FOLLOWING TWO (2) COURSES AND DISTANCES, NUMBERED 1 AND 2,

- 1) S02°11'36"E, A DISTANCE OF 325.06 FEET TO A CAPPED IRON ROD FOUND FOR AN INTERIOR CORNER OF THE HEREIN DESCRIBED TRACT OF LAND, AND
- 2) N87°48'28"E, A DISTANCE OF 305.59 FEET TO A CAPPED IRON ROD FOUND FOR AN EASTERN EXTERIOR CORNER OF THE HEREIN DESCRIBED TRACT OF LAND, BEING IN THE SOUTH LINE OF SAID 2.798 ACRE TRACT OF LAND, SAME BEING AT AN INTERIOR CORNER OF COMMON AREA 2, PECAN PARK RESIDENTIAL, SECTION 3A, RECORDED IN CABINET 6, SLIDE 62-A, PLAT RECORDS OF BASTROP COUNTY, TEXAS,

THENCE, S02°11'02"E, WITH A WEST LINE OF SAID COMMON AREA 2 AND AN EAST LINE OF SAID 174.334 ACRE TRACT OF LAND, A DISTANCE OF 78.28 FEET TO A CAPPED IRON ROD FOUND AT THE SOUTHWEST CORNER OF SAID COMMON AREA 2, SAME BEING AT AN INTERIOR CORNER OF SAID 174.334 ACRE TRACT OF LAND, ALSO BEING AT THE WESTERMOST TERMINUS OF TRAILSIDE LANE (50' R.O.W.), FOR A SOUTHERN EAST CORNER OF THE HEREIN DESCRIBED TRACT OF LAND, AND ALSO BEING A THE BEGIN POINT OF CURVATURE OF A CURVE TO THE LEFT,

THENCE, OVER AND ACROSS SAID 174.334 ACRE TRACT OF LAND THE FOLLOWING SEVEN (7) COURSES AND DISTANCES, NUMBERED 1 THROUGH 7,

- 1) ALONG SAID CURVE TO THE LEFT, HAVING A RADIUS OF 225.00, AN ARC LENGTH OF 136.35 FEET, AND A CHORD THAT BEARS S37°30'07"W, A DISTANCE OF 134.27 FEET TO A CAPPED IRON ROD SET STAMPED "CBD SETSTONE" FOR CORNER,
- 2) S20°08'29"W, A DISTANCE OF 260.11 FEET TO A CAPPED IRON ROD SET STAMPED "CBD SETSTONE" FOR THE SOUTHERNMOST CORNER OF THE HEREIN DESCRIBED TRACT OF LAND,
- 3) N69°50'41"W, A DISTANCE OF 122.06 FEET TO A CAPPED <sup>1</sup>/<sub>2</sub>" IRON ROD SET STAMPED "CBD SETSTONE" FOR AN EXTERIOR CORNER OF THE HEREIN DESCRIBED TRACT OF LAND,
- 4) N56°10'10"W, A DISTANCE OF 432.79 FEET TO A CAPPED IRON ROD SET STAMPED "CBD SETSTONE" FOR AN INTERIOR CORNER OF THE HEREIN DESCRIBED TRACT OF LAND,
- 5) N74°52'47"W, A DISTANCE OF 107.86 FEET TO A CAPPED IRON ROD SET STAMPED "CBD SETSTONE" FOR AN INTERIOR CORNER OF THE HEREIN DESCRIBED TRACT OF LAND,
- 6) N87°19'15"W, A DISTANCE OF 234.10 FEET TO A CAPPED IRON ROD SET STAMPED "CBD SETSTONE" FOR AN INTERIOR CORNER OF THE HEREIN DESCRIBED TRACT OF LAND, AND
- 7) S88°13'05"W, A DISTANCE OF 481.63 FEET TO A CAPPED IRON ROD SET STAMPED "CBD SETSTONE" FOR THE SOUTHWEST CORNER OF THE HEREIN DESCRIBED TRACT OF LAND, SAME BEING IN THE EAST LINE OF THE AFOREMENTIONED 146.025 ACRE TRACT OF LAND,

THENCE, N01°19'35"W, A DISTANCE OF 390.26 FEET TO THE POINT OF BEGINNING AND CONTAINING 13.994 ACRES OF LAND.

Line Table		
Line #	Length	Direction
L1	78.28	S02°11'02"E
L2	122.06	N69°50'41"W
L3	107.86	N74°52'47"W
L4	48.38	N69°50'41"W
L5	36.32	S56°10'10"E
L6	115.00	S01°46'55"E
L7	85.95	N34°36'50"E
L8	48.41	S69°50'41"E

Curve Table						
Curve #	Length	Radius	Chord Direction	Chord Length	Tangent	DELTA
C1	136.35	225.00	S37°30'07"W	134.27	70.34	34°43'17"
C2	39.27	25.00	N46°46'55"W	35.36	25.00	90°00'00"
C4	39.38	400.00	S88°57'42"E	39.36	19.71	5°36'26"
C5	38.11	400.00	S83°24'43"E	38.10	19.07	5°27'32"
C6	38.11	400.00	S77°57'12"E	38.10	19.07	5°27'32"
C7	38.11	400.00	S72°29'40"E	38.10	19.07	5°27'32"
C8	38.11	400.00	S67°02'08"E	38.10	19.07	5°27'32"
C9	38.11	400.00	S61°34'37"E	38.10	19.07	5°27'32"
C10	18.70	400.00	S57°30'31"E	18.69	9.35	2°40'40"
C11	39.27	25.00	N43°13'05"E	35.36	25.00	90°00'00"
C12	44.02	350.00	N59°46'22"W	43.99	22.04	7°12'24"
C13	53.90	350.00	N67°47'16"W	53.85	27.00	8°49'24"
C14	53.90	350.00	N76°36'41"W	53.85	27.00	8°49'24"
C15	53.90	350.00	N85°26'05"W	53.85	27.00	8°49'24"
C16	11.82	350.00	S89°11'09"W	11.82	5.91	1°56'08"
C17	217.54	350.00	S73°58'33"E	214.06	112.41	35°36'45"
C18	248.62	400.00	N73°58'33"W	244.64	128.47	35°36'45"
C19	39.27	25.00	N11°10'10"W	35.36	25.00	90°00'00"
C20	77.57	325.00	N63°00'26"W	77.39	38.97	13°40'30"
C21	39.28	25.00	N69°08'54"E	35.36	25.01	90°00'50"

Curve Table						
Curve #	Length	Radius	Chord Direction	Chord Length	Tangent	DELTA
C22	39.26	25.00	N24°51'06"W	35.35	24.99	89°59'10"
C23	89.50	375.00	S63°00'28"E	89.29	44.97	13°40'30"
C24	31.59	375.00	N68°34'58"W	31.58	15.80	4°49'36"
C25	37.66	375.00	N63°52'24"W	37.65	18.65	5°45'16"
C26	20.25	375.00	N68°17'51"W	20.25	10.13	3°05'39"
C27	39.27	25.00	S78°49'50"W	35.36	25.00	90°00'00"
C28	7.46	225.00	N21°05'28"E	7.46	3.73	1°53'58"
C29	36.04	225.00	N26°37'46"E	36.00	18.06	9°10'38"
C30	36.04	225.00	N35°48'23"E	36.00	18.06	9°10'38"
C31	36.04	225.00	N44°59'01"E	36.00	18.06	9°10'38"
C32	16.09	25.00	S69°46'59"W	15.81	8.33	36°52'12"
C33	23.18	25.00	S24°46'59"W	22.36	12.50	53°07'48"
C34	30.80	325.00	S58°53'03"E	30.79	15.41	5°25'46"
C35	46.77	325.00	S65°43'19"E	46.73	23.43	8°14'45"
C36	35.93	25.00	S42°57'07"E	32.91	21.86	82°20'24"
C37	3.34	25.00	S87°57'07"E	3.34	1.67	7°39'36"
C38	20.78	225.00	N52°13'03"E	20.77	10.40	5°17'26"

**FLOOD PLAIN NOTE:**

NO PORTION OF THIS TRACT LIES WITHIN A DESIGNATED FLOOD HAZARD AREA, THIS TRACT LIES IN ZONE X, AS SHOWN ON THE FEDERAL FLOOD INSURANCE ADMINISTRATION RATE MAP NO. 48021 C 0355E, FOR BASTROP COUNTY TEXAS, DATED JANUARY 19, 2006. COMMUNITY NUMBER 481193, AS MODIFIED BY CLOMR CASE # 06-06-8025R, DATED JULY 31, 2006.

**GENERAL NOTES:**

1. ALL SUBDIVISION PERMITS SHALL CONFORM TO THE CITY OF BASTROP CODE OF ORDINANCES, CONSTRUCTION STANDARDS, AND GENERALLY ACCEPTED ENGINEERING PRACTICES.
2. CONSTRUCTION PLANS AND SPECIFICATIONS FOR ALL SUBDIVISION IMPROVEMENTS SHALL BE REVIEWED AND ACCEPTED BY THE CITY OF BASTROP PRIOR TO ANY CONSTRUCTION WITHIN THE SUBDIVISION.
3. EROSION AND SEDIMENTATION CONTROLS CONSTRUCTED WITH THE SUBDIVISION ORDINANCE OF THE CITY OF BASTROP ARE REQUIRED FOR ALL CONSTRUCTION ON EACH LOT.
4. ALL WORK, INCLUDING SIGNS, SHALL COMPLY WITH THE CITY OF BASTROP ORDINANCES AND THE MEMO OF UNDERSTANDING FOR DEVELOPMENT OF LAND APPROVED BY BASTROP CITY COUNCIL, NOVEMBER 12, 2013
5. CITY ACCEPTANCE OF SUBDIVISION INFRASTRUCTURE OR FISCAL SURETY FOR SUBDIVISION CONSTRUCTION, IN A FORM ACCEPTABLE TO THE CITY OF BASTROP, SHALL BE PROVIDED PRIOR TO FINAL PLAT RECORDATION BY THE CITY.
6. BY APPROVING THIS PRELIMINARY PLAT, THE CITY OF BASTROP ASSUMES NO OBLIGATION TO CONSTRUCT ANY INFRASTRUCTURE IN CONNECTION WITH THIS SUBDIVISION. ANY SUBDIVISION INFRASTRUCTURE REQUIRED FOR THE DEVELOPMENT OF THE LOTS IN THIS SUBDIVISION IS THE SOLE RESPONSIBILITY OF THE DEVELOPER AND/OR THE OWNERS OF THE LOTS. FAILURE TO CONSTRUCT ANY REQUIRED INFRASTRUCTURE TO THE CITY STANDARDS MAY BE JUST CAUSE FOR THE CITY TO DENY APPLICATIONS FOR CERTAIN DEVELOPMENT PERMITS INCLUDING BUILDING PERMITS, SITE PLAN APPROVALS AND/OR CERTIFICATE OF OCCUPANCY.
7. NO LOT OR STRUCTURE SHALL BE OCCUPIED PRIOR TO THE APPLICANT SUBMITTING TO THE CITY OF BASTROP DOCUMENTATION OF SUBDIVISION/SITE REGISTRATION WITH THE TEXAS DEPARTMENT OF LICENSING AND REGULATIONS (TDLR) AND PROVIDE DOCUMENTATION OF REVIEW AND COMPLIANCE OF THE SUBDIVISION CONSTRUCTION PLANS WITH TEXAS ARCHITECTURAL BARRIERS ACT (TABA).
8. WATER IS PROVIDED BY THE CITY OF BASTROP.
9. WASTEWATER SERVICE IS PROVIDED BY THE CITY OF BASTROP.
10. ELECTRIC SERVICE WILL BE PROVIDED BY BLUEBONNET ELECTRIC.
11. GAS SERVICE WILL BE PROVIDED BY CENTERPOINT ENERGY.
12. CABLE SERVICE IS PROVIDED BY SPECTRUM.
13. NO LOT IN THIS SUBDIVISION SHALL BE OCCUPIED UNTIL CONNECTED TO THE APPROVED WATER DISTRIBUTION AND WASTEWATER COLLECTION FACILITIES
14. WASTEWATER AND WATER SYSTEMS SHALL CONFORM TO TCEQ (TEXAS COMMISSION ON ENVIRONMENTAL QUALITY).
15. DEVELOPER/OWNER SHALL BE SOLELY RESPONSIBLE FOR ALL RELOCATIONS AND MODIFICATIONS TO EXISTING UTILITIES.
16. FLOOD WARNING: THE DEGREE OF FLOOD WATER PROTECTION REQUIRED BY THE CITY OF BASTROP FLOOD DAMAGE PREVENTION ORDINANCE IS CONSIDERED REASONABLE FOR THE REGULATORY PURPOSES AND IS BASED ON SCIENTIFIC AND ENGINEERING CONSIDERATIONS. ON RARE OCCASIONS, GREATER FLOODS CAN AND WILL OCCUR AND FLOOD HEIGHTS MAY BE INCREASED BY MAN-MADE OR NATURAL CAUSES. ACCEPTANCE OF THIS PRELIMINARY PLAT BY THE CITY COUNCIL DOES NOT IMPLY THAT LAND OUTSIDE OF THE AREA OF SPECIAL FLOOD HAZARDS OR USES PERMITTED IN SUCH AREAS WILL BE FREE FROM FLOODING OR FLOOD DAMAGES. NOR SHALL ACCEPTANCE OF THIS PRELIMINARY PLAT CREATE LIABILITY ON THE PART OF THE CITY OF BASTROP OR ANY OFFICIAL OR EMPLOYEE THEREOF FOR ANY FLOOD DAMAGES THAT RESULT FROM RELIANCE ON THE INFORMATION CONTAINED WITHIN THIS PRELIMINARY PLAT OR ANY ADMINISTRATION DECISION LAWFULLY MADE HEREUNDER.
17. ALL DRAINAGE EASEMENTS, STORM WATER FACILITIES / FEATURE SHALL BE MAINTAINED BY THE PROPERTY OWNER OR HIS OR HER ASSIGNS.
18. ALL EASEMENTS OF RECORD AS INDICATED ON THE MOST RECENT TITLE RUN DATED: 09-06-2017, CONDUCTED BY CHICAGO TITLE INSURANCE COMPANY, TITLE COMMITMENT OF NO. 1736054-B0P ISSUED BY CHICAGO TITLE INSURANCE COMPANY FOR THIS PROPERTY ARE SHOWN ON THIS PRELIMINARY PLAT.
19. TEMPORARY OR PERMANENT EASEMENTS ARE TO BE PROVIDED AS REQUIRED AT THE CITY'S SOLE DISCRETION FOR OFF-SITE WATER, WASTEWATER AND DRAINAGE IMPROVEMENTS.
20. PROPERTY OWNERS SHALL PROVIDE FOR ACCESS TO ALL EASEMENTS AS MAY BE NECESSARY AND SHALL NOT PROHIBIT ACCESS BY GOVERNMENTAL AUTHORITIES.
21. IT IS THE RESPONSIBILITY OF EACH RESIDENTIAL BUILDER TO DESIGN AND CONSTRUCT A SUITABLE GRADING AND DRAINAGE SCHEME WHICH WILL CONVEY SURFACE WATER WITHOUT PONDING IN OR AROUND THE LOT, FROM ITS STRUCTURE TO THE DRAINAGE SYSTEM CONSTRUCTED BY THE SUBDIVISION DEVELOPER.
22. PUBLIC UTILITY AND DRAINAGE EASEMENTS WHERE SHOWN HEREON ARE INTENDED TO INDICATE AN EASEMENT FOR CONSTRUCTION, OPERATIONS AND MAINTENANCE OF PUBLIC UTILITIES AND DRAINAGE WAYS, INCLUDING BUT NOT LIMITED TO SANITARY SEWERS, FORCE MAINS, WATER LINES, TELEPHONE SIGNAL CONDUITS, ELECTRIC CONDUCTORS, DRAINAGE PIPES AND NATURAL GAS LINES.
23. EVIDENCE OF A MANDATORY OWNER'S ASSOCIATIONS RESPONSIBLE FOR THE MAINTENANCE OF ALL COMMON AREAS MUST BE SUBMITTED PRIOR TO THE RECORDING OF THE FINAL PLAT.
24. A VARIANCE HAS BEEN GRANTED FOR THE 50' SETBACK REQUIRED FOR THE LCRA HIGH VOLTAGE TRANSMISSION LINES PER THE MINUTES FOR THE BASTROP CITY COUNCIL MEETING DATED WEDNESDAY, NOVEMBER 12, 2014 IN ITEM B-1.
25. FOR PECAN PARK SECTIONS 3B-3E AND SECTION 1A, NO MORE THAN 38 RESIDENTIAL BUILDING PERMITS MAY BE ISSUED PRIOR TO A SECOND POINT OF ACCESS BEING PROVIDED. NO FINAL PLATS WILL BE RECORDED FOR THIS PLAT UNTIL PECAN PARK COMMERCIAL PHASE 8 IMPROVEMENTS ARE CONSTRUCTED AND IT IS RECORDED.
26. THIS PROJECT IS GOVERNED BY THE MEMORANDUM OF UNDERSTANDING DATED 12-12-2013; ZONING ORDINANCE 2015-15; AMENDED ZONING ORDINANCE 2017-14; AND IS SUBJECT TO THE PECAN PARK TRAFFIC IMPACT ANALYSIS DATED 9-22-2015 PREPARED BY ALLIANCE TRANSPORTATION GROUP.
27. BLOCK H, LOT 1, SHOULD NOT BE RESTRICTED TO PROHIBIT FUTURE STREET ACCESS TO THE WEST, IF APPROPRIATE.

SHEET NO. 2 OF 2



**Carlson, Brigance & Doering, Inc.**  
FIRM ID #F3791 ♦ REG. # 10024900

Civil Engineering 5501 West William Cannon Phone No. (512) 280-5160 ♦ Surveying Austin, Texas 78749 ♦ Fax No. (512) 280-5165



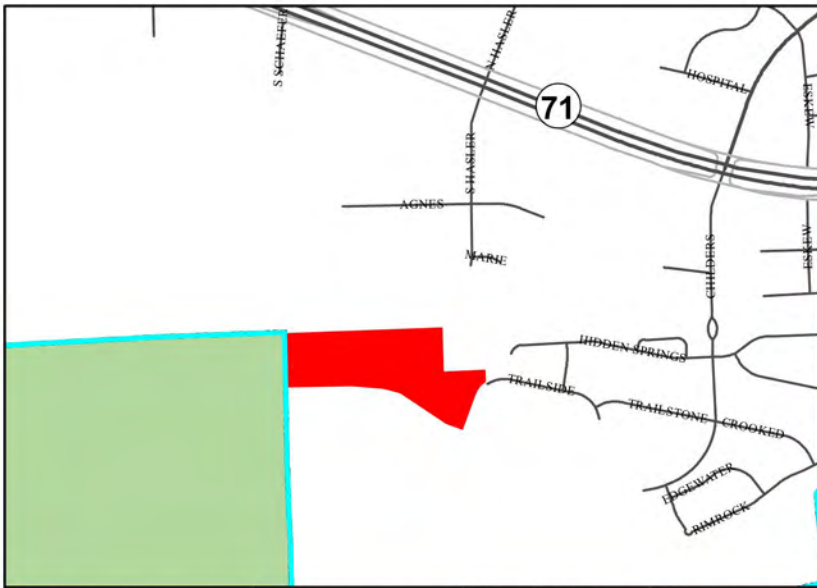

Location Map  
 Preliminary Plat  
 Pecan Park Section 1A

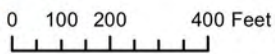

The accuracy and precision of this cartographic data is limited and should be used for information /planning purposes only. This data does not replace surveys conducted by registered Texas land surveyors nor does it constitute an "official" verification of zoning, land use classification, or other classification set forth in local, state, or federal regulatory processes. The City of Bastrop, nor any of its employees, do not make any warranty of merchantability and fitness for particular purpose, or assumes any legal liability or responsibility for the accuracy, completeness or usefulness of any such information, nor does it represent that its use would not infringe upon privately owned rights.

Date: 6/12/2018

**Notice of Pending Subdivision Approval  
City of Bastrop  
Planning & Zoning Commission and City Council**



Dear Property Owner:

The **Planning & Zoning Commission** will hold a meeting **Thursday, June 28, 2018 at 6:00 p.m.** and the **City Council** will hold a meeting on **Tuesday, July 10, 2018 at 6:30 p.m.** in the **City Hall Council Chambers** located at **1311 Chestnut Street, Bastrop, Texas** to consider approval of the Pecan Park, Section 1A Preliminary Plat, being 13.994 acres out of the Mozea Rousseau Survey, Abstract 56, located east of the future extension of Sterling Drive, within the city limits of Bastrop, Texas.

Owner/Applicant: Ranch Road Development, LLC/ Scott Miller

Address: East of the future extension of Sterling Drive, within the city limits of Bastrop, Texas.

Legal Description: 13.994 acres out of the Mozea Rousseau Survey, Abstract 56

Number of Lots: 64 residential, 4 landscape and easement lots

**The site location map and preliminary plat are attached for reference.**

As a property owner within 200 feet of the above referenced property, you are being notified of the upcoming meetings per the Bastrop Code of Ordinances Subdivision Regulations.

Property owners wishing to subdivide land must follow the rules within the City Subdivision Regulations, which can be read online at:

[https://library.municode.com/tx/bastrop/codes/code\\_of\\_ordinances?nodeId=CH10SU](https://library.municode.com/tx/bastrop/codes/code_of_ordinances?nodeId=CH10SU)

For more information on this project, you can contact the Planning & Development offices at (512) 332-8840, [plan@cityofbastrop.org](mailto:plan@cityofbastrop.org), or visit the office at 1311 Chestnut Street, Bastrop, Texas.

# PLANNING & ZONING STAFF REPORT



**MEETING DATE:** June 28, 2018

**Item:** 3D

**TITLE:**

Consider action to recommend approval of the Pecan Park, Sections 3B, 3C, 3D, & 3E Preliminary Plat, being 28.675 acres out of the Mozea Rousseau Survey, Abstract 56, located north of the extension of Childers Drive, within the city limits of Bastrop, Texas and forward to the next available City Council meeting.

**STAFF REPRESENTATIVE:**

Jennifer C. Bills, AICP, LEED AP, Assistant Planning Director

**ITEM DETAILS:**

Site Address:	North of the extension of Childers Drive (Attachment 1)
Total Acreage:	28.675 acres
Legal Description:	28.675 acres out of the Mozea Rousseau Survey, Abstract 56
Property Owner:	Ranch Road Development, LLC/Scott Miller
Agent Contact:	Carlson, Brigance, & Doering/Christine Methvin
Existing Use:	Vacant/Undeveloped
Existing Zoning:	Pecan Park Residential Planned Development
Planned Development District:	Single-Family Select (PD SFS)
Future Land Use:	Neighborhood Residential

**BACKGROUND/HISTORY:**

The applicant has submitted a new Preliminary Plat for the Pecan Park, Sections 3B, 3C, 3D, & 3E. The plat is creating 114 single-family detached lots, one drainage lot, and five landscape easement lots (Exhibit A). The single-family detached lots allowed under the Single-Family Select district of the Planned Development and have a minimum width of 50 feet and a minimum of 6,000 square feet in size. 4,381 linear feet of streets will be dedicated for Trailside Lane, Watercourse Way, Coldspring Loop, and Deep Eddy Cove, which will be 50-foot wide residential local collector rights-of-way. 1,346 linear feet of Childers Drive, which will be a 60-foot wide collector, will be dedicated with this section.

Traffic Impact and Streets

The Preliminary Plat proposes to extend Childers Drive, a collector street, westward to provide the main access for Section 3B-3E. Secondary access will be provided by a connection to Trailside Drive, which will connect to Section 1A. Sidewalks will be installed along all proposed streets, and will connect to the proposed neighborhood trail system.

Utilities

Water service (domestic and fire) will be provided by the City via water line extensions from existing infrastructure located on Childers Drive. These lines will be designed according to the City's construction standards, as well as the Texas Commission on Environmental Quality's (TCEQ) requirements.

Wastewater collection and treatment will also be provided by the City, and will require the installation of lines that will ultimately connect to an existing wastewater lift station.

There is an existing LCRA substation and electrical easement to the north of the proposed subdivision. The applicant received a subdivision variance on November 12, 2014 to eliminate the requirement for 50 foot setback from high voltage transmission lines.

#### Drainage

The Preliminary Plat proposes to install an underground storm sewer system designed to drain runoff generated from the development into an existing system located adjacent to Section 6B. The existing system was designed to accommodate this increase in peak flows, and ultimately connects to the Colorado River.

The proposed drainage system will be designed with a sufficient capacity to route flows from a 100-year design storm to the Colorado River. Due to the property's close proximity to the river, stormwater detention is not required.

Special flood hazard areas (SFHA) are located along the southern boundary of the proposed development, which appear to affect several proposed building lots. In order to ensure homes and other infrastructure are properly protected from flooding, these areas must be filled and developed in accordance with City of Bastrop and FEMA standards.

#### **PUBLIC COMMENTS:**

Notifications to adjacent property owners within 200 feet were mailed on June 11, 2018. (Attachment 3)

#### **POLICY EXPLANATION:**

All Preliminary Plats must be reviewed by the Planning & Zoning Commission and are then forwarded to City Council for approval.

#### Compliance with 2036 Comprehensive Plan:

- Future Land Use Plan - Neighborhood Residential: The Neighborhood Residential character area is for single-family residential subdivision development, associated amenities such as parks, trails, open spaces and public uses such as schools, fire stations, and more.

*This preliminary plat complies with the Future Land Use Plan. The plat includes 114 single-family lots that will provide single-family detached units. There are also six drainage and landscape easement lots to serve this area. This section is part of the Pecan Park development, in which the total development includes multiple phases that include parks, trails, and recreation facilities.*

- Objective 2.4.1: Invest in waste water system expansion in areas that promote infill and contiguous development.

*This development is within the City's wastewater service area and is vacant land immediately adjacent to existing development. This subdivision connects to existing wastewater lines and continues the system in an efficient manner*

- Goal 4.1.1 Provide a greater diversity of housing options in Bastrop while protecting the character of the City's existing neighborhoods.

*The Pecan Park Development includes six different residential lot standards. This plat utilizes the Single Family Select district, which allows 6,000 square foot lots with reduced*

rear and side setbacks to allow various single-family product types and with varied 20 and 25 foot front setbacks to provide visual appeal.

#### Local Government Code

- Sec. 212.002. Rules.

After a public hearing on the matter, the governing body of a municipality may adopt rules governing plats and subdivisions of land within the municipality's jurisdiction to promote the health, safety, morals, or general welfare of the municipality and the safe, orderly, and healthful development of the municipality.

*Bastrop adopted subdivision regulations in 1981. The Code of Ordinances, Chapter 10 – Subdivisions outlines the requirements for plats within the Bastrop city limits and Extra Territorial Jurisdiction (ETJ).*

#### Section 212.004 Plat Required

(a) The owner of a tract of land located within the limits or in the extraterritorial jurisdiction of a municipality who divides the tract in two or more parts to lay out a subdivision of the tract, including an addition to a municipality, to lay out suburban, building, or other lots, or to lay out streets, alleys, squares, parks, or other parts of the tract intended to be dedicated to public use or for the use of purchasers or owners of lots fronting on or adjacent to the streets, alleys, squares, parks, or other parts must have a plat of the subdivision prepared.

*The applicant has proposed dividing up an undeveloped 28.675 acre tract into 114 single-family lots. Public improvements within the subdivision (streets, drainage, and other utilities) will be dedicated to the City upon their completion.*

- Sec. 212.010. Standards for Approval

(a) The municipal authority responsible for approving plats shall approve a plat if:

- (1) it conforms to the general plan of the municipality and its current and future streets, alleys, parks, playgrounds, and public utility facilities;

*The preliminary plat conforms to the Future Land Use Plan, which is designated Neighborhood Residential for this area.*

- (2) it conforms to the general plan for the extension of the municipality and its roads, streets, and public highways within the municipality and in its extraterritorial jurisdiction, taking into account access to and extension of sewer and water mains and the instrumentalities of public utilities;

*The plat conforms to the adopted Transportation Master Plan. The extension of Childers Drive will be dedicated with this plat. The plat also conforms with the Capital Improvement Plan and will install public extensions of the water and wastewater infrastructure.*

- (3) a bond required under Section 212.0106, if applicable, is filed with the municipality; and

*Required improvements and bonds will be furnished before the approval of the Final Plat.*

- (4) it conforms to any rules adopted under Section 212.002.

*The preliminary plat complies with the requirements of the adopted Subdivision Ordinance.*

Code of Ordinances Chapter 10 – Subdivisions

- Section 4.10 – Standard Procedure – Preliminary Plat

4.10.1. The subdivider shall submit a preliminary plat of the entire area being subdivided. Prior to the plat being placed before the Commission for consideration, the plat must be accepted as administratively complete by the Director of Planning and Development. A plat that contains the detailed information set forth in paragraphs 4.10.1 and 4.10.2 is considered administratively complete.

*Planning and Engineering staff have reviewed the Pecan Park Sections 3B, 3C, 3D, & 3E Preliminary Plat for compliance with subdivision and utility standards and have deemed the plat administratively complete.*

**STAFF RECOMMENDATION:**

Consider action to recommend approval of the Pecan Park, Sections 3B, 3C, 3D, & 3E Preliminary Plat, being 28.675 acres out of the Mozea Rousseau Survey, Abstract 56, located north of the extension of Childers Drive, within the city limits of Bastrop, Texas and forward to the next available City Council meeting.

**ATTACHMENTS:**

- Exhibit A: Preliminary Plat
- Attachment 1: Location Map
- Attachment 2: Surrounding Property Owner Notification

# THE PRELIMINARY PLAT OF PECAN PARK SECTIONS 3B, 3C, 3D, & 3E

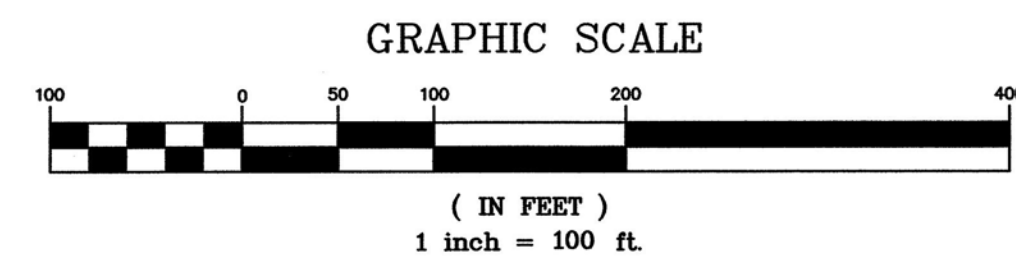
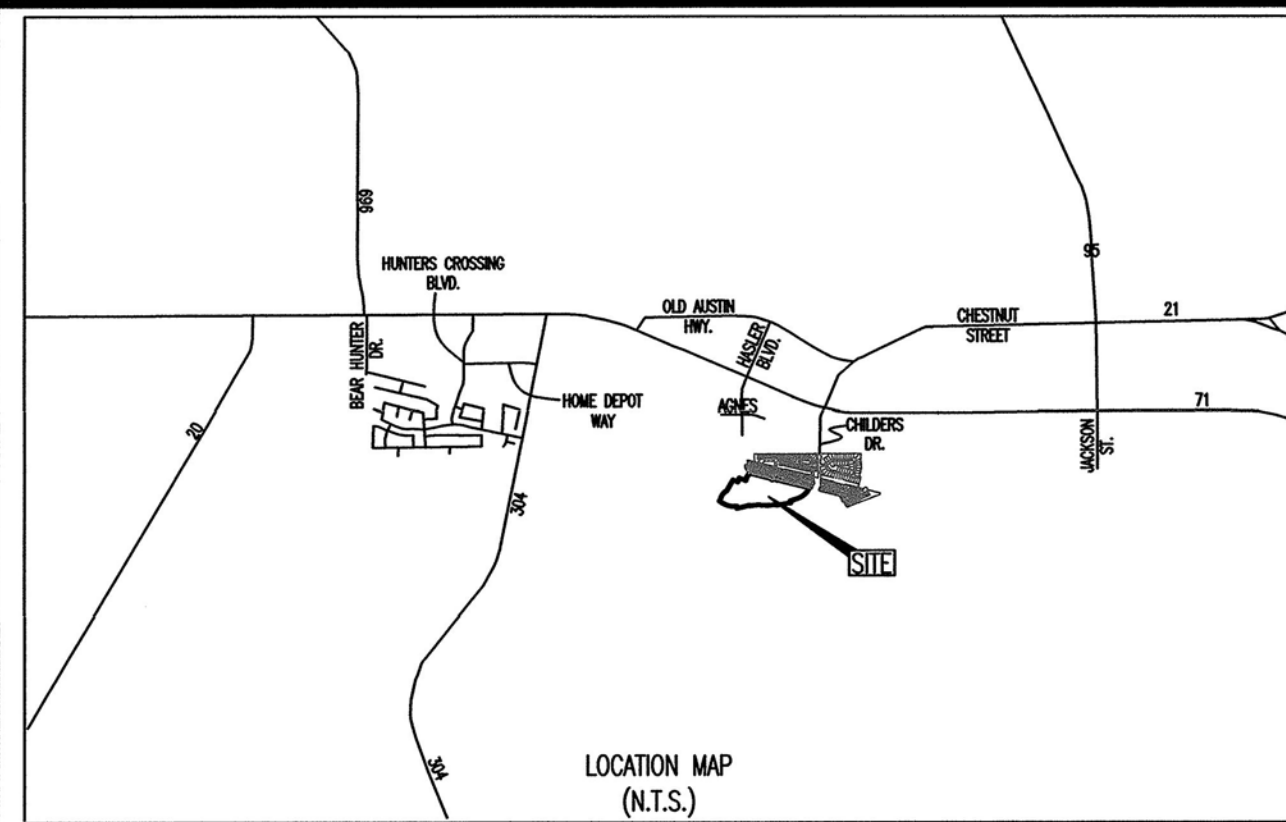

GRAPHIC SCALE

( IN FEET )  
1 inch = 100 ft.

SCALE: 1" = 100'



**FLOOD PLAN NOTE:**  
A PORTION OF THIS TRACT LIES WITHIN A DESIGNATED FLOOD HAZARD AREA, THIS TRACT LIES IN ZONE AE, AS SHOWN ON THE FEDERAL FLOOD INSURANCE ADMINISTRATION RATE MAP NO. 48021 C 0355E, FOR BASTROP COUNTY TEXAS, DATED JANUARY 19, 2008. COMMUNITY NUMBER 481193, AS MODIFIED BY CLOMR CASE # 06-06-0229, DATED JULY 31, 2006.

- GENERAL NOTES:**
- ALL SUBDIVISION PERMITS SHALL CONFORM TO THE CITY OF BASTROP CODE OF ORDINANCES, CONSTRUCTION STANDARDS, AND GENERALLY ACCEPTED ENGINEERING PRACTICES.
  - CONSTRUCTION PLANS AND SPECIFICATIONS FOR ALL SUBDIVISION IMPROVEMENTS SHALL BE REVIEWED AND ACCEPTED BY THE CITY OF BASTROP PRIOR TO ANY CONSTRUCTION WITHIN THE SUBDIVISION.
  - EROSION AND SEDIMENTATION CONTROLS CONSTRUCTED WITH THE SUBDIVISION ORDINANCE OF THE CITY OF BASTROP ARE REQUIRED FOR ALL CONSTRUCTION ON EACH LOT.
  - ALL WORK, INCLUDING SIGNS, SHALL COMPLY WITH THE CITY OF BASTROP ORDINANCES AND THE MEMO OF UNDERSTANDING FOR DEVELOPMENT OF LAND APPROVED BY BASTROP CITY COUNCIL, NOVEMBER 12, 2013.
  - CITY ACCEPTANCE OF SUBDIVISION INFRASTRUCTURE OR FISCAL SURETY FOR SUBDIVISION CONSTRUCTION, IN A FORM ACCEPTABLE TO THE CITY OF BASTROP, SHALL BE PROVIDED PRIOR TO FINAL PLAT RECORDED BY THE CITY.
  - BY APPROVING THIS PRELIMINARY PLAT, THE CITY OF BASTROP ASSUMES NO OBLIGATION TO CONSTRUCT ANY INFRASTRUCTURE IN CONNECTION WITH THIS SUBDIVISION. ANY SUBDIVISION INFRASTRUCTURE REQUIRED FOR THE DEVELOPMENT OF THE LOTS IN THIS SUBDIVISION IS THE SOLE RESPONSIBILITY OF THE DEVELOPER AND/OR THE OWNERS OF THE LOTS. FAILURE TO CONSTRUCT ANY REQUIRED INFRASTRUCTURE TO THE CITY STANDARDS MAY BE JUST CAUSE FOR THE CITY TO DENY APPLICATIONS FOR CERTAIN DEVELOPMENT PERMITS INCLUDING BUILDING PERMITS, SITE PLAN APPROVALS AND/OR CERTIFICATE OF OCCUPANCY.
  - NO LOT OR STRUCTURE SHALL BE OCCUPIED PRIOR TO THE APPLICANT SUBMITTING TO THE CITY OF BASTROP DOCUMENTATION OF SUBDIVISION INFRASTRUCTURE REGISTRATION WITH THE TEXAS DEPARTMENT OF LICENSING AND REGULATIONS (TDLR) AND PROVIDE DOCUMENTATION OF REVIEW AND COMPLIANCE OF THE SUBDIVISION CONSTRUCTION PLANS WITH TEXAS ARCHITECTURAL BARRIERS ACT (TABA).
  - WATER IS PROVIDED BY THE CITY OF BASTROP.
  - WASTEWATER SERVICE IS PROVIDED BY THE CITY OF BASTROP.
  - ELECTRIC SERVICE WILL BE PROVIDED BY BLUEBONNET ENERGY.
  - GAS SERVICE WILL BE PROVIDED BY CENTERPOINT ENERGY.
  - CABLE SERVICE IS PROVIDED BY SPECTRUM.
  - NO LOT IN THIS SUBDIVISION SHALL BE OCCUPIED UNTIL CONNECTED TO THE APPROVED WATER DISTRIBUTION AND WASTEWATER COLLECTION FACILITIES.
  - WASTEWATER AND WATER SYSTEMS SHALL CONFORM TO TCEQ (TEXAS COMMISSION ON ENVIRONMENTAL QUALITY).
  - DEVELOPER/OWNER SHALL BE SOLELY RESPONSIBLE FOR ALL RELOCATIONS AND MODIFICATIONS TO EXISTING UTILITIES.
  - FLOOD WARNING: THE DEGREE OF FLOOD WATER PROTECTION REQUIRED BY THE CITY OF BASTROP FLOOD DAMAGE PREVENTION ORDINANCE IS CONSIDERED REASONABLE FOR THE REGULATORY PURPOSES AND IS BASED ON SCIENTIFIC AND ENGINEERING CONSIDERATIONS. ON RARE OCCASIONS, GREATER FLOODS CAN OCCUR AND FLOOD HEIGHTS MAY BE INCREASED BY MAN-MADE OR NATURAL CAUSES. ACCEPTANCE OF THIS PRELIMINARY PLAT BY THE CITY COUNCIL DOES NOT IMPLY THAT LAND OUTSIDE OF THE AREA OF SPECIAL FLOOD HAZARDS OR USES PERMITTED IN SUCH AREAS WILL BE FREE FROM FLOODING OR FLOOD DAMAGES. NOR SHALL ACCEPTANCE OF THIS PRELIMINARY PLAT CREATE LIABILITY ON THE PART OF THE CITY OF BASTROP OR ANY OFFICIAL OR EMPLOYEE THEREOF FOR ANY FLOOD DAMAGES THAT RESULT FROM RELIANCE ON THE INFORMATION CONTAINED WITHIN THIS PRELIMINARY PLAT OR ANY ADMINISTRATION DECISION LAWFULLY MADE HEREUNDER.
  - ALL DRAINAGE EASEMENTS, STORM WATER FACILITIES / FEATURE SHALL BE MAINTAINED BY THE PROPERTY OWNER, OR HIS OR HER ASSIGNS.
  - ALL EASEMENTS OF RECORD AS INDICATED ON THE MOST RECENT TITLE RUN DATED: 09-06-2017, CONDUCTED BY CHICAGO TITLE INSURANCE COMPANY, TITLE COMMITMENT OF NO. 1730654-BOP ISSUED BY CHICAGO TITLE INSURANCE COMPANY FOR THIS PROPERTY ARE SHOWN ON THIS PRELIMINARY PLAT.
  - TEMPORARY OR PERMANENT EASEMENTS ARE TO BE PROVIDED AS REQUIRED AT THE CITY'S SOLE DISCRETION FOR OFF-SITE WATER, WASTEWATER AND DRAINAGE IMPROVEMENTS.
  - PROPERTY OWNERS SHALL PROVIDE ACCESS TO ALL EASEMENTS AS MAY BE NECESSARY AND SHALL NOT PROHIBIT ACCESS BY GOVERNMENTAL AUTHORITIES.
  - THE RESPONSIBILITY OF EACH RESIDENTIAL BUILDER TO DESIGN AND CONSTRUCT A SUITABLE GRADING AND DRAINAGE SCHEME WHICH WILL CONVEY SURFACE WATER WITHOUT PONDING IN OR AROUND THE LOT, FROM ITS STRUCTURE TO THE DRAINAGE SYSTEM CONSTRUCTED BY THE SUBDIVISION DEVELOPER.
  - PUBLIC UTILITY AND DRAINAGE EASEMENTS WHERE SHOWN HEREON ARE INTENDED TO INDICATE AN EASEMENT FOR CONSTRUCTION, OPERATION AND MAINTENANCE OF PUBLIC UTILITIES AND DRAINAGE WAYS, INCLUDING BUT NOT LIMITED TO SANITARY SEWERS, FORCE MAINS, WATER LINES, TELEPHONE SIGNAL CONDUITS, ELECTRIC CONDUCTORS, DRAINAGE PIPES AND NATURAL GAS LINES.
  - EVIDENCE OF A MANDATORY NOTICE OF ASSOCIATIONS RESPONSIBLE FOR THE MAINTENANCE OF ALL COMMON AREAS MUST BE SUBMITTED PRIOR TO THE RECORDING OF THE FINAL PLAT.
  - A VARIANCE AS BEEN GRANTED FOR THE 50' SETBACK REQUIRED FOR THE LGRA HIGH VOLTAGE TRANSMISSION LINES PER THE MINUTES FOR THE BASTROP CITY COUNCIL MEETING DATED WEDNESDAY, NOVEMBER 12, 2014 IN ITEM B-1.
  - NO MORE THAN 30 RESIDENTIAL BUILDING PERMITS MAY BE ISSUED PRIOR TO A SECOND POINT OF ACCESS BEING PROVIDED.
  - THIS PROJECT IS COVERED BY THE MEMORANDUM OF UNDERSTANDING DATED 12-12-2015, ZONING ORDINANCE 2015-15, AMENDED ZONING ORDINANCE 2017-14, AND IS SUBJECT TO THE PECAN PARK TRAFFIC IMPACT ANALYSIS DATED 9-22-2015 PREPARED BY ALLIANCE TRANSPORTATION GROUP.
  - THE CLOMR FOR THIS PROJECT WAS APPROVED BY FEMA 3-16-2018.

MOZEA ROUSSEAU SURVEY, ABSTRACT No. 56  
CLOMR TO REMOVE THIS AREA  
FROM THE FEMA FLOODPLAIN  
AS APPROVED BY FEMA 3-16-18

- LEGEND**
- 1/2" CAPPED IRON ROD SET
  - CAPPED IRON ROD FOUND (UNLESS OTHERWISE NOTED)
  - 2 LOT NUMBER
  - D.E. DRAINAGE EASEMENT
  - L.S.E. LANDSCAPE EASEMENT
  - APPROXIMATE FEMA 100 YEAR FLOODPLAIN

**LINEAR FOOTAGE OF RIGHT-OF-WAY**

CHILDRERS DRIVE	60' R.O.W.	40'-F	1,346	FT	COLLECTOR
TRAILSIDE LANE	50' R.O.W.	30'-F	1,592	FT	LOCAL
WATERCOURSE WAY	50' R.O.W.	30'-F	1,261	FT	LOCAL
COLDSRING LOOP	50' R.O.W.	30'-F	993	FT	LOCAL
DEEP EDDY COVE	50' R.O.W.	30'-F	535	FT	LOCAL
<b>TOTAL</b>			<b>5,733</b>	<b>FT</b>	

APPROVED ON THIS \_\_\_\_\_ DAY OF \_\_\_\_\_, 20\_\_\_\_ A.D., BY THE CITY COUNCIL OF THE CITY OF BASTROP.

APPROVED: \_\_\_\_\_ ATTEST: \_\_\_\_\_  
CONNIE SCHRÖDER, MAYOR OF THE CITY OF BASTROP, TEXAS CITY SECRETARY, CITY OF BASTROP, TEXAS

DATE: MARCH 26, 2018  
OWNER:  
RANCH ROAD DEVELOPMENT, LLC  
3140 DYER STREET, SUITE 624  
DALLAS, TEXAS 75275  
ENGINEER & SURVEYOR:  
CARLSON, BRIGANCE & DOERING, INC.  
5501 WEST WILLIAM CANNON  
AUSTIN, TX 78749  
(512) 280-5160  
(512) 280-5165 fax

TOTAL ACREAGE: 28.675 ACRES  
SURVEY: MOZEA ROUSSEAU SURVEY, ABSTRACT No. 56  
LANDSCAPE, D.E. LOTS: 1 TOTAL: 0.651 ACRES  
RESIDENTIAL LOTS: 114 TOTAL: 20.185 ACRES  
LANDSCAPE EASEMENT LOTS: 5 TOTAL: 0.667 ACRES  
NO. OF BLOCKS: 5  
R.O.W.: TOTAL: 7.148 ACRES

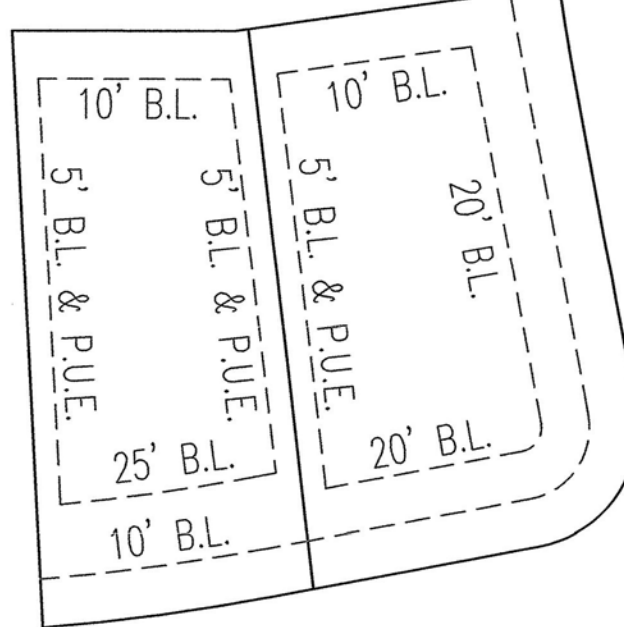

**BUILDING LINE & P.U.E. DETAIL**

STATE OF TEXAS )  
COUNTY OF TRAVIS ) KNOW ALL MEN BY THESE PRESENTS:  
I, CHARLES R. BRIGANCE, JR., P.E. DO HEREBY CERTIFY THAT THE STREETS AND DRAINAGE DESIGN, AS SHOWN HEREON, COMPLIES WITH THE SUBDIVISION REGULATIONS FOR THE CITY OF BASTROP, AND THAT THE 100 YEAR FLOOD PLAN IS AS SHOWN AND WILL BE COMPAINED WITHIN THE DRAINAGE EASEMENT AND OR DRAINAGE RIGHT-OF-WAY, AS SHOWN HEREON.  
ENGINEERING BY: *[Signature]* DATE: 5/23/18  
CHARLES R. BRIGANCE, JR., P.E. NO. 64346  
CARLSON, BRIGANCE & DOERING, INC.  
5501 WEST WILLIAM CANNON DRIVE  
AUSTIN, TEXAS 78749



STATE OF TEXAS )  
COUNTY OF TRAVIS ) KNOW ALL MEN BY THESE PRESENTS:  
THAT I, AARON V. THOMASON, DO HEREBY CERTIFY THAT I PREPARED THIS PLAT FROM AN ACTUAL AND ACCURATE ON-THE-GROUND SURVEY OF THE LAND AND THAT THE CORNER MONUMENTS SHOWN THEREON WERE PROPERLY PLACED UNDER MY PERSONAL SUPERVISION, IN ACCORDANCE WITH THE SUBDIVISION REGULATION OF THE CITY OF BASTROP, BASTROP COUNTY, TEXAS. ALL EASEMENTS OF RECORD WERE IDENTIFIED ON THIS PLAT TO THE BEST OF MY KNOWLEDGE.  
SURVEYED BY: *[Signature]* DATE: 23 MAR 2018  
AARON V. THOMASON ~ R.P.L.S. NO. 6214  
CARLSON, BRIGANCE & DOERING, INC.  
5501 WEST WILLIAM CANNON DRIVE  
AUSTIN, TEXAS 78749



SHEET NO. 1 OF 2



**Carlson, Brigance & Doering, Inc.**  
FIRM ID #F3791 REG. # 10024900  
Civil Engineering Surveying  
5501 West William Cannon Austin, Texas 78749  
Phone No. (512) 280-5160 Fax No. (512) 280-5165

# THE PRELIMINARY PLAT OF PECAN PARK SECTIONS 3B, 3C, 3D, & 3E

Curve Table						
Curve #	Length	Radius	Chord Direction	Chord Length	Tangent	DELTA
C1	42.15	175.00	S09°19'54"E	42.05	21.18	13°48'03"
C2	518.07	520.00	S50°55'17"W	496.91	262.83	57°05'00"
C3	228.07	1030.00	S85°48'23"W	227.60	114.50	12°41'12"
C4	225.01	720.00	S83°11'46"W	224.09	113.43	17°54'20"
C5	27.34	530.00	S75°43'18"W	27.34	13.67	25°27'20"
C6	352.38	470.00	N81°19'18"W	344.18	184.93	42°57'25"
C7	136.35	225.00	N37°30'07"E	134.27	70.34	34°43'17"
C8	39.32	25.00	S55°28'38"E	35.39	25.05	90°06'26"
C9	38.74	175.00	S04°11'51"E	38.66	19.45	12°40'55"
C10	38.27	25.00	S45°59'45"W	34.64	24.02	87°42'17"
C11	36.24	175.00	N84°13'08"W	36.18	18.19	11°51'58"
C12	29.09	25.00	N44°57'16"W	27.47	16.44	66°39'45"
C13	286.17	58.00	N27°01'44"E	72.45	46.39	282°41'46"
C14	46.60	225.00	N84°13'08"W	46.51	23.38	11°51'58"
C15	21.03	25.00	S60°03'25"E	20.41	11.18	48°11'23"
C16	160.64	50.00	S45°59'45"W	99.94	140.23	184°05'03"
C17	21.03	25.00	N21°57'05"W	20.41	11.18	48°11'23"
C18	49.80	225.00	S04°11'51"E	49.70	25.00	12°40'55"
C19	39.48	25.00	N34°13'43"E	35.50	25.21	90°27'57"
C20	39.77	25.00	N64°58'46"W	35.70	25.50	91°08'16"

Curve Table						
Curve #	Length	Radius	Chord Direction	Chord Length	Tangent	DELTA
C21	86.11	275.00	S01°34'11"E	85.76	43.41	17°56'28"
C22	38.61	225.00	N02°28'05"E	38.56	19.35	9°49'56"
C23	30.03	175.00	N02°28'05"E	29.99	15.05	9°49'56"
C24	101.77	325.00	S01°34'11"E	101.35	51.30	17°56'28"
C25	39.28	25.00	N34°28'00"E	35.36	25.01	90°00'00"
C26	88.85	475.00	N84°49'56"E	88.72	44.55	10°43'02"
C27	39.27	25.00	S44°48'33"E	35.36	25.00	90°00'00"
C28	60.02	325.00	S05°28'54"W	59.94	30.10	10°34'54"
C29	21.03	25.00	S34°52'03"W	20.41	11.18	48°11'23"
C30	162.65	50.00	N34°13'38"W	99.85	89.21	186°22'46"
C31	21.03	25.00	N76°40'40"E	20.41	11.18	48°11'23"
C32	21.03	25.00	S50°07'57"E	20.41	11.18	48°11'23"
C33	153.10	50.00	S61°42'27"W	99.92	126.71	175°26'36"
C34	21.03	25.00	N02°23'10"W	20.41	11.18	48°11'23"
C35	135.42	275.00	S07°36'06"W	134.05	68.11	28°12'51"
C36	37.71	25.00	N36°42'11"E	34.23	23.48	86°25'00"
C37	76.48	175.00	S70°05'01"W	76.46	38.28	5°39'18"
C38	39.28	25.00	S60°45'03"E	35.35	24.99	89°59'10"
C39	234.96	375.00	S02°11'30"W	231.13	121.48	35°53'59"
C40	106.05	175.00	S37°30'07"W	104.43	54.71	34°43'17"

Curve Table						
Curve #	Length	Radius	Chord Direction	Chord Length	Tangent	DELTA
C41	266.29	425.00	S02°11'30"W	261.95	137.68	35°53'57"
C42	39.28	25.00	N29°14'57"E	35.36	25.01	90°00'50"
C43	69.91	225.00	N83°09'28"E	69.63	35.24	17°48'11"
C44	30.77	25.00	S52°40'35"E	28.87	17.68	70°31'44"
C45	218.63	50.00	S37°19'24"W	81.65	70.71	250°31'46"
C46	85.45	275.00	N83°09'28"E	85.10	43.07	17°48'11"
C47	39.28	25.00	N69°45'03"W	35.35	24.99	89°59'10"
C48	40.56	25.00	N30°43'16"E	36.26	26.32	92°57'27"
C49	39.26	25.00	N55°32'00"W	35.35	24.99	89°59'10"
C50	98.20	525.00	N84°49'56"E	98.06	49.24	10°43'02"
C51	201.63	725.00	S82°13'25"W	200.98	101.47	15°56'05"
C52	39.28	25.00	S29°14'57"E	35.36	25.01	90°00'50"
C53	39.27	25.00	S60°45'25"E	35.35	25.00	89°59'54"
C54	243.76	780.00	S83°11'46"W	242.77	122.88	17°54'20"
C55	214.78	970.00	N85°48'23"E	214.54	107.83	12°41'12"
C56	39.27	25.00	N34°27'41"E	35.36	25.00	90°00'12"
C57	39.27	25.00	N45°11'27"E	35.36	25.00	90°00'00"
C58	69.26	375.00	S05°28'54"W	69.16	34.73	10°34'54"
C59	39.27	25.00	N34°13'38"W	35.36	25.00	90°00'00"
C60	34.50	25.00	S61°14'27"W	31.83	20.63	79°03'50"

Curve Table						
Curve #	Length	Radius	Chord Direction	Chord Length	Tangent	DELTA
C61	110.80	225.00	S07°36'06"W	109.68	56.55	28°12'51"
C62	37.71	25.00	S49°42'49"E	34.23	23.48	86°25'00"
C63	42.11	175.00	S88°30'04"W	42.10	21.06	3°06'47"
C64	25.01	58.00	S23°58'38"E	24.82	12.70	24°42'29"
C65	150.65	58.00	N69°15'27"E	111.73	207.89	148°49'21"
C66	32.15	58.00	N21°01'57"W	31.74	16.50	31°45'28"
C67	60.06	58.00	N86°34'43"W	57.42	33.04	89°20'04"
C68	18.45	50.00	N52°32'05"W	18.35	9.33	21°08'42"
C69	49.71	50.00	S88°24'44"W	47.69	27.13	56°57'40"
C70	21.27	50.00	S47°44'35"W	21.11	10.80	24°22'37"
C71	20.55	50.00	S23°46'54"W	20.40	10.42	23°32'47"
C72	50.66	50.00	S17°01'08"E	48.52	27.75	56°03'17"
C73	16.54	25.00	N27°05'54"W	16.24	8.58	37°53'45"
C74	4.49	25.00	N03°00'12"W	4.49	2.25	10°17'38"
C75	12.12	225.00	S00°36'03"W	12.11	6.06	3°05'07"
C76	37.69	225.00	S05°44'24"E	37.64	18.89	9°35'49"
C77	12.86	25.00	N04°11'36"E	12.71	6.57	28°27'50"
C78	26.41	25.00	N49°11'39"E	25.20	14.59	60°32'16"
C79	72.09	275.00	S03°01'51"E	71.88	36.25	15°01'09"
C80	14.02	275.00	S05°56'23"W	14.02	7.01	25°51'19"

Curve Table						
Curve #	Length	Radius	Chord Direction	Chord Length	Tangent	DELTA
C81	18.30	58.00	S74°43'03"W	18.22	9.22	18°04'24"
C82	15.72	25.00	N83°41'51"E	15.46	8.13	36°02'00"
C83	38.97	175.00	S78°28'15"W	38.97	19.49	25°52'27"
C84	37.52	175.00	S75°38'36"W	37.52	18.77	24°45'27"
C85	39.57	325.00	S03°54'46"W	39.55	19.81	6°58'33"
C86	47.15	325.00	S03°45'51"E	47.10	23.61	8°18'42"
C87	15.05	325.00	S09°12'49"E	15.05	7.53	23°39'13"
C88	48.93	475.00	N82°25'28"E	48.91	24.49	5°44'06"
C89	39.92	475.00	N87°46'59"E	39.91	19.97	4°48'56"
C90	48.35	325.00	S04°27'09"W	48.30	24.22	8°31'23"
C91	11.88	325.00	S09°44'36"W	11.88	5.84	20°32'37"
C92	2.40	25.00	S13°31'26"W	2.40	1.20	5°30'10"
C93	18.63	25.00	S37°37'08"W	18.20	9.77	42°41'13"
C94	38.55	50.00	N36°52'24"E	37.60	20.29	44°10'41"
C95	36.64	50.00	N06°12'26"W	35.82	19.18	41°58'58"
C96	37.36	50.00	N48°38'21"W	36.50	19.60	42°48'53"
C97	50.09	50.00	S81°17'05"W	48.03	27.38	57°24'13"
C98	2.14	25.00	N55°01'48"E	2.13	1.07	45°33'39"
C99	18.89	25.00	N79°07'29"E	18.45	9.92	43°17'44"
C100	32.21	50.00	N49°29'24"W	31.65	16.68	36°54'18"

Curve Table						
Curve #	Length	Radius	Chord Direction	Chord Length	Tangent	DELTA
C101	39.93	50.00	S89°10'37"W	38.88	21.10	45°45'39"
C102	36.88	50.00	S45°10'06"W	36.05	19.32	42°15'22"
C103	44.09	50.00	S01°13'13"E	42.67	23.59	50°31'16"
C104	15.03	25.00	N09°15'40"W	14.80	7.75	34°28'23"
C105	6.00	25.00	N14°50'02"E	5.99	3.01	13°45'00"
C106	45.48	275.00	S16°59'17"W	45.42	22.79	9°28'30"
C107	48.56	275.00	S07°10'31"W	48.50	24.34	10°07'02"
C108	41.38	275.00	S02°11'40"E	41.34	20.73	8°37'19"
C109	84.95	375.00	S09°16'05"E	84.77	42.66	12°58'47"
C110	87.01	375.00	S03°52'07"W	86.81	43.70	13°17'37"
C111	63.00	375.00	S15°19'42"W	62.93	31.57	9°37'33"
C112	81.00	175.00	S22°02'10"W	81.57	5.79	3°47'21"
C113	67.00	175.00	S39°23'48"W	63.33	48.42	30°55'50"
C114	94.48	175.00	S19°32'57"W	93.33	48.42	30°55'50"
C115	8.79	425.00	S19°32'57"W	8.79	4.39	11°11'04"
C116	50.48	425.00	S19°33'16"W	50.45	25.27	6°48'18"
C117	50.65	425.00	S08°44'17"W	50.62	25.35	6°48'40"
C118	61.64	425.00	S01°10'11"W	61.58	30.87	8°18'33"
C119	94.74	425.00	S09°22'17"E	94.55	47.57	12°46'22"
C120	43.51	225.00	N78°47'46"E	43.44	21.82	11°04'48"
C121	26.40	225.00	N88°41'51"E	26.39	13.22	6°43'23"

Curve Table						
Curve #	Length	Radius	Chord Direction	Chord Length	Tangent	DELTA
C124	16.09	50.00	N26°37'57"W	16.02	8.12	18°28'28"
C125	55.49	50.00	N67°38'37"W	52.68	30.99	63°34'53"
C126	32.58	50.00	S61°53'46"W	32.01	16.89	37°20'20"
C127	37.34	50.00	S21°50'05"W	36.47	19.59	42°47'01"
C128	33.64	50.00	S18°49'47"E	33.01	17.48	38°32'44"
C129	37.47	50.00	S59°34'10"E	36.80	19.66	42°56'01"
C130	6.03	50.00	S84°29'20"E	6.02	3.02	65°41'19"
C131	14.89	275.00	S89°29'31"E	14.89	7.45	3°06'08"
C132	46.12	275.00	N84°09'08"E	46.07	23.11	9°36'33"
C133	24.44	275.00	N76°48'07"E	24.43	12.23	5°05'30"
C134	3.59	25.00	N11°38'52"W	3.58	1.80	8°13'13"
C135	36.97	25.00	N34°49'52"E	33.69	22.80	84°44'14"
C136	36.16	25.00	N38°01'45"E	33.09	22.07	82°52'03"
C137	3.11	25.00	N06°58'21"W	3.11	1.56	7°08'10"
C138	37.45	525.00	N81°31'01"E	37.44	18.73	4°05'12"
C139	48.16	525.00	N86°11'18"E	48.14	24.10	5°15'22"
C140	12.59	525.00	N89°30'13"E	12.59	6.30	1°22'28"
C141	37.49	725.00	S88°42'34"W	37.49	18.75	25°46'46"
C142	59.19	725.00	S84°53'21"W	59.17	29.61	4°40'39"
C143	59.19	725.00	S80°12'41"W	59.17	29.61	4°40'40"

Curve Table						
Curve #	Length	Radius	Chord Direction	Chord Length	Tangent	DELTA
C144						



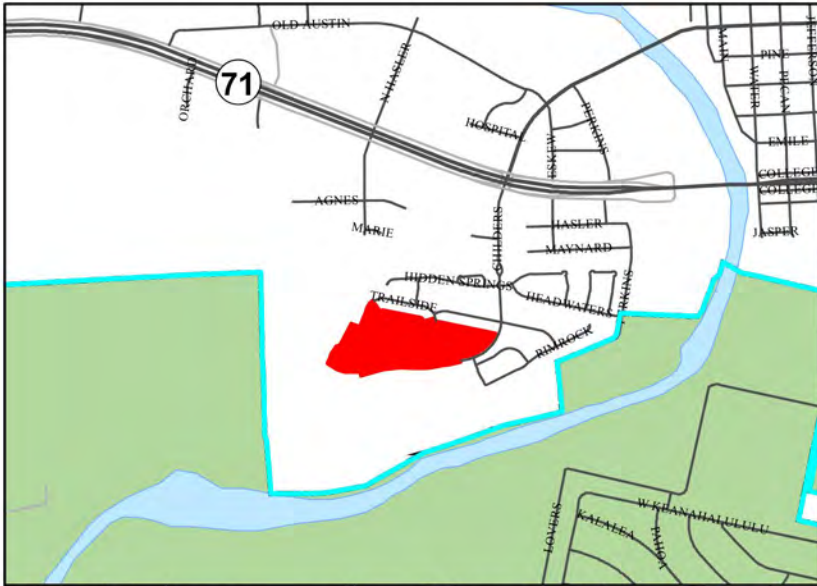

Location Map  
 Preliminary Plat  
 Pecan Park Sections 3B, 3C, 3D, 3E

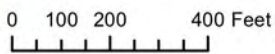

The accuracy and precision of this cartographic data is limited and should be used for information /planning purposes only. This data does not replace surveys conducted by registered Texas land surveyors nor does it constitute an "official" verification of zoning, land use classification, or other classification set forth in local, state, or federal regulatory processes. The City of Bastrop, nor any of its employees, do not make any warranty of merchantability and fitness for particular purpose, or assumes any legal liability or responsibility for the accuracy, completeness or usefulness of any such information, nor does it represent that its use would not infringe upon privately owned rights.

Date: 6/12/2018

**Notice of Pending Subdivision Approval  
City of Bastrop  
Planning & Zoning Commission and City Council**



Dear Property Owner:

The **Planning & Zoning Commission** will hold a meeting **Thursday, June 28, 2018 at 6:00 p.m.** and the **City Council** will hold a meeting on **Tuesday, July 10, 2018 at 6:30 p.m.** in the **City Hall Council Chambers** located at **1311 Chestnut Street, Bastrop, Texas** to consider approval of the Pecan Park, Section 3B, 3C, 3D, & 3E Preliminary Plat, being 28.675 acres out of the Mozea Rousseau Survey, Abstract 56, located north of the extension of Childers Drive, within the city limits of Bastrop, Texas.

Owner/Applicant: Ranch Road Development, LLC/ Scott Miller

Address: North of the extension of Childers Drive, within the city limits of Bastrop, Texas.

Legal Description: 28.675 acres out of the Mozea Rousseau Survey, Abstract 56

Number of Lots: 114 residential, 6 landscape and drainage easement lots

**The site location map and preliminary plat are attached for reference.**

As a property owner within 200 feet of the above referenced property, you are being notified of the upcoming meetings per the Bastrop Code of Ordinances Subdivision Regulations.

Property owners wishing to subdivide land must follow the rules within the City Subdivision Regulations, which can be read online at:

[https://library.municode.com/tx/bastrop/codes/code\\_of\\_ordinances?nodeId=CH10SU](https://library.municode.com/tx/bastrop/codes/code_of_ordinances?nodeId=CH10SU)

For more information on this project, you can contact the Planning & Development offices at (512) 332-8840, [plan@cityofbastrop.org](mailto:plan@cityofbastrop.org), or visit the office at 1311 Chestnut Street, Bastrop, Texas.

# PLANNING & ZONING COMMISSION

## STAFF REPORT

---



**MEETING DATE:** June 28, 2018

**ITEM:** 5A

**TITLE:**

Discussion with the future developers for the northeast corner of SH 95 and Chestnut Street for the rezoning of the existing Commercial Mixed Use and Commercial-2 zoning into one commercial district.

**STAFF REPRESENTATIVE:**

Jennifer C. Bills, AICP, LEED AP, Assistant Planning Director

**BACKGROUND/HISTORY:**

At the May 31, 2018, the Planning & Zoning Commission voted 5-2 to recommend denial of the request to rezone the northeast corner of SH 95 and Chestnut Street to C-1, Commercial 1, consisting of Lots 1 & 2 of the Lee-Jackson & Fowler Subdivision (1.717 acres) currently Form-based Code Character Zone CMU, Commercial Mixed Use, and 0.398 acres of Bastrop Town Tract Abstract 11 and 2.046 acres of Building Block 12 East of Water Street currently C-2, Commercial 2.

At the June 12, 2018 meeting, City Council reviewed the request, the recommendation of the P&Z and public comments and voted 4-0 to send the item back to P&Z to hold a workshop with the developer to discuss the vision for that corner and how the project could be accomplished under the requested zoning of Commercial 1, or under Commercial Mixed Use within the Form-based Code.

**ATTACHMENTS:**

- Attachment 1 – Zoning Map
- Attachment 2 – Future Land Use Plan
- Attachment 3 – Aerial Location Map

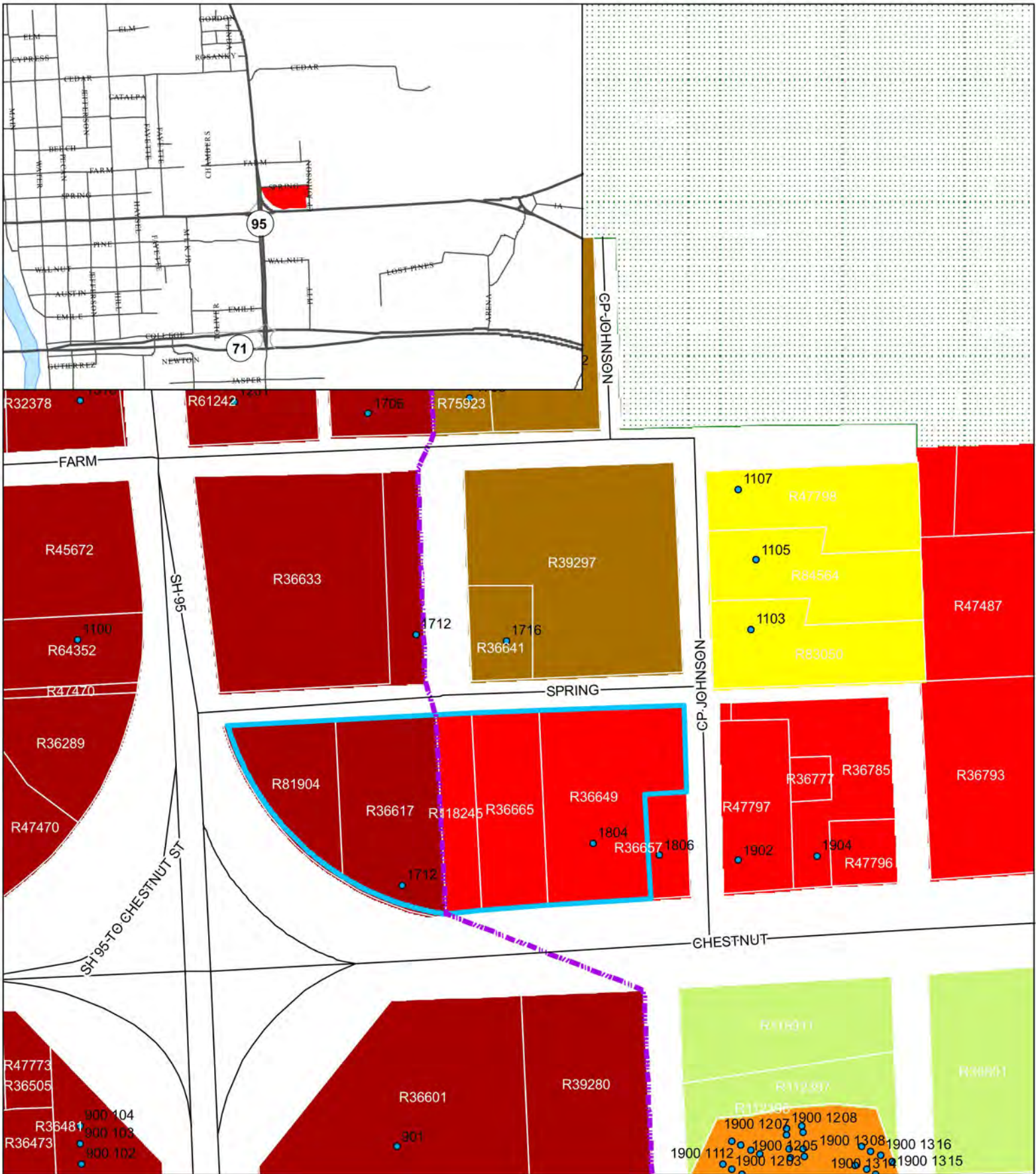

1 inch = 200 feet

**Attachment 1**  
**Zoning Map**  
**Zoning Map Amendment**  
**Bastrop Town Tract A11 0.398 Acres**  
**Building Block 112 E W ST 2.046 Acres**



The accuracy and precision of this cartographic data is limited and should be used for information planning purposes only. This data does not replace surveys conducted by registered Texas land surveyors nor does it constitute an "official" verification of zoning, land use classification, or other classification set forth in local, state, or federal regulatory processes. The City of Bastrop, nor any of its employees, do not make any warranty of merchantability and fitness for particular purpose, or assumes any legal liability or responsibility for the accuracy, completeness or usefulness of any such information, nor does it represent that its use would not infringe upon privately owned rights.

Date: 11/20/2017



- ### Legend
- #### Future Land Use
- Parks and Open Space
  - Rural Residential
  - Neighborhood Residential
  - Transitional Residential
  - Neighborhood Commercial
  - General Commercial
  - Professional Services
  - Downtown Bastrop\*
  - Public and Institutional
  - Industrial

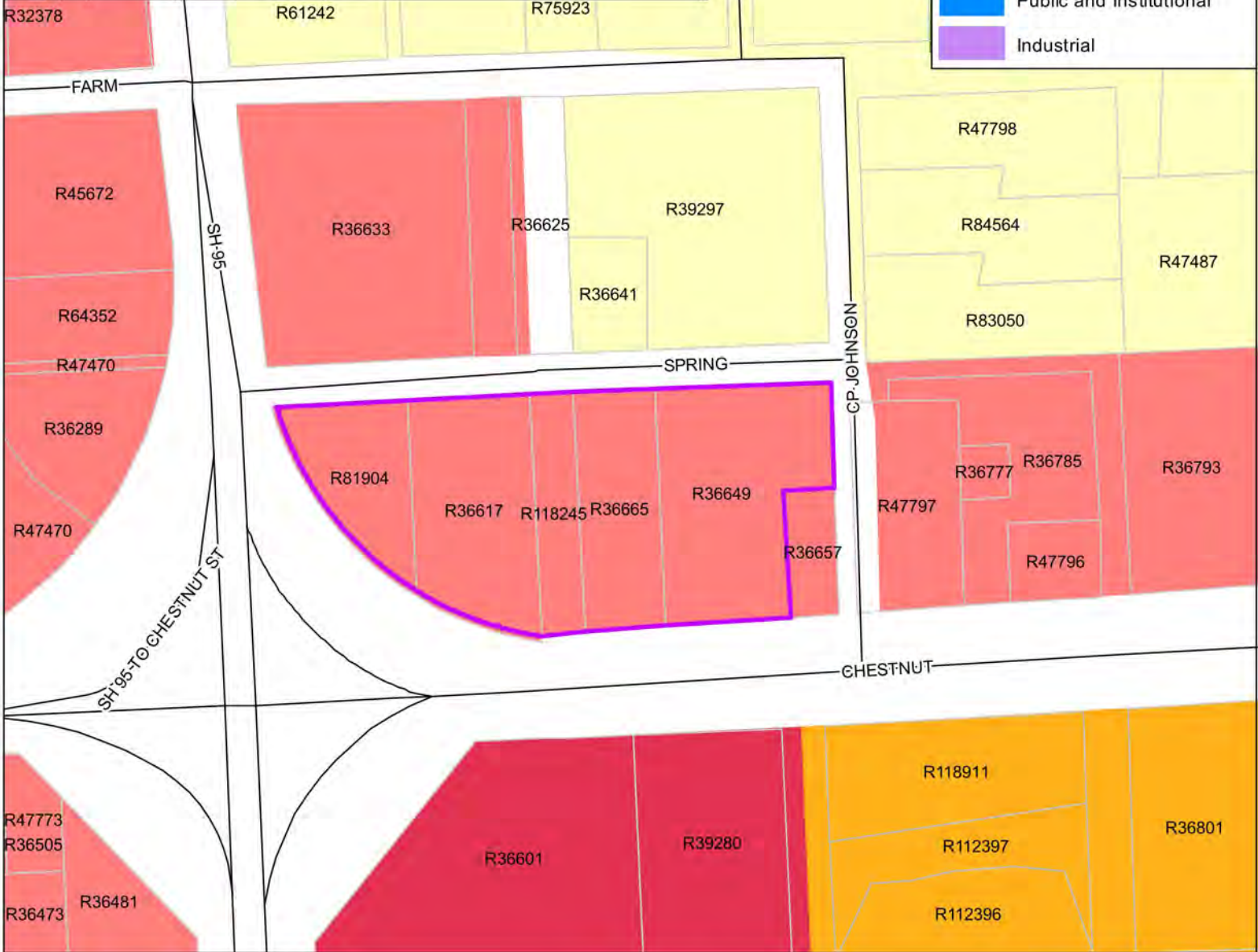

**Attachment 2**  
**Future Land Use Map**  
**Zoning Map Amendment**  
**Bastrop Town Tract A11 0.398 Acres**  
**Building Block 112 E W ST 2.046 Acres**

1 inch = 200 feet



The accuracy and precision of this cartographic data is limited and should be used for information planning purposes only. This data does not replace surveys conducted by registered Texas land surveyors nor does it constitute an "official" verification of zoning, land use classification, or other classification set forth in local, state, or federal regulatory processes. The City of Bastrop, nor any of its employees, do not make any warranty of merchantability and fitness for particular purpose, or assumes any legal liability or responsibility for the accuracy, completeness or usefulness of any such information, nor does it represent that its use would not infringe upon privately owned rights.

Date: 11/17/2017

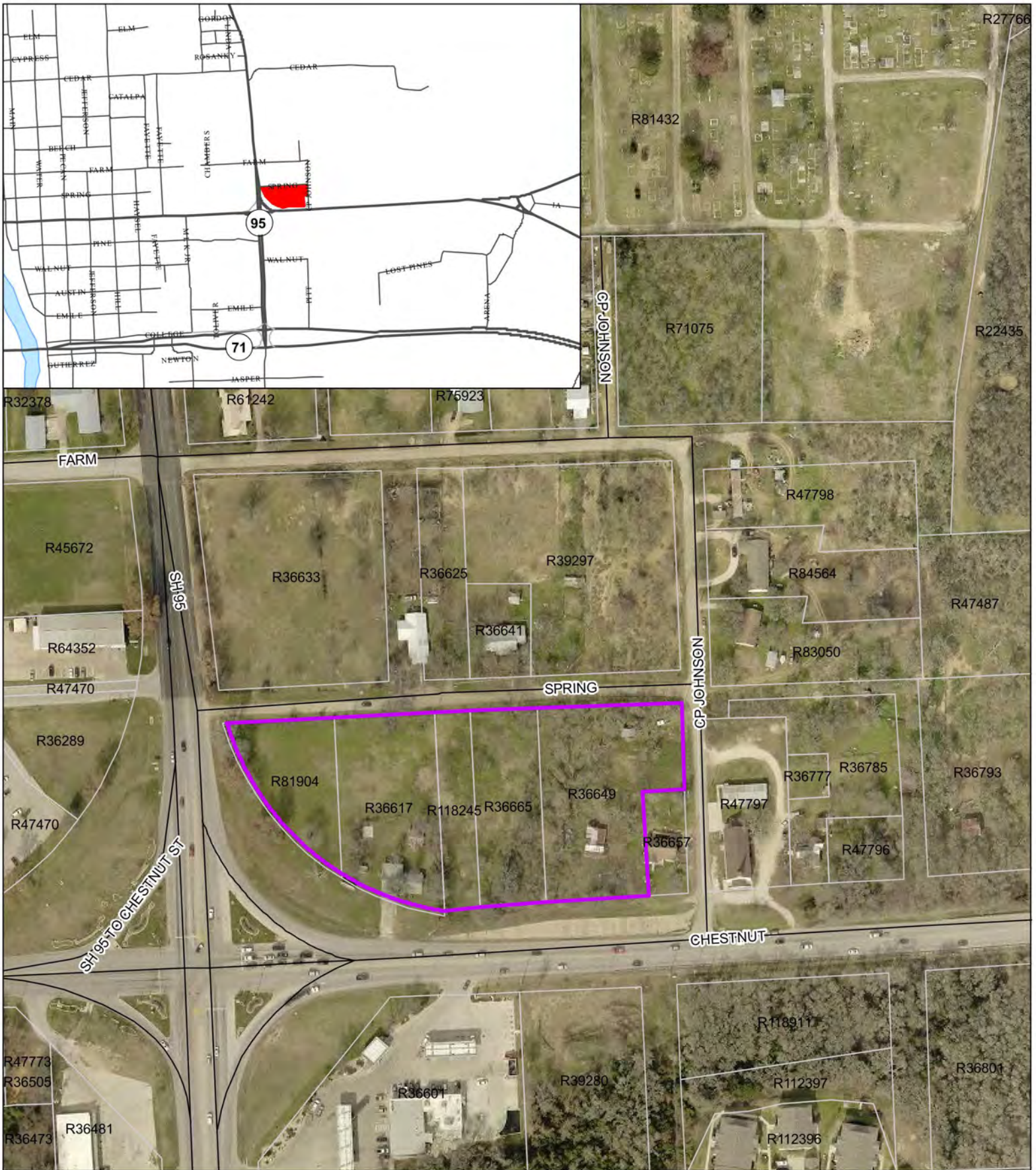

1 inch = 200 feet

**Attachment 3**  
**Aerial Location Map**  
**Zoning Map Amendment**  
**Bastrop Town Tract A11 0.398 Acres**  
**Building Block 112 E W ST 2.046 Acres**



The accuracy and precision of this cartographic data is limited and should be used for information planning purposes only. This data does not replace surveys conducted by registered Texas land surveyors nor does it constitute an "official" verification of zoning, land use classification, or other classification set forth in local, state, or federal regulatory processes. The City of Bastrop, nor any of its employees, do not make any warranty of merchantability and fitness for particular purpose, or assumes any legal liability or responsibility for the accuracy, completeness or usefulness of any such information, nor does it represent that its use would not infringe upon privately owned rights.

Date: 11/17/2017

# PLANNING & ZONING COMMISSION

## STAFF REPORT



**MEETING DATE:** June 28, 2018

**ITEM:** 4B

**TITLE:**

Discussion and update on the Draft Subdivision Ordinance.

**STAFF REPRESENTATIVE:**

Jennifer C. Bills, AICP, LEED AP, Assistant Planning Director

**BACKGROUND/HISTORY:**

The Planning Department held a series of meetings with stakeholders on June 13-14.

Wednesday, June 13 at 1:00 pm:	Utility Providers
Wednesday, June 13 at 6:00 pm:	Public Meeting
Thursday, June 14 at 9:00 am:	Developers and Homebuilders
Thursday, June 14 at 2:00 pm:	Engineers and Surveyors

Total meeting attendance was approximately 50 people.

Staff continues to take comments in hard copy and via email at [plan@cityofbastrop.org](mailto:plan@cityofbastrop.org)

From initial feedback there are several areas we would like P&Z to discuss.

1. The threshold for requiring alley. As written, any lot under 60 feet wide would require alley access. Should this threshold be less?
2. Spacing of street lights at mid-block. At a minimum, street lights at intersections and curves should be required. In the current draft, the requirement is for street lights every 200 feet for public safety and light continuity.
3. Maximum cul-de-sac length of 200 feet with a maximum of 20 lots.
4. Maximum number of homes without a second access, current draft is at 20.
5. Minimum maintenance bond requirements. There has been some pushback against the requirement for 100% for 2 years.
6. Traffic Impact Analysis, required when a development has 100 cars peak hour or 1000 Average Daily Trips. Discussion has revolved around this threshold and the effectiveness of TIAs in general.

Please bring other concerns and feedback you have received for discussion.

**ATTACHMENTS:**

Attachment 1 – Draft Subdivision Ordinance

Attachment 2 – Proposed Subdivision Ordinance Revisions Summary

Attachment 3 – Public meeting PowerPoint

## Title 10 - SUBDIVISIONS

### Chapters:

#### Chapter 10.02- IMPACT FEES (moved to end of Title and renumbered as 10.50)

#### Chapter 10.04 - GENERAL PROVISIONS AND POLICIES\*

##### 10.04.005 - Authority and jurisdiction.

- A. This chapter is adopted under the authority of the constitution and laws of the state of Texas, including particularly Subchapters A and B of Chapter 212 of the Texas Local Government Code and the City Charter of the City of Bastrop, to hereafter control the subdivision of land within the city limits of the City of Bastrop and in the unincorporated areas lying within the extraterritorial jurisdiction of the City of Bastrop, to provide for orderly development and to secure adequate provision for traffic, light, air, recreation, transportation, water, drainage, sewage and other facilities.
- B. All land subdivided or platted into lots, blocks and streets within the city of Bastrop, Texas or within its extraterritorial jurisdiction, as provided by state law, shall comply in full with the requirements of this chapter. No plat shall be filed in the office of the county clerk for a tract within the city or its extraterritorial jurisdiction unless it is approved by the City.
- C. Construction Standards Manual. The Construction Standards Manual prepared by the City's Planning Department and City Engineer is hereby adopted by reference as if set forth in full. The Construction Standards Manual shall contain specifications and policy guidance necessary to comply with the City's Subdivision and Zoning Ordinances. The Construction Standards Manual may be amended from time to time by the City Council.

##### 10.04.010 - Short title.

This chapter shall be known and may be cited as the "Subdivision Ordinance of the City of Bastrop, Texas."

##### 10.04.015 - Policy statements.

- A. It is the policy of the city of Bastrop that all subdivisions approved under this chapter shall be consistent with the comprehensive plan, zoning ordinance and any other supplemental land use and community development policies that may be adopted by the city council. No plat or subdivision of land within the city limits or its extraterritorial jurisdiction shall be approved unless it conforms to such plans, policies and ordinances.
- B. Land to be subdivided shall be of such character that it can be used safely for building purposes without danger to health or peril from fire, flood, or other menace, and land shall not be subdivided until proper provision has been made for drainage, water, sewerage, schools, transportation facilities, and other public improvements.
- C. The existing and proposed public improvements shall conform to the City's comprehensive plan and the capital budget and program of the city, and it is intended that these regulations shall supplement and facilitate the enforcement of the provisions and standards contained in building and housing codes, the zoning ordinance, comprehensive plan, and capital budget and program of the city.

##### 10.04.020 - Purpose.

It is the purpose of the subdivision ordinance of the city of Bastrop to:

- A. Provide for the orderly, safe, healthful and sustainable development of the area within the city and within the area surrounding the city in accordance with the city's comprehensive plan;



- B. Promote and protect the health, safety, and general welfare of the community by requiring that adequate streets, drainage facilities, and other public improvements are provided in all subdivisions;
- C. Provide for adequate light, air, and privacy, to secure safety from fire, flood, and other danger, and to prevent overcrowding of the land and undue congestion of population;
- D. Protect the character and the social and economic stability of all parts of the city and to encourage the orderly and beneficial development of all parts of the city;
- E. Protect and conserve the value of land throughout the city and the value of buildings and improvements upon the land, and to minimize the conflicts among the uses of land and buildings;
- F. Guide public and private policy and action to provide adequate and efficient transportation, water, sewer, drainage, schools, parks and other public requirements and facilities;
- G. Ensure that public facilities are available and will have sufficient capacity to serve the proposed subdivision;
- H. Prevent the pollution of air, streams, and ponds, to assure the adequacy of drainage facilities, to safeguard the water table, and to encourage the wise use and management of natural resources throughout the city to preserve the integrity, stability, and beauty of the community and the value of the land;
- I. Preserve the natural beauty and topography of the city and to ensure appropriate development regarding these natural features;
- J. Provide for open spaces through the most efficient design and layout of the land, including the use of average density in providing for minimum width and area of lots, while preserving the density of land as established in the zoning ordinance of the city of Bastrop;
- K. Provide facilities which can be maintained without imposing a burden to the taxpayers; and
- L. Provide accurate and complete plat records for the property within the city, all in accordance with a comprehensive plan.

10.04.025 - Interpretation and conflict.

- A. The interpretation and application of the provisions of these regulations shall be held to be the minimum requirements for the promotion of the public health, safety and general welfare.
- B. Whenever the standards and specifications in this chapter conflict with those contained in another ordinance, the most stringent or restrictive provision shall govern.

10.04.030 - Platting required.

- A. Every owner of every tract of land located within the city limits or extraterritorial jurisdiction of the city of Bastrop who divides the tract into two or more parts as provided in Chapter 212, Subchapters A and B, of the Local Government Code shall cause a plat to be made by a registered public surveyor which shall accurately describe all of the said tracts by previously platted lot and block number, or by metes and bounds if necessary and locate same as required by this chapter. It shall be unlawful for any land owner or the agent of any landowner to lay out, subdivide, plat or replat any land into lots, blocks and streets within the city limits or the City's extraterritorial jurisdiction without the approval by the City.
- B. All platted lots shall meet the minimum frontage required by the zoning ordinance onto a paved (or otherwise having an City-approved all-weather and dust free surface) street meeting the right-of-way and pavement requirements of the thoroughfare plan and this chapter.
- C. No tract or lot may be subdivided and then lots subsequently sold and no transfer of title to any part of such tract shall be made until a plat meeting the requirements of this chapter is approved by the city and filed in the plat records of Bastrop County, Texas. It shall be unlawful for any such

owner or agent to offer for sale or to sell any such property therein or thereby which has not been laid out, subdivided, platted or replatted in accordance with this Ordinance, and furnished with all the street, drainage, utility, and other improvements required by the City of Bastrop ordinances, and such improvements approved by the City Engineer or representative.

10.04.035 - Approval of plat.

- A. No plat shall be approved by the Planning and Zoning Commission unless the plat contains a dedication of land for public improvements and public purposes in accordance with the minimum requirements and standards set forth in this chapter. Every owner of property which shall hereafter be subdivided into two or more parts or platted into a single lot, shall be required to dedicate to the city that portion of such property as is necessary for the orderly development of streets, roadways, thoroughfares, utilities, emergency access, or other public purposes, and such dedication requirements, as imposed, shall be a prerequisite to plat approval.
- B. No plat shall be approved by the Planning and Zoning Commission unless it generally conforms to the comprehensive plan and adopted development policies, and unless each lot, block or tract therein fronts upon a dedicated public street, or other approved access.

10.04.040 - Dedication and improvements required—Rough proportionality—Appeals.

- A. Every owner of any tract which is required to be platted as provided in this chapter shall be required to dedicate to the city a reasonable portion of such property as is necessary for the orderly development of streets, roadways, thoroughfares, drainage, utilities, emergency access, or other public purposes, and such dedication requirements as imposed shall be a prerequisite to plat approval.
- B. The developer shall enter into an agreement with the city providing for the installation of streets, paving, curbs, gutters, street lighting, street signs, provision for underground utilities, and drainage facilities in that subdivision in accordance with the standards and provisions of the city development policies. The developer shall assure construction of the necessary improvements by posting a surety or performance bond for one hundred percent of the developer's share of construction costs, including contingencies, as approved by the city manager.
- C. Prior to a decision by the Planning and Zoning Commission on a preliminary or final plat application for which an exaction is required as a condition of approval, the City Engineer shall prepare a written statement affirming that each exaction requirement to be imposed as a condition of plat approval is roughly proportionate to the exactions required of other developments of a similar nature and extent in accordance with Texas Local Government Code Section 212.904. In making this determination, the City Engineer may consider:
  - 1. The range of facilities required, per lot, for other developments within the same zoning district or a comparable use; and
  - 2. The adequacy of existing public facilities to serve the proposed development.

The City Engineer may require that the applicant, at its expense, submit any information or studies that may assist in making the proportionality determination.

- D. An applicant for a preliminary or final plat may appeal the requirement for an exaction if the applicant believes that the exaction will result in a disproportionate burden on the applicant in comparison to other development of a like nature and extent.
  - 1. The applicant must file a written appeal with the city secretary within ten days of the date of the Planning and Zoning Commission hearing. Processing of the plat shall be suspended pending resolution of the appeal and no developer's agreement may be executed until the appeal is resolved.
  - 2. The city secretary shall schedule a hearing of the appeal before the city council at a regularly scheduled city council meeting within thirty days following receipt of the written appeal. One week prior to the scheduled city council meeting, the applicant shall submit fifteen copies of a study prepared by a registered professional engineer demonstrating that the exaction being

required is not roughly proportionate to those required of other development of a similar nature and extent within the city of Bastrop. Such study shall also demonstrate that a waiver or modification of the required exaction shall not result in inadequate public facilities to serve the proposed development. The City Engineer shall also submit their findings regarding the need for the required exactions and the basis for their rough proportionality determination.

3. After holding the hearing and receiving evidence on both sides, the city council may:
  - a. Deny the appeal and impose the exaction requirement of the Planning and Zoning Commission;
  - b. Grant the appeal and waive in whole or in part an exaction requirement necessary to achieve proportionality; or
  - c. Grant the appeal and direct that the city shall participate in the costs of the exaction.

The city council shall make such determination within thirty days of the hearing.

4. An applicant may appeal the determination of the city council to a county or district court of Bastrop County within thirty days of the final determination by the city council.

#### E. Waivers and Exceptions

When a subdivider can show that a provision of these regulations would cause unnecessary hardship if strictly adhered to, and where, because of some condition peculiar to the site, and when in the opinion of the Planning and Zoning Commission, a departure may be made without destroying the intent of such provisions, the Commission may authorize a waiver or exception to these regulations.

#### 10.04.050 - Construction—Building permits—Certificates of occupancy.

- A. The city shall recommend against approval of a septic tank permit by Bastrop County for the installation of septic tanks upon any lot in a subdivision or upon any tract of land for which a final plat has not been approved and filed for record, or is not on a "lot of record" as defined by this Ordinance, or upon any lot in a subdivision in which the standards contained in this chapter or referred to in this chapter have not been complied with in full.
- B. No building, repair, plumbing, mechanical, or electrical permit shall be issued by the city for any structure on a lot in a subdivision or upon any tract of land for which a final plat has not been approved and filed for record, nor for any structure on a lot within a subdivision in which the standards contained in this chapter or referred to in this chapter have not been complied with in full. This provision shall not apply to any building permit that does not add more than four hundred square feet (400 SF) or twenty percent (20%) of the existing building footprint, cumulative for the last five (5) years, fence permits, sign permits, or building permits for flatwork (e.g. driveways) for lots of record as of April 20, 1981.
- C. No application for a building permit shall be considered for approval by any city official until the developer has entered into an agreement providing for the installation of water, sewer, streets, paving, curbs, gutters, utilities, and drainage facilities in that subdivision and completed those facilities in accordance with such provisions and standards of the city. Assurances of such installation within a set time limit will be provided by the making of cash or corporate surety bond or depositing money in escrow as provided by city development policies.
- D. The city shall not repair, maintain, install or provide any streets or public utility services in any subdivision for which a final plat has not been approved and filed for record, nor in which the standards contained in this chapter or referred to in this chapter have not been complied with in full.
- E. The city shall not permit the sale or supply of any water, gas, electricity, or sewerage service to a lot within a subdivision or to any tract of land for which a final plat has not been approved and filed for record, nor in which the standards contained in this chapter or referred to in this chapter have not been complied in full. Nothing contained in this chapter shall be construed to prohibit

maintenance of existing service except where, in the determination of the Director of Planning and building official, a public health and safety hazard exists.

- F. Any land which, in its natural state, is subject to a one hundred-year flood or which cannot be properly drained shall not be subdivided, resubdivided, or developed until it is demonstrated to the satisfaction of the City Engineer that the construction of specific improvements proposed by the developer can be expected to yield a usable building site.
- G. No building permit or certificate of occupancy approval shall be granted for any building occupied by a single business or residence that crosses a lot or property line, until the property is replatted into a single lot.
- H. No construction of any public improvements shall be initiated by the developer/owner until, (1) a final plat has been approved by the city; (2) a developer's agreement has been approved by the city; (3) all performance, payment and maintenance bonds, or their equivalent, have been provided to the city; (4) all inspection and permit fees have been paid; and (5) a notice to proceed is issued by the city.

## **10.08 CERTAIN DEDICATIONS AND RESERVATIONS (INCLUDING PARK LAND, TRAILS AND SCHOOLS)**

### 10.08.010 - Designation on Plat

The specific use for which each piece of land is to be reserved or dedicated for the public must be shown by appropriate label or description on the subdivision plat. Provision for future abandonment of a reservation as may be appropriate must be likewise be shown on said plat.

### 10.08.020 - Park Land Dedication

#### A. Purpose.

- 1. This section is adopted to provide recreational areas in accordance with the park and recreation facilities element of the Bastrop comprehensive plan in the form of neighborhood parks as a function of development in the city of Bastrop. It is declared by the city council that recreational areas in the form of neighborhood parks are necessary and in the public welfare, and that the only adequate procedure to provide the same is by integrating such a requirement into the procedure for planning and developing property for subdivisions in the city.
- 2. Neighborhood parks are those parks providing for a variety of outdoor recreational opportunities and within convenient distances from most of the residences to be served thereby. The park areas established by the city council and shown on master plan for the city shall be prima facie proof that any park located therein is within such a convenient distance from any residence located therein. The primary cost of neighborhood parks should be borne by the ultimate residential property owners who, by reason of the proximity of their property to such parks, shall be the primary beneficiaries of such facilities. Therefore, the following requirements are adopted to achieve the purposes stated.

#### B. General

- 1. Within City or area pending annexation: Whenever a final plat is recorded with the County Clerk of Bastrop County for development of a residential area in accordance with the planning and zoning ordinances of the city, within the City of Bastrop or an area outside the city that will be requesting annexation, the plat shall contain a clear fee simple dedication of an area of land to the City for park purposes. Fee simple title to the parkland shall be conveyed to the city by general warranty deed. The proposed park and its location must be approved by City Council during the preliminary plat stage. This area shall equal one (1) acre for each one hundred (100) proposed dwelling units, or five (5) percent of the total residential platted area (excluding streets), whichever is greater. As far as practical, all dedications of

land shall be in a single parcel. Any proposed plat submitted to the City for approval shall show the area proposed to be dedicated under this section. Upon the approval of the City Council, the dedication required by this section may be met by the payment of money instead of land when permitted or required by the provisions of this section, or by a combination of both.

2. Within the Statutory ETJ with no pending annexation:
  - a. General: All subdivisions developed under these provisions shall be required to establish a Homeowners Association or similar entity to own and maintain entry features, parks, trails, landscaping and appurtenances.
  - b. Subdivisions developed under these provisions shall include park and trail amenities within the subdivision. Where a subdivision [is] developed under these provisions either as one section of a multi-section development, or part of a larger development with mixed use development, the parks, trails and other amenities may be located in other sections other than the specific section developed under these provisions.
  - c. Minimum Park Requirement: At a minimum, park facilities providing one acre for every 100 lots shall be provided.
3. The City reserves the right to require either parkland dedication or a cash payment to a special park fund in lieu of dedication for all submitted plats. If the City determines that sufficient park area is already in the public domain around the proposed development, or if the parkland recreational needs of the area would be better served by expanding or improving existing parks, the City will require payment of money in lieu of dedication of parkland.
4. The City declares that in most cases the development of an area smaller than three (3) acres for public park purposes as impractical. Therefore, if fewer than three hundred (300) units are proposed by a plat filed for approval resulting in a dedication of less than three (3) acres, the developer shall be required to pay the applicable cash payment required by Section 10.08.010.C.2 of this Ordinance instead of dedicating land. However, in instances where land can be dedicated in an area adjoining an existing park or school playground, the City reserves the right to require the dedication of land in such area.

In instances where an area of more than two acres are required to be dedicated, the city council shall have the right to accept the dedication for approval on the final plat, or to refuse same, after consideration of the recommendation of the park and recreation board and Planning and Zoning Commission, and to require payment of cash in lieu of land, if the city determines that sufficient park area is already in the public domain in the area of the proposed development, or if the recreation potential for that zone would be better served by expanding or improving parks.
5. The dedication required by this section shall be made by the filing of the final plat clearly showing such parkland dedication, along with a warranty deed in fee simple. If the actual number of completed dwelling units exceeds the figure upon which the original dedication is based, such additional dedication shall be required, and shall be made by payment of cash instead of the land amount provided in subsection 10.08.010.C.2.
6. Whenever payment of money instead of park dedication is determined to be appropriate, the location of the park where the funds will be spent shall be determined within two (2) years of the final acceptance of the completed subdivision. If the funds will be used to acquire land for a park, the general location where the park is being proposed must be identified within three (3) years of the final acceptance of the completed subdivision. The location of the park will be in an area reasonably anticipated to serve the subdivision.

C. Money In Lieu of Dedication of Land

1. If permitted by the city council, an owner responsible for park land dedication may satisfy the requirements of Section 10.08.010.B.1. in whole or in part by cash payment instead of dedication of land in the amount set forth in Section 10.08.010.C.2 hereunder. Payments, instead of land, shall be made at the time of final plat approval by the City.
2. The dedication requirement shall be met by a cash payment at a per dwelling unit price sufficient to acquire land for a neighborhood park to serve the area in which such development is located, or to expand an existing park to serve the development. Unless specified otherwise by the Council due to recent land sales around the proposed plat (to include the proposed platted area), such per unit price shall be computed based on the amounts in the Code of Ordinances, Appendix A, Section A10.03.002. This amount will be reviewed periodically and will be adjusted to accurately reflect what land is selling for per acre in the City's growth areas. Cash payment may be used only for acquisition, maintenance or improvements of parks, which will serve the development. The City will determine where and how the money will be spent within two (2) years if funds will be spent on park improvements or three (3) years if funds are to be used to acquire parkland, from the date of final acceptance of the completed subdivision. The finance department will keep a detailed record of such funds, which will be reviewed annually with the city budget.

D. Comprehensive Plan Considerations. The Parks and Recreation section of the Comprehensive Plan should be consulted to determine what park service area a proposed subdivision is part of and the need for parkland or park facilities and equipment in that service area. Land shown on the city's comprehensive plan as being suitable for development by the city for a major recreational center, school site, park, or other public use, shall be reserved for a period of one year after the preliminary plat is approved by the city. A failure by the city council to notify the subdivider of its interest in acquiring the land within the one-year period shall constitute a waiver of the right to reserve the land. Any waiver of the right to reserve the land shall no longer be effective if the preliminary plat expires without adoption of a final plat.

E. Special Park Fund

1. There is hereby established a special fund for the deposit of all sums paid in lieu of land dedication under this section, which fund shall be known as the "Parkland Dedication Fund". All monies set aside in said Parkland Dedication Fund shall be used exclusively for parkland acquisition and recreation improvements in new or existing parks within the area of the subdivision which contributes the money, or as close to the subdivision as practical to ensure that the subdivision's residents gain the benefit of the improvements.
2. The City shall account for all sums paid instead of land dedication under this ordinance with reference to the individual plats involved and the contributing developer. Any funds paid for such purposes must be expended by the City within five (5) years from the date received by the City for acquisition or development of a neighborhood park. However, if the funds paid for parkland dedication are being accumulated to acquire and develop a larger neighborhood park (a park more than five (5) acres or more which will provide multiple recreational facilities and will serve several adjacent subdivisions) the funds must be expended within seven (7) years from the date received by the City. When funds from several different subdivisions are being accumulated to develop a larger neighborhood park serving several different subdivisions, they shall be segregated in an account earmarked for that project within the Parkland Dedication Fund. Such funds shall be spent on a first in, first out basis. If not so expended on or before the last day of such period, the contributing developer may ask for a pro rata refund computed on a contributing housing unit basis. If the developer does not ask for a refund within three hundred sixty-five (365) days after the five (5) or seven (7) year expenditure period ends, (as applicable) such right to refund shall be barred.

3. Placing the Parkland Dedication Fund in a "treasury fund" established by the City, so long as accounting procedures established maintain a separate account for these proceeds for the purposes set forth herein and assure that funds will not be disbursed for any purposes not set forth in this ordinance, shall not be considered a violation of this section.

F. Additional Requirements

1. Any land dedicated to the City under this section must be suitable for recreational purposes, such as parks, playgrounds and usable open space. The following characteristics of proposed area are generally unsuitable (unless recommended in the comprehensive plan):
    - a. Any area primarily located in the one hundred year-(100-yr) floodplain.
    - b. Drainage areas may be accepted as a part of a neighborhood park if the entire floodplain width is dedicated to the city and if no significant area of the park is cut off from access by such channel. Land that is included in the FEMA-designated floodway shall not count toward meeting the required parkland dedication. If land is dedicated which is in the floodway fringe but not including the floodway, then it shall count as one-half ( $\frac{1}{2}$ ) of the requirement as set forth in Section 10.08.010.B.1. Required detention ponds may be counted as required parkland if designed to accommodate recreational activities.
    - c. Any areas of unusable topography or slope which render more than twenty-five percent (25%) of the area unusable for organized recreational activities, or due to unusual circumstances relating to subsoil, slope or topography, the development of the property for park or recreational purposes would be unusually difficult or expensive as determined by the director of public works.
    - d. The above characteristics of a parkland dedication area may be grounds for refusal of any preliminary or final plat.
    - e. City Council may alter or waive the above requirements, concerning floodplain dedication, if it is determined that such floodplain area will be beneficial to the City.
  2. Each park must have ready access to an improved public street to provide visual access to a majority of the park area. Furthermore, the land dedicated for parkland must have at least two hundred feet (200') of frontage on a street.
  3. The developer shall perform, at a minimum, a Phase I Environmental Assessment of the tract of land proposed to be dedicated to the City for a park. At the City's request, the developer shall also perform a Phase II Environmental Investigation of such land. If, in the sole judgment of the City, the land is environmentally unsuitable for use as parkland, the City shall reject the dedication and shall require the developer to either dedicate alternate acceptable land, or to pay cash in lieu of dedicating land. Environmental Assessments shall comply with American Society for Testing and Materials (ASTM) standards.
  4. Any costs associated with land that is to be dedicated for parkland such as surveying, title transfer, environmental assessments or mitigation must be paid by the developer.
  5. Unless provided otherwise in this chapter, an action by the city shall be by the city's Planning and Zoning Commission.
  6. All parkland dedication shall be consistent with the standards as set forth in the comprehensive plan.
- G. Credit for Private Parks. If a developer desires to incorporate private park, recreation or open space areas or amenities within their development, they may request limited credit for these facilities against their public open space requirements. A developer may request credit for any private park, recreation or open space area, but such private park, recreation or open space amenities may never satisfy more than fifty percent (50%) of the total park and open space dedication requirement of this chapter.
- H. Appeals. Decisions of the Director of Planning in the implementation of this policy may be appealed to the Board of Appeals. The standard for review of decisions shall be whether the

decision rendered was clearly unreasonable, arbitrary or capricious and therefore constituted a clear abuse of discretion.

#### 10.08.020 - Greenways/Trail System (Linear Parks)

##### A. General.

1. Whenever a final plat is recorded with the County Clerk of Bastrop County for any development (residential or nonresidential), within the City of Bastrop or an area outside the city that will be requesting annexation, the plat shall contain a clear fee simple dedication of an area of land to the City for a greenway in those areas proposed for a trail system within the Comprehensive Plan or in other areas proposed by the City.
2. The area dedicated for the greenway must run through the entire subdivision or adjoin the entire subdivision and be twenty (20) feet in width. In addition, a setback of at least fifteen (15) feet must be established on either side of the trail dedication.
3. The dedication provided must be such that it will connect with any existing trail or any proposed trail provided for within the Comprehensive Plan.
4. The developer will not be required to build a trail within the greenway, rather a cash payment equivalent to the cost to build a four-foot (4') sidewalk within the dedicated area must be provided to the city, which will build the trail system. Unless specified otherwise by Council, such per unit price shall be computed based on Code of Ordinances, Appendix A, Section A10.03.002. Such payments shall be made prior to the time the subdivision improvements are accepted.
5. In some cases, a subdivision will not contain a proposed trail as set forth in the Comprehensive Plan or required by the City. In those cases, the developer must provide cash in lieu of greenway dedication. Unless specified otherwise by the Council, such cash payment shall be computed based on the Code of Ordinances, Appendix A, Section A10.03.002. These funds will be used to construct a trail and/or provide landscaping and other amenities for the trail system closest to the subdivision to ensure that the subdivision residents gain the benefit of the improvements. Such payments shall be made prior to the time the subdivision improvements are accepted.
6. The City reserves the right to require either land dedication or a cash payment in lieu of trail dedication for all submitted plats.
7. All subdivisions in the ETJ and not pending annexation shall provide for the continuity of trail systems in existence, or addressed in the City's Comprehensive Plan, regardless of size. Subdivisions of more than fifty acres (in total size) shall provide a plan for a trail system internal to the subdivision. All facilities shall conform to ADA Standards.

##### B. Special Trail System Fund.

1. There is hereby established a special fund for the deposit of all sums paid for trail system construction, which fund shall be known as the "Trail System Fund". All monies set aside in said Trail System Fund shall be used exclusively for the acquisition and construction of a trail system and the landscaping of such trail.
2. The City shall account for all sums for trail system construction under this ordinance with reference to the individual plats involved and the contributing developer. Any funds paid for such purposes must be expended by the City within five (5) years from the date received by the City. Such funds shall be spent on a first in, first out basis. If not so expended, the contributing developer(s) on the last day of such period shall ask for a refund computed on a per acre basis. If the developer does not ask for a refund within three hundred sixty-five (365) days after the expenditure period ends, as provided above, such right to refund shall be barred.
3. Placing the Trail System Fund in a "treasury fund" established by the City, so long as accounting procedures established maintain a separate account for these proceeds for the



purposes set forth herein and assure that funds will not be disbursed for any purposes not set forth in this ordinance, shall not be considered a violation of this section.

#### 10.08.030 - Schools

The location and size of proposed school property shall be in accordance with the requirements of the Bastrop Independent School District.

#### 10.04.040 - Acceptance of dedication.

Any dedication of streets, utilities, easements, public areas, parks or other land shown on a plat shall be deemed to be an offer of dedication which may be withdrawn by the subdivider/owner at any time prior to filing of the plat in the deed records. Withdrawal of any such dedication shall void any previous approval of the plat. Approval of a plat by the Planning and Zoning Commission shall not be deemed an acceptance of any proposed dedication and shall not impose any duty on the city concerning the improvements or maintenance of such dedication until the developer has improved same and the city has accepted and made use thereof.

- A. For any subdivision for which a plat has been filed for record, or where land has been divided by metes and bounds and no plat filed for record, and which has not been approved according to these regulations, or which fails to meet the standards contained or referred to in this chapter, the commission shall adopt a resolution concerning such failures or lack of approval and indicating that same is in violation of the provisions of this chapter. The commission shall cause a copy of such resolution, signed by the chairman of the commission and attested to and notarized by the city secretary or designee, to be filed in the Deed Records of Bastrop County.
- B. If compliance and approval are secured following the filing of such resolution, the commission shall file in the Deed Records of Bastrop County an instrument that, in effect, rescinds such earlier filed resolution.
- C. Disapproval of a plat by the commission shall be deemed a refusal by the city to accept the offered dedications shown thereon. Approval of a plat shall not impose any duty upon the city concerning the maintenance or improvement of any such dedicated parts until the proper authorities of the city have appropriated the same by entry, use, or improvement. Any such dedication, before or after actual appropriation may be vacated by the council in any manner provided by law.

### **Chapter 10.10 - DEFINITIONS**

#### 10.10.005 - Usage.

The following words and phrases when used in these rules, regulations and procedures have the meaning respectively ascribed to them in this section, unless a different meaning is plainly required by the context clearly indicates to the contrary, words used in the present tense include the future tense; words used in the plural number include the singular; the word "herein" means "in these rules, regulations and procedures." A "person" includes a corporation, a partnership, and an incorporated association of persons such as a club; a "building" includes a "structure"; a "building" or "structure" include any part thereof; "used" or "occupied" as applied to any land or building shall be construed to include the words "intended, arranged, or designated to used or occupied." Any office referred to in these rules, regulations and procedures by title means the person employed or appointed by the city in the position, or their duly authorized representative. Definitions not expressly prescribed in this chapter are to be construed in accordance with customary usage in municipal planning and engineering practices.

#### 10.10.010 - Definitions.

As used in this chapter:

*Access, Adequate.* "Adequate access" means having frontage on a paved road meeting the right-of-way and pavement dimensions set forth in the official thoroughfare plan.

*Access controller* means the facility controlling vehicular access to private street developments that may be a mechanism or a manned structure.

*Access Easement* means an easement across a lot, or lots, providing vehicular access to adjoining lots and/or a public street. Access easements shall include emergency access and fire lanes when such access is required.

*Acreage, Gross.* "Gross acreage" means the total acreage of a subdivision, including areas dedicated to the public use such as street and alley rights-of-way.

*Acreage, Net.* "Net acreage" means the total acreage of a subdivision less those areas dedicated to public use such as street and alley rights-of-way. Easements, however, shall be included in net acreage calculations.

*Administrative officers* means any office holder referred to in this chapter by title, i.e., mayor, City Attorney, city secretary, City Engineer, Director of Planning, etc., shall be the person so retained in this position by the city, or their duly authorized representative.

*Administrative Procedure* shall mean the procedure to be followed for the approval of the subdivision or re-subdivision of an existing lot(s) when such subdivision meets certain limited conditions set by the City.

*Alley* means a minor public right-of-way, not intended to provide the primary means of access to abutting lots, which is primarily for vehicular service access to the back or sides of lots or properties otherwise abutting on a street.

*Amending Plat* shall mean a plat as defined in § 212.016 of the Texas Local Government Code and the procedure for such plats shall be the same as the Short Form procedure as defined herein if the amending plat is signed by the applicants only and is solely for one or more of the following purposes:

1. to correct an error in a course or distance shown on the preceding plat;
2. to add a course or distance that was omitted on the preceding plat;
3. to correct an error in a real property description shown on the preceding plat;
4. to indicate monuments set after the death, disability, or retirement from practice of the engineer or surveyor responsible for setting monuments;
5. to show the location or character of a monument that has been changed in location or character or that is shown incorrectly as to location or character on the preceding plat;
6. to correct any other type of scrivener or clerical error or omission previously approved by the City, including lot numbers, acreage, street names, and identification of adjacent recorded plats;
7. to correct an error in courses and distances of lot lines between two adjacent lots if:
  - a. both lot owners join in the application for amending the plat;
  - b. neither lot is abolished;
  - c. the amendment does not attempt to remove recorded covenants or restrictions; and
  - d. the amendment does not have a material adverse effect on the property rights of the other owners in the plat;
8. to relocate a lot line to eliminate an inadvertent encroachment of a building or other improvement on a lot line or easement;
9. to relocate one or more lot lines between one or more adjacent lots if:
  - a. the owners of all those lots join in the application for amending the plat;
  - b. the amendment does not attempt to remove recorded covenants or restrictions; and
  - c. the amendment does not increase the number of lots;
10. to make necessary changes to the preceding plat to create six or fewer lots in the subdivision or a part of the subdivision covered by the preceding plat if:
  - a. the changes do not affect applicable zoning and other regulations of the municipality;
  - b. the changes do not attempt to amend or remove any covenants or restrictions; and
  - c. the area covered by the changes is in an area that the municipal planning commission or other appropriate governing body of the municipality has approved, after a public hearing, as a residential improvement area; or

11. to replat one or more lots fronting on an existing street if:
  - a. the owners of all those lots join in the application for amending the plat;
  - b. the amendment does not attempt to remove recorded covenants or restrictions;
  - c. the amendment does not increase the number of lots; and
  - d. the amendment does not create or require the creation of a new street or make necessary the extension of municipal facilities.

*Applicant* means the owner of land proposed to be subdivided, or their representative when written consent is obtained from the legal owner of the premises. The terms "applicant," developer," and "subdivider" are used interchangeably in these rules, regulations and procedures.

*Arterial*. See Street, Arterial.

*Authorized agent* means a person empowered by another by notarized statement or power of attorney to represent, act for and transact business with the city.

*Benchmark, Elevation*. A permanent benchmark that identifies the vertical elevation above mean sea level or other approved level.

*Block* means an area enclosed by streets and occupied by or intended for buildings; or if such word is used as a term for measurement, it shall mean the distance along a side of a street between the nearest two streets which intersect such street on the said side. When necessary, the Director of Planning shall determine the outline of the block in cases where platting is incomplete or disconnected.

*Bond* means any form of security including a cash deposit, surety bond, collateral, property, or instrument of credit in an amount and form satisfactory to the city. All bonds shall be approved by the City Attorney wherever a bond is required by the subdivision ordinance or these rules, regulations and procedures.

*Building* means any structure built for the support, shelter, and/or enclosure of persons, animals, chattels or moveable property of any kind. When subdivided in a manner sufficient to prevent the spread of fire, each portion so subdivided may be deemed a separate building.

*Building setback line* means a line parallel or approximately parallel to the street right-of-way line at a specific distance therefrom marking the minimum distance from the street right-of-way line that a building may be erected.

"Building site" means land occupied or to be occupied by a building and its accessory building and including such open spaces as are required under this chapter and having direct access to a public street.

*Caliper* means the diameter of a trunk measured one foot above ground level. This method of measurement is used for trees that are planted as a requirement of the Zoning and Subdivision Ordinances.

*Capital improvements* means facilities of a permanent nature, such as streets, drainage, sanitary sewer, etc.

*Channel sinuosity* equals the length between two points on the channel thalweg divided by the straight-line distance.

*City or The City* shall mean the City of Bastrop, Texas.

*City council* means the city council of the city of Bastrop, Texas.

*City Engineer* shall mean a registered Engineer or their representative employed by the City and shall not be employed by the developer/subdivider without prior approval of the City Council. "City Engineer." The person designated by the city manager to review engineering aspects of projects located within the city.

*City inspector* means the person designated by the city manager to provide inspection services for public improvements or buildings.

*City manager* means the person duly approved by the city council and charged with the responsibility of administering the city's various departments.

*City Secretary* shall mean the City Secretary of the City of Bastrop or the authorized representative of the secretary.

*Collector Street*. See Street, Collector.

*Commission* means the Planning and Zoning Commission of the city.

*Common area* means an area or facility that is owned jointly by the owners within the subdivision and/or members of the property-owners association. Common areas include, but are not limited to, private parks, community buildings and screening walls.

*Comprehensive plan* means the comprehensive plan of the city of Bastrop, Texas, as adopted by the city council of the city of Bastrop, Texas.

*Construction plans* means the maps or construction drawings accompanying a subdivision plat that show the specific location and design of all required or proposed improvements to be installed in the subdivision.

*Covenant* means an agreement to do or refrain from doing certain acts.

*Crosswalk* means a public right-of-way, four feet or more in width between property lines, which provides pedestrian circulation.

*Cul-de-sac* means a street having but one outlet to another street and terminated on the opposite end by a vehicular turnaround.

*DBH* or "dbh" means diameter at breast height; the average diameter (outside the bark) of a tree four and one-half above mean ground level. This method of measurement is used to measure existing trees.

*Dead-end street* means a street, other than a cul-de-sac, with only one outlet.

*Dedication* means a gift or donation of property or interest in property by the owner to the public.

*Density* means the number of dwelling units per gross acre of subdivision, excluding any areas that are nonresidential in use.

*Detention pond* means a pond or impoundment designed to store stormwater runoff for controlled release during or immediately following the storm event.

*Developer* means an individual, partnership, corporation, or governmental entity undertaking the subdivision or improvement of land and other activities covered by the subdivision ordinance or the design standards and criteria, including the preparation of a subdivision plat showing the layout of the land and the public improvements involved therein. The term "developer" is intended to include the term "subdivider" even though personnel in successive stages of a project may vary.

*Developer's agreement* means a written contractual agreement between the city and the developer establishing the terms and conditions for approval and acceptance of the public improvements required for a development.

*Drainage plan* means an engineering study evaluating stormwater runoff and flows that recommends drainage improvements necessary to comply with design standards adopted by the city.

*Dwelling* means any building or portion thereof, which is designed for or used for residential purposes.

*Easement* means an interest in land granted to the city, to the public generally, and/or to a private or public utility corporation for installing and/or maintaining public facilities or utilities.

*Easement, Access*. "Access easement" means an easement created for providing vehicular or pedestrian access to a property.

*Easement, Drainage.* "Drainage easement" means an easement created for conveying stormwater across property either on the surface or in an underground system. A drainage easement entitles the city to make necessary improvements within the easement to adequately convey stormwater.

*Emergency* means a response by the appropriate city department to an alarm or call requiring immediate action in the interest of the public health and safety.

*Engineer* means a person duly authorized under the provisions of the Texas Engineering Registration Act, as heretofore or hereafter amended, to practice the profession of engineering.

*Erosion control* means structural and nonstructural techniques to prevent the erosion and sedimentation of soil from rainfall and/or runoff.

*Extraterritorial Jurisdiction (ETJ)* shall mean that area adjacent to the city limits of the City over which the City is authorized to control, among other things, subdivision as prescribed or defined by law.

*Exaction* means a requirement imposed as a condition for approval of a plat, preliminary plat, building permit, planned development district or other development permit application to:

1. Dedicate an interest in land for a public infrastructure improvement;
2. Construct a public infrastructure improvement; or
3. Pay a fee in lieu of constructing a public infrastructure improvement.

*Final plat* means the one official and authentic map of any given subdivision of land prepared from actual field measurement and staking of all identifiable points by a surveyor with the subdivision location references to a survey corner or other established reference and all boundaries, corners and curves of the land division sufficiently described so that they can be reproduced without additional references. Angular measurements and bearings shall be accurate to the nearest tenth of a foot. The final plat of any lot, tract, or parcel of land shall be recorded in the Plat Records of Bastrop County, Texas.

*Floodplain* means an area identified by the Federal Emergency Management Agency as possibly being flood-prone at or below the base flood elevation (one hundred-year floodplain, or one-percent probability flood event). The issuance of building permits for construction of any structure within such floodplain is regulated by a separate specific ordinance governing the safeguards, preventing actions against flooding, types of uses permitted in flood-prone areas, etc.

*Floodway* means the channel of a river of other water course and the adjacent land areas that must be reserved to discharge the base flood as defined by the Federal Emergency Management Agency without cumulatively increasing the water surface elevation more than one foot.

*Floodway fringe* means the area within the floodplain but outside of the floodway.

*Geotechnical testing* means testing by a qualified professional testing laboratory to determine the engineering characteristics of soil, rock and/or fill material.

*Government employees in pursuit of their official duties* means a government employee, such as, but not necessarily limited to, police, fire, code enforcement, public works, City Engineer, planning, building inspections, and other local, county, state, and/or federal employees; i.e., postal workers, school districts (e.g., school buses), and/or their designee/contractor in the process of addressing functions and activities that relate to the public health, welfare and safety.

*Greenbelt* means an open space area consisting of primarily natural features, that may be in a floodplain or along a creek channel or be used as a buffer between land uses or be used as an open space linkage between various land uses.

*Hike and bike trail* means a hike and bike trail has a minimum ten-foot concrete surface width and is a trail which serves as a linkage for residential access to recreational and educational areas and facilities.

*Homeowners Association* shall mean an incorporated or unincorporated association that is designated as the representative of the owners of the property in the Suburban Subdivision that: (1) has a membership primarily consisting of the owners of the property covered by the dedicatory instrument for the Suburban Subdivision, and (2) manages and/or regulates the Suburban Subdivision for the benefit of the owners of property in the subdivision.

*Illegal lot* means any tract of land whose boundaries have been altered without an approved subdivision plat since April 20, 1981.

*Infrastructure* means facilities needed to sustain manufacturing, residential, commercial and all other land use activities. Infrastructure includes water lines, sewer lines, and other utilities, streets and roads, communications, and public facilities, such as fire stations, parks, schools, and other similar type uses.

*iSWM™* means the Integrated Storm Water Management Design Manual™ as published by the North Central Texas Council of Governments and as modified and adopted by the city of Bastrop.

*Land use plan* means part of comprehensive plan showing future land use.

*Landscape plan* means a plan showing the proposed landscape improvements to be made on a site.

*Legal Lot of Record* means any unplatted tract of land whose boundaries have not been changed since April 20, 1981.

*Lot* means an undivided tract or parcel of land having frontage on a public street, or upon an approved open space, having direct street access, and which is, or in the future may be, offered for sale, conveyance, transfer or improvement; which is designated as a distinct and separate tract, and which is identified by a tract or lot number in a duly-approved subdivision plat which has been properly approved by the city and filed on record with the county clerk.

1. *Area, Lot.* "Lot area" means the area of the lot shall be the net area of the lot and shall not include portions of streets and alleys.
2. *Lot depth* means the distance between midpoints of straight lines connecting the foremost points of the side lot line in front and the rearmost points of the side lot lines in the rear (the mean horizontal distance between the front and rear lot line.)
3. *Lot, Double Frontage or Through.* "Double frontage lot" or "through lot" means a lot, other than a corner lot, with frontage on more than one street.
4. *Lot, Frontage.* "Frontage lot" means the length of street frontage between property lines.
5. *Lot, Irregular.* "Irregular lot" means any lot not having equal front or rear lot lines, or equal side lot lines; a lot, the opposite lot lines of which vary in dimension and the corners of which have an angle of either more or less than ninety degrees.
6. *Lot orientation* means the compass reading for a line drawn from a point midway-between the side lot lines at the required front yard setback to a point midway between the side lot lines at the required rear yard setback.
7. *Lot width* means the distance between straight lines connecting front and rear lot lines at each side of the lot, measured across the rear of the required front yard, provided, however, that the width between side lot lines at their foremost points (where they intersect with the street line) shall not be less than eighty percent of the required lot width except in the case of lots on the turning circle of cul-de-sacs, where the eighty percent requirement shall not apply.

*Master Plan.* The phrase "Master Plan" shall be the comprehensive plan of the city and adjoining areas as adopted by the city council and the Planning and Zoning Commission, including all its revisions. This plan indicates the general location recommended for various land uses, transportation routes, public and private buildings, streets, parks, water, sewer, and other public and private developments and improvements.

*Neighborhood Park.* See Park, Neighborhood.

*Notice to proceed* means a written authorization permitting the developer to proceed with construction of the approved public facilities.

*On-Site Sewer Facilities (OSSF)* shall mean on-site wastewater disposal systems and facilities, commonly referred to as septic systems, whether of a traditional or "engineered" design.

*Open Space, Private.* Within a subdivision, "private open space" means private property under common ownership designated for recreational area, private park (for use of property owners within the subdivision), play lot area, plaza area, building setbacks (other than those normally required), and ornamental areas open to the general view within the subdivision. Private open space does not include streets, alleys, utility easements, public parks or required setbacks. Private open space within a specific lot is the area included in any side, rear or front yard or any unoccupied space on the lot that is left open and unobstructed to the sky except for the ordinary projections or cornices, eaves or porches.

*Open Space, Public.* Within a subdivision, "public open space" means property which has been designated for park land, recreation, or wildlife conservation areas which have been dedicated to, and accepted by, the city of Bastrop or other federal, state, or municipal governmental entity.

*Owner of record* means legal owner or owners of the land.

*Park* means land dedicated to, or purchased by, the city or other federal, state, or municipal governmental entity for providing public recreation or open space areas.

*Park, City* means any public park, playground, recreation or open space area together with parking lots, which is operated, maintained and controlled by the City, and heretofore platted, dedicated, or designated as a public park within the City.

*Park, Neighborhood.* "Neighborhood park" means a public park intended to serve the recreation needs of people living or working within a one-half mile radius of the park.

*Park, Private.* "Private park" means a tract of land presently owned or controlled and used by private or semi-public persons, entities or groups for active or passive recreational purposes.

*Party-in-interest* means an authorized agent of the owner of record.

*Pavement width* means the portion of a street available for vehicular traffic; where curbs are laid, it is the portion from the face of a standard seven-inch curb to the face of the opposite curb.

*Person* means any individual, association, firm, corporation, governmental agency or political subdivision.

*Petition* means a written request.

*Phased development* means a plat presented by the developer that proposes that only part of the tract is to be developed; the remainder of the tract to be developed later.

*Planned development* means a subdivision that consists of a variety of land use types, incorporating a single or variety of types of residential dwelling units, public open spaces, and common open space and recreational areas, adequate to service the needs of the tract when fully developed and populated, which is to be developed as a single entity, under unified control. In tracts within a single zoning district, the planned development suffix allows for flexibility in subdivision while preserving the overall density.

*Planning and Zoning Commission* shall mean the commission appointed by the City Council of the City of Bastrop to assist the City Council in planning and zoning within the City's corporate boundary. Same as Commission.

*Director of Planning* shall mean the person designated by the City Manager to oversee the planning Department and planning functions for the City and charged with the responsibility of administering the city's planning and zoning regulations.

*Plat* means the map, drawing, chart, or plan showing the exact layout of a subdivision into lots, block, streets, parks, school sites, drainageways, easements and/or any other element required by this

chapter which a subdivider shall submit for approval in accordance with this chapter. It shall include plan, plat or replat, both singular and plural.

*Policy* means a statement or document which has been enacted by the governing body of the city that forms the basis for enacting legislation or making decisions.

*Preliminary plat* means a formal document showing the detailed concept of the subdivision, presented with the required accompanying material to the Planning and Zoning Commission for approval. The graphic expression of the proposed overall plan for subdividing, improving and developing a tract shown by superimposing a scale drawing of the proposed land division on a topographic map and showing existing and proposed drainage features and facilities street layout and direction of curb flow, and other pertinent features with notations sufficient to substantially identify the general scope and detail of proposed development.

*Private access amenity plan* means a detailed plan to be submitted by the applicant that contains all the key elements for the private access development, including, but not limited to, private access control mechanisms, screening wall(s), signs and landscaping.

*Private deed restrictions* mean written stipulations which the developer imposes on buyer of property in the subdivision, such as, but not limited to, lot size, setback lines, building size, accessory buildings and permitted land use.

*Private street lot* means a separate lot owned by the property-owners association whereupon a private street is constructed.

*Private street.* A platted street providing limited local traffic circulation among adjacent lots which is privately owned and maintained, contained within a private street lot, and constructed in accordance with the requirements of this title.

*Property owners' association* means an organization established for the ownership, care, and maintenance of private streets and other private facilities.

*Public facilities* mean any facilities authorized or franchised by the city for the public welfare, usually including public utilities, governmental buildings and public schools.

*Public facilities system:* The water, wastewater, roadway, drainage or parks facilities owned or operated by or on behalf of the city to provide services to the public, including existing and new developments and subdivisions.

*Public improvements* mean facilities such as streets or drainage systems which are dedicated for public use.

*Public infrastructure improvement:* a water, wastewater, roadway, drainage or park facility that is part of one or more of the city's public facilities systems.

*Public open space easement* means an easement that restricts construction or plantings so that open space and/or sight visibility is maintained.

*Public utility and storm sewer easement* means an easement upon a private street not having the same width as the lot which is intended to contain a privately owned and maintained pavement as well as publicly owned and maintained water lines, sanitary sewer lines, storm sewers and such other utility or franchise infrastructure as can be reasonably accommodated.

*Public Wastewater Treatment and Collection System* shall mean a system that is installed and maintained by an entity which holds a wastewater CCN from the State and is served by a wastewater Treatment Facility which holds a discharge permit from the TCEQ, or successor entity.

*Replating* means the resubdivision of all or any part of any block or blocks of a previously platted subdivision, addition, lot or tract.

*Replat* shall mean a plat as defined in § 212.014 or § 212.015 of the Local Government Code and the procedure for such plats shall be the same as Standard Procedure as defined herein



*Residential Area* means any area within a subdivision plat which in whole or in part is platted for the development of dwelling units or residences, whether some be single-family, multifamily, owner occupied or rental dwelling units and including townhouses, duplexes, condominiums and apartments.

*Reserve strip* means a privately-owned strip of land, normally one foot in depth, adjacent to a public right-of-way or along the edge of a subdivision with the intent of preventing public access to the subdivision.

*Residential Replat* shall mean a replat that meets the criteria in Texas Local Government Code Section 212.015, more specifically that:

- (1) during the preceding five years, any of the area to be replatted was limited by an interim or permanent zoning classification to residential use for not more than two residential units per lot; or
- (2) any lot in the preceding plat was limited by deed restrictions to residential use for not more than two residential units per lot.

*Resubdivision* means a change in an approved or recorded subdivision plat if such change affects any street layout or area reserved thereon for public use, or any lot line. Same as Replat

*Retention pond* means a pond or other impoundment designed to store stormwater runoff permanently.

*Right-of-way* means lands dedicated to the public for use as a street, alley or crosswalk.

*Road bed width* means portion of street available for vehicular traffic.

*Rural Subdivision* shall mean a subdivision that has been designed to maintain the rural character are the area and meets the rural subdivision standards herein.

*Screening, Vegetative.* "Vegetative screening" means an area of at least ten feet wide, densely planted (or having equivalent natural growth with approved shrubs or trees at least four feet high at time of planting, of a type that will form a year-round dense screen approximately eight feet high with a minimum height of six feet.

*Screening, Wall or Fence.* "Wall screening" or "fence screening" means an opaque wall or barrier or fence at least six feet high.

*Secondary or Collector Street* shall mean a continuous street through several residential districts intended as a connecting street between residence districts and major streets or business districts.

*Shall or May:* The word "shall" shall be deemed mandatory, the word "may" shall be deemed permissive.

*Short Form Procedure* shall mean the procedure to be followed for the approval of the subdivision or resubdivision, of an existing lot when meeting certain conditions.

*Sidewalk* means a paved pedestrian way generally located within public street right-of-way, but outside of the roadway, and built in accordance with city specifications.

*Sketch plat* means a sketch drawing of initial development ideas superimposed on a topographic map to indicate generally the plan of development and to serve as a working base for noting and incorporating suggestions of the staff, City Engineer, utilities or others who are consulted prior to the preparation of the preliminary plat.

*Stacking area* means a setback measured from the public street right-of-way to the access controller.

*Steep slope* means areas that contain slopes over fifteen percent grade and are characterized by increased runoff and erosion hazards.

*Standard Procedure* shall mean the procedure to be followed for the approval of a subdivision when the land proposed to be subdivided does not meet the conditions of the short form procedure

*Standard Subdivision* shall mean any subdivision which is not "rural." Subdivisions within the City of Bastrop shall be classified as Standard Subdivision. On-site sewage facilities shall not be allowed in this subdivision classification.

*Stop work order* means a written directive issued by a city employee or authorized agent of the city to cease construction activity.

*Street* means a public right-of-way, however designated on the city's comprehensive plan, which provides vehicular access to adjacent land.

1. An *arterial* is designed to efficiently carry large volumes of traffic through the city.
  - a. *Principal arterials* provide a high degree of mobility by serving travel between major destinations or activity centers, as well as long-distance traffic that goes through or bypasses an area. They are designed to minimize travel time by providing high posted speed limits, offering physical separation from other roadways (e.g. few at-grade intersections) and providing a limited number of access/egress points.
  - b. *Minor arterials* are intended to connect traffic into and between the Principal Arterial System. They can serve trips of moderate length by connecting smaller geographic areas. While minor arterials provide slightly less mobility benefit than principal arterials, overall, they are characterized by relatively high travel speeds and low interference from cross traffic.
2. A *collector street* provides a balance between mobility and access, primarily serving to collect traffic from local streets and provide connections to arterials. In urban areas, collectors provide traffic circulation in residential areas or commercial districts, while in rural areas they primarily serve trips shorter than those served by arterials. Collectors are often categorized to reflect adjacent land uses, including residential, commercial, and mixed-use collectors.
3. A *local street* is one used primarily for access to abutting residential property. Also known as "minor" or "residential" streets.
4. A *major street* shall mean an arterial or collector.
5. A *private street* is a vehicular access way under private ownership and maintenance that has not been dedicated to the city or accepted by the city.
6. *Street, Internal*. "Internal street" means, generally any street whose entire width is contained within a development.
7. *Street, Perimeter*. "Perimeter street" means any street which abuts a development or one whose width lies partly within a development and partly without, unless otherwise defined by the City Engineer.
8. *Street Width*. The word "street width" shall be the shortest distance between the lines which delineate the rights-of-way of a street.

*Structure* means anything constructed or erected with a fixed location on the ground or attached to something having a fixed location on the ground. Among other things, structures include buildings, mobile homes, billboards, and poster panels.

*Subdivider* means any person or agent thereof, dividing or proposing to divide land to constitute a subdivision as that term is defined in this chapter. In any event, the term "subdivider" shall be restricted to include only the owner or equitable owner, of land sought to be subdivided.

*Subdivider's Agreement*. See Developer's Agreement.

*Subdivision* shall mean the division of any lot, tract or parcel of land into two or more parts to lay out a subdivision of the tract, including an addition to the City or its extraterritorial jurisdiction, to lay out suburban, building, or other lots, or to lay out streets, alleys, squares, parks, or other parts of the tract intended to be dedicated to public use or for the use of purchasers or owners of lots fronting on or adjacent to the streets, alleys, squares, parks, or other parts. A division of a tract under this subsection includes a division regardless of whether it is made by using metes and bounds

descriptions in a deed of conveyance or in a contract for a deed, by using a contract of sale or other executory contract to convey, or by using any other method. Each subdivision shall be classified as a rural or standard subdivision. Subdivision includes resubdivision and one-lot plats.

*Surety company* means an entity which undertakes to pay money or to do any other act, in event that their principal fails therein and is bound with the principal for the payment of a sum of money, or for the performance of some duty or promise.

*Surveyor* means a registered public surveyor, as authorized by the state statutes to practice the profession of surveying.

*Texas Department of Transportation and/or TxDOT* shall mean the state agency authorized by the State Legislature, or its successor agency, to regulate matters related to highway and road construction. (Note: When any TxDOT standard, "Item" regulation, definition or other matter is referenced, utilized, or adopted herein, the City also specifically adopts by this note of reference, and shall automatically apply without further amendment to this Code, the applicable successor TxDOT standard(s), "Item(s)", regulation(s), definition(s) or other matter(s), as amended by State law over time.)

*Thoroughfare* means the public vehicular infrastructure composed of arterials, collectors, and local streets. See Streets.

*Thoroughfare plan* means the officially adopted plan, a part of the comprehensive plan that identifies and classifies the existing and proposed thoroughfares in the city.

*Total Construction Cost* shall mean the direct cost to the developer of all construction contracts for the subdivision; items on [of] construction, including labor, materials and equipment necessary to complete all work (including extras) for final acceptance by the City.

*Tract* means an undivided parcel of land having access to a public street which can be subdivided into lots.

*Transmission lines* - Electric transmission lines are electric power lines operated at 50 KV or above as further described in Section 25.5 Substantive rules applicable to Electric Service Providers, Subchapter A, "General Provisions, Definitions" (#140). Gas, petroleum or like transmission pipelines are those facilitating transfer from one storage facility to another and more fully described in definition (25) Transportation or to transport under Texas Administrative Code Rule Title 16 Economic Regulation, Part 1 Railroad Commission, Chapter 3 Oil and Gas Division, Rule 3.79 Definitions.

*Utility easement* means an interest in land granted to the city, to the public generally, and/or to a private utility corporation or public utility district, for installing, maintaining, repairing or enlarging utilities across, over or under private land, together with the right to enter thereon with machinery and vehicles necessary for the installation, maintenance, replacement or enlargement of such utilities at any time.

*Vacation* means to cancel, rescind, or render an act that has the effect of voiding a subdivision plat or a portion thereof as public easement, right-of-way or other dedication.

*Yard* means a required open space, other than a court, unoccupied and unobstructed by any structure or portion of a structure from thirty inches above the general ground level of the graded lot upward, provided, however, that fences, walls, poles, posts, and other customary yard accessories, ornaments, furniture, and roof overhangs not exceeding thirty inches, may be permitted in any yard subject to height limitations and requirements limiting obstructions of visibility.

## Chapter 10.12 - ADMINISTRATION

### 10.12.005 - Planning and Zoning Commission.

- A. Acknowledgment is made of the prior creation, establishment and enumeration by the charter of the city of Bastrop of certain powers and responsibilities of the Planning and Zoning Commission, hereinafter referred to as the "Commission." The commission also has the authority and procedures outlined in the zoning ordinance (Sections 8 and 10) and as may be allowed by State law or may be delegated by the City Council. In addition, the commission shall exercise all the powers of approval or disapproval of plats, vacation of plats, and replats in accordance with state law, the City Charter, this chapter, and other ordinances of the city.
- B. In administering this chapter, the commission shall have the following responsibilities:
  - 1. Make recommendations to the city council regarding development policies that should be adopted to ensure the implementation of the comprehensive plan.
  - 2. Approve or disapprove applications regarding platting or subdividing land within the city limits of the city of Bastrop and its extraterritorial jurisdiction as follows:
    - a. Review and approve, conditionally approve, or disapprove requests for waivers or deferrals to the subdivision standards;
    - b. Review and approve, conditionally approve, or disapprove of preliminary plat proposals;
    - c. Review and approve, conditionally approve, or disapprove of short form final plats;
    - d. Approve or disapprove of phased development of a subdivision plat.
  - 3. Perform other planning duties which may be specifically assigned to the commission by the city council.

### 10.12.020 - Hearings and decisions.

- A. Public Hearings and Notice. Public notice will be given for replats if required by Section 212.015 of the Local Government Code.
- B. Rules of Order. Rosenberg's Rules of Order, latest revision, may be used as a guide on all questions of procedure and parliamentary law not covered by this section. These rules are guidelines only. Failure to strictly abide by these rules will not invalidate any action of the commission.
- C. Suspension of Rules. Any provision of these rules not governed by the city charter, code or state law may be suspended by a two-thirds vote of all members of the commission of which vote shall be entered upon the minutes.
- D. Order of Business. The chair shall call the commission to order, and the members present and absent shall be recorded. The minutes of any preceding meeting shall be submitted for approval. The public shall be advised of the procedures to be followed in the meeting.

The commission shall then hear and act upon those proposals scheduled for public hearing, together with any other matters of business, and report as the commission or Director of Planning finds to require commission consideration.
- E. Motions. A motion may be made by any member other than the presiding officer.
- F. Disqualification.
  - 1. A member shall disqualify themselves from discussion, debate and voting on any matter whenever they find that they have a personal or monetary interest in the property under appeal, or will be directly affected by the decision of the commission as defined by state law (Texas Local Government Code Chapter 171) or city ordinance.

2. A member may disqualify themselves from voting whenever any applicant, or their agent, has sought to influence the vote of the member on their application, other than in the public meeting. A member may visit the site without disqualification, provided that new information was gathered from the applicant or other parties, or any information gathered was conveyed to the full commission during the public hearing.

10.12.025 - Official records.

- A. Definition—Official Records. The official records shall be the minutes of the commission together with all findings, decisions and other official records of the commission.
- B. Recording of Vote. The minutes of the commission's proceedings shall show the vote of each member or if absent or failing to vote shall indicate that fact.
- C. Files—Retention. All matters coming before the commission shall be filed in the planning department in accordance with that department's general file system. At a minimum, records shall be retained in accordance with the city's record retention schedules.
- D. Public Record. The official records, filed for commission action in regular or special meeting, shall be on file in the planning department and shall be open to public inspection during customary working hours.

10.12.030 - Duties and authority of City Manager, Director of Planning, City Engineer and City Inspector.

- A. City Manager. The city manager is authorized and directed to recommend rules, regulations, standards and specifications for the construction, installation, design, location and arrangement of streets, driveways, visibility triangles, curbs, streetlights, street signs, alleys, utility layouts, utility easements, fences and gates for utility easements, sidewalks, fire hydrants, septic tanks, water wells, monuments, screening devices, criteria for drainage easement requirements, drainage facilities, and crosswalk ways for approval by the City Council. The city manager may recommend amendments to the same from time to time, for consideration and approval by the City Council. All such improvements shall be constructed, installed, designed, located and arranged by the subdivider in accordance with such rules, regulations, standards and specifications.
- B. Director of Planning. The Director of Planning or designee shall administer the provisions of these regulations and shall:
  1. Have the full care, custody and control of the minutes and other official records, shall attend to the correspondence of the commission, and shall cause to be given notices as are required and in the manner prescribed by statute, ordinance, and the rules of the commission.
  2. Serve as recording secretary and shall perform such duties as are necessary to prepare accurate and complete minutes of the commission's actions.
  3. Determine meeting dates in conformance with this chapter and prepare and post agendas for meetings in conformance with the Texas Local Government Code.
  4. Provide for publication in the official newspaper and make all written notices that may be required by the Texas Local Government Code and this chapter.
  5. Receive and file all sketch plats, preliminary plats, and final plats together with applications and fees.
  6. Forward copies of the sketch plat, preliminary plat, and/or final plat with supplementary materials as appropriate to the City Engineer, franchised utilities and commission.
  7. Discuss with any subdivider/developer the procedures for the approval of a subdivision plat.
  8. Review the sketch plat, classify the subdivision and recommend in writing to the Planning and Zoning Commission any land or park reservation.

9. Present a written report of recommendations as to classification of the subdivision, approval of the sketch plat, report of the engineering requirements, and other related materials to the commission at the public meeting.
  10. Review all plats to determine compliance with the regulations and any previous plat approvals and conditions.
  11. Make other recommendations in writing as required by these regulations or by the commission or city council.
- C. City Engineer. The City Engineer shall be an engineer licensed by the State of Texas, and shall:
1. Review and make recommendations regarding standard plat submittals and minor plats where public infrastructure improvements are involved;
  2. Review and recommend in writing, approval, conditional approval or disapproval of engineering requirements for the preliminary drainage plan as required on a preliminary plat;
  3. Review and recommend in writing, approval, conditional approval or disapproval of engineering and other requirements for the construction plans and calculations;
  4. Review and recommend in writing, approval, conditional approval or disapproval of any other related materials as required by the commission and/or city council;
  5. Issue notice to proceed and monitor construction.
  5. Issue a letter of acceptance of improvements upon satisfactory completion of all work on public improvements required for the subdivision.
- D. City Inspector. Under the supervision of the City Engineer, the city inspector shall:
1. monitor construction, and issue stop work orders where necessary.

#### 10.12.035 - Fees.

Fees for subdivision and development-related applications is codified in Article 10.03, Appendix A (Fee Schedule) of the Bastrop Code of Ordinances, as amended. Appropriate fees shall be paid upon submission of plats for consideration to the city. All fees shall be paid prior to application deadlines and shall not be refundable regardless of action taken by city approving authorities. The city council shall determine and revise the fee schedule as the need arises.

#### 10.12.040 - Reconsideration, appeals and finality of decisions.

- A. Reconsideration of Plats. Any individual or party aggrieved by any action of the Planning and Zoning Commission in the consideration of a preliminary plat, final plat or replat may request that the city council of the city of Bastrop review such action by the commission. Such request must be submitted in writing to the city secretary within five business days of such action. The city council shall then place such request upon a regular council agenda and provide the protesting party an opportunity for a hearing. The city council may, at its discretion, review the material submitted to and considered by the Planning and Zoning Commission relative to the disputed issue. After the hearing, the city council may or may not choose to forward such recommendations to the Planning and Zoning Commission as it deems appropriate. If a recommendation is forwarded to the Planning and Zoning Commission, the contested item will be rescheduled upon the next available Planning and Zoning Commission agenda, and the Planning and Zoning Commission will consider the city council recommendation and take such action as the Planning and Zoning Commission deems appropriate. Action by the Planning and Zoning Commission following consideration of the council recommendation will be final and nonappealable.
- B. Finality of Decisions. Except for those instances provided under subsection A of this section, all decisions of the Planning and Zoning Commission on plats and subdivisions are final, unless otherwise provided by the city charter or state law.

10.12.050 - Violations, penalties, and injunction.

Violation of any provision or provisions of this Ordinance by any subdivider shall constitute a misdemeanor and upon conviction of such violation in municipal court of the City of Bastrop, a fine as provided for in Section 1.01.009 of the Code of Ordinances of the City may be imposed, and each day that such violation continues shall be a separate offense. In case a corporation is the violator of any provision of this Ordinance, each officer, agent and/or employee in any way responsible for such violation thereof shall be individually and severally liable for penalties herein prescribed; provided, however, the penal provisions and application of this Ordinance shall not apply to a duly qualified county clerk and/or deputy county clerk acting in their official capacity; and provided further, however, that any violation of any provision of this Article outside the city limits, but within the City's extraterritorial jurisdiction, shall not constitute a misdemeanor, nor shall any fine be applicable to such violation within such extraterritorial jurisdiction; however, the City shall have the right to institute an action in the district court to enjoin the violation of any provision of this Article within the City's extraterritorial jurisdiction and seek all available civil penalties and remedies.

Penal Convictions. No conviction or convictions under the penal provision of this Article or the Texas Penal Code, shall ever be considered as any bar to any injunctive or other legal remedy, relief, right or power existing in the City of Bastrop, Texas, to endorse the application and provisions of this Article by virtue of the Constitution and laws of the State of Texas.

- A. On behalf of the city, the City Attorney shall, when directed by the city council, institute appropriate action in a court of competent jurisdiction to enforce the provisions of this chapter or the standards referred to in this chapter with respect to any violation thereof which occurs within any area subject to all or a part of the provisions of this chapter.
- B. In addition, any abutting owner or lessee or other person prejudicially affected by the violation of the terms of this chapter may resort to any court of competent jurisdiction for any writ or writs, or to obtain such relief, either in law or equity, as may be deemed advisable in these premises.
- C. If any subdivision exists for which a final plat has not been approved or in which the standards contained in this chapter or referred to in this chapter have not been complied with in full, the city council shall pass a resolution reciting the facts of such non-compliance and failure to secure final plat approval. The city secretary or designee shall, when directed by the city council, cause a certified copy of such resolution under the corporate seal of the city to be filed in the Deed Records of Bastrop County. If full compliance and final plat approval are secured after the filing of such resolution, the Director of Planning or designee shall forthwith file an instrument, in the Deed Records of Bastrop County stating such.
- D. Any person, firm or corporation who shall violate or cause or permit anyone to violate any of the provisions of this chapter shall be guilty of a misdemeanor, and upon conviction therefore shall be fined an amount not to exceed the specified in Section 1.01.009 of the Bastrop Code of Ordinances. Each day that such violation thereof shall exist is declared to be a distinct and separate offense and punishable as such. The same fine amounts shall apply to civil penalties when available.
- E. The city shall have and retain the right of injunctive relief against any person, firm or corporation who is in the process of or about to violate any section, paragraph or part of this chapter. Such right for injunctive relief shall exist independent of any other penalty provisions of this chapter and not in lieu thereof. The right for injunctive relief is essential to the city that it maintains an orderly, properly planned, and properly engineered control over subdivisions thus protecting the health, morals, safety and well-being of the citizens and halting any attempt by any person, firm or corporation to inflict temporary or permanent injury on the general public by a failure to comply with the terms of this chapter.

## Chapter 10.16 - PLAT PROCEDURES, STANDARDS, AND SPECIFICATIONS

### Sections:

#### 10.16.005 - General procedures.

- A. No preliminary or final plat for a subdivision shall be approved by the Planning and Zoning Commission or city staff and no completed improvements shall be accepted by the city unless they conform to the following standards and specifications:
  1. Standard Operating Procedures. The procedures established by this chapter, which detail application procedures, filing dates, review, filing fees as set by the fee schedule, standards for sketch plats, preliminary plats, final plats, and any accompanying material;
  2. Sketch Plat Submittal and Classification. All subdivisions require the submittal of a sketch plat for the classification of subdivisions into standard plat, short form plat, administrative plat or residential replat as established by this chapter;
  3. Construction Standards Manual. The design standards, criteria, standards and specifications as adopted by the city council and adopted requirements regarding the physical appearance and other standards for the subdivision and for the construction of streets, drainage, water and sewer, and other public facilities;
  4. Other Standards. The provisions of the City's Building Code (International Building Code series), and any other city ordinances which are applicable to the subdivision.
- B. The applicant should confer with the planning staff prior to the preparation of a sketch plat and discuss the procedure for obtaining approval of a subdivision plat and the requirements as to the general layout and arrangement of lots, blocks and streets, and minimum design and construction requirements for streets, storm drainage, sewerage and water improvements.

#### 10.16.010 - Classification of subdivisions.

Each subdivision application shall be reviewed and classified by City Staff at the time of the Sketch Plat review by process, location, and applicable design standards. Processes include Standard, Short Form, Administrative and Residential Replats. Locations includes subdivision within the city limits, within the City's statutory extraterritorial jurisdiction (ETJ), or within the City's voluntary ETJ-Area A or voluntary ETJ-Area B. Finally, it will be determined whether each subdivision will use the City or Rural design standards, depending on its location.

- A. Process Classifications: The Director of Planning will designate each plat application to use one of the following four processes: standard, short form, administrative, residential replat, or one of several miscellaneous plat types.
  1. Standard Plat Process. Any division of land into two or more lots shall use the standard plat process, unless the conditions of a short form plat, administrative plat or residential replat process are applicable. Following the submission and approval of a sketch plat, a standard plat requires the submission and approval of a preliminary plat prior to approval of a final plat. The preliminary plat and final plat requires approval by the Planning and Zoning Commission.
  2. Short Form Plat Process. In cases where the proposed subdivision is not complex, a plat may be designated for use of the Short Form process. The Short form process is generally applicable for initial platting and simple replats:
    - a. not more than six (6) lots are created,
    - b. such land abuts upon a street of adequate width and is so situated that no additional streets and no alleys, easements or other public dedications of property are required.



- c. All required utilities are in place to serve each parcel or lot of such subdivision or resubdivision, or a development agreement to provide such utilities has been approved by the City Council.
- d. The topography of the tract and the surrounding lands is such that an engineer's sealed letter attests that no adverse impact will occur and that no regard need be given in such subdivision to drainage. If drainage facilities are required, this short form cannot be used.
- e. Each lot meets the minimum lot requirements as set forth in the zoning regulations and/or Section 10.32.040.B and does not require any variance or exception to regulations. The resubdivision of any lot, tract or parcel of land within a rural subdivision shall not be permitted if the proposed lot(s) size will be less than one (1) acre.
- f. The perimeter of the tract being subdivided has been surveyed and marked on the ground, and each corner of each lot of such proposed subdivision has been marked on the ground and is tied to a corner of the tract being subdivided. A plat thereof shall be filed with the City as outlined in Section 10.16.030, and
- g. other criteria are met.

Following the submission and approval of a sketch plat, a short form plat requires the submittal of a final plat and approval by the Planning and Zoning Commission (and doesn't require a preliminary plat).

3. Administrative Plat Process. Minor plats, amending plats, and certain replats can be designated to use the Administrative Process. To facilitate the subdivision plat approval process in those instances (including minor street dedication, easement dedication, amending plats and replats) where the highly formalized standard plat approval procedure is not necessary for an understanding of a given development process or the effects and implications thereof, or for the protection of proximate individual interest, or for the protection and guidance of community interests, or for the protection and guidance of community development as a whole, the administrative plat approval procedure may be used when the conditions have been met. The Administrative Process is similar to the Short Form Process, with the exception that the final plat is approved by the Director of Planning.
  - a. The administrative procedure may be followed for the approval of an Amending Plat, replat or a small subdivision when the land proposed to be subdivided or resubdivided meets the following conditions and requirements in accordance with Local Government Code Section 212.0065:
    - (1) Amending plats as defined in Section 10.12.010 above (and otherwise defined in Texas Local Government Code Section 212.016).
    - (2) Minor plats or replats involving four or fewer lots fronting on an existing street and not requiring the creation of any new street or the extension of municipal facilities. Minor plats must meet the following conditions:
      - (a) The minor plat and supporting information are respectively drawn and compiled in compliance with the final plat specifications as hereinafter provided;
      - (b) The minor plat and supporting information and the subdivision they represent are not otherwise in contravention with Chapter 212, Local Government Code;
      - (c) Each lot and block have frontage upon a dedicated and improved street to city specifications, or necessary dedication and improvements are part of the plat;
      - (d) All easements to each block, or lot have been previously granted or are shown on the plat;
      - (e) The proposed development neither contains nor creates a significant drainage problem, nor is topography a salient development consideration;

- (f) All utilities required to serve each block, or lot are in place or arrangements to provide same have been made with the appropriate agency;
  - (g) If the subject property is not identifiable by reference to a previously recorded subdivision plat and is to be platted as a single tract, the tract shall have street frontage of not less than the minimum specified by the zoning ordinance, this chapter, or the design standards and criteria;
  - (h) Subject property shall involve a maximum of four lots;
  - (i) Lot width and total lot area vary no more than five percent less than the equivalent dimensions of abutting lots;
  - (j) Property which has previously had a total of four lots platted from it via the minor plat procedure shall not have additional lots platted from it under the minor plat procedure.
- (3) A replat under Texas Local Government Code Section 212.0145 that does not require the creation of any new street or the extension of municipal facilities.
- b. The City Council hereby delegates approval authority as per Local Government Code Section 212.0065 to the Director of Planning.
  - c. The Director of Planning shall not disapprove the plat and shall be required to refer any plat which the Director of Planning refuses to approve to the planning commission within thirty (30) days.

The minor plat requires a sketch plat and final plat, which is approved by the Director of Planning.

#### 4. Replats and Residential Replats.

Replats may be classified as Standard process, Short Form Process or Administrative Process, depending on their complexity.

- a. A replat of a subdivision or part of a subdivision may be recorded and is controlling over the preceding plat without vacation of that plat if the replat:
  - 1. is signed and acknowledged by the owners of the property being replatted;
  - 2. is approved, after a public hearing on the matter at which parties in interest and citizens have an opportunity to be heard, by the municipal authority responsible for approving plats; and
  - 3. does not attempt to amend or remove any covenants or restrictions.
- b. A replat shall include modification of an existing plat that creates new lots or alters any previously dedicated rights-of-way or easements, as provided in Sections 212.014 and 212.015 of the Texas Local Government Code. Any replat that meets the requirements of an amending plat (Section 212.016) including the combination of existing lots, may be processed as a minor plat.
- c. If during the preceding five years, any of the area to be replatted was limited by an interim or permanent zoning classification, to a residential use for not more than two residential units per lot; or any lot in the preceding plat was limited by deed restrictions to a residential use for not more than two residential units per lot, are classified as Residential replats and the notice and voting requirements of Section 212.015, Local Government Code, are applicable and must be followed.

#### 5. Miscellaneous Plats

- a. Vacating plats - A recorded plat may be vacated in accordance with the procedures and requirements set forth in Section 212.013 of the Local Government Code.

- (1) Before the Sale of Any Lot. Before the sale of any lot within a plat, the plat may be vacated upon application of the proprietors of the land included in the plat, and after

approval by the commission. The vacation of the plat does not take effect until the filing of a written instrument declaring the plat to be vacated has been executed, acknowledged, and recorded by the county clerk of Bastrop County.

- (2) After the Sale of Any Lot. After the sale of any lot within a plat, the plat or any part of the plat may be vacated upon the application of the owners of all the lots in the plat and after approval by the commission. The vacation of the plat does not take effect until the filing of a written instrument declaring the plat or a part of the plat to be vacated has been executed, acknowledged, and recorded by the county clerk of Bastrop County.
  - (3) Rejection. The commission may reject any application for vacating a plat which abridges or destroys any public rights in any public uses, improvements, streets or alleys.
- b. Replats and Amending Plats. After the sale of any lot within a plat, unless the owners of all the lots in the plat request vacation of the plat or a part of the plat, the plat may be changed only after compliance with the replatting process in accordance with Section 212.014 and Section 212.015, Local Government Code, or the amending process in accordance with Section 212.016, Local Government Code. The commission may approve and issue an amending plat, which may be recorded and controlling over the preceding plat without vacation of that plat and without notice and hearing, if the amending plat is signed and acknowledged by the owners of the property being replatted and is solely for one or more of the following purposes:
- (1) If the amending plat involves four or fewer lots fronting an existing street and does not require the creation of any new street or the extension of municipal facilities, it may be approved by the Director of Planning. The Director of Planning may, for any reason, present the plat to the commission for approval and shall refer the plat to the commission if he or she refuses to approve the plat.
  - (2) Procedure.
    - i. An application for vacating or amending a plat shall be filed with the Planning and Zoning Commission on forms provided by the Director of Planning or designee.
    - ii. The appropriate application fee as set forth in the fee schedule shall be paid at the time of application.
    - iii. Amended plats should meet the same requirements set forth in the ordinance as for minor plats.
    - iv. The Planning and Zoning Commission may approve, conditionally disapprove or disapprove any amending plat or vacation request in accordance with the procedures for plat approval set forth in this chapter.

#### 10.16.015 – Procedural Process.

All subdivision applications will be assigned a procedural process by the Director of Planning at the time of the Sketch Plat review. Procedures include the Standard Process, Short-Form Process, Administrative Process and Residential Replat Process.

Any owner or developer of any lot, tract, or parcel of land located within the city limits of the city or within its extraterritorial jurisdiction who may wish to affect a subdivision of such land shall conform to the general procedure described as follows:

#### A. Application Procedures applicable to all processes.

1. Written Request Required. Every proposal submitted for commission action shall be made in writing on application forms provided by the city, and shall be accompanied by all prescribed fees, and shall be complete in all respects before being accepted for filing.

2. Filing Deadline. Staff will schedule meetings to review sketch plat submittals on a weekly basis. Every other proposal shall be filed with the Director of Planning not later than noon the Thursday twenty-eight (28) days prior to the regular meeting date of the commission. When the filing deadline falls on a city holiday, the following workday shall be observed as the filing deadline. Failure to submit a complete application on time will result in the rejection of the application unless undue hardship can be demonstrated.
  3. Notice. Public notice of proposals to amend the boundaries of zoning districts or preliminary plats or residential replats as defined in Section 212.015 of the Local Government Code shall be sent, at the minimum, to the applicant and/or their agent and to the owners of all properties laying within two hundred feet of the property in question, as said ownership appears on the last approved city tax roll. Notice shall be given in writing deposited in the United States Mail, postage prepaid, not less than fifteen days prior to the date of commission hearing. The notice of the hearing shall advise that a specific proposal has been submitted, shall state the date, time and place of hearing, shall state that further information may be obtained relative to the proposal at the office of the Director of Planning.
  4. Submission of Supporting Information. Information supporting a recommendation to approve or disapprove any proposal before the commission shall be submitted only through the Director of Planning or to the commission in a public meeting.
  5. Withdrawal of Proposal. When any applicant desires to withdraw any proposal, they may do so by filing a written request to that effect with the Director of Planning. Such request shall not be effective unless and until approval of the withdrawal by the commission at the public meeting.
  6. Dormant Applications. Any application that has been classified as incomplete, and related preliminary or final plat has not been approved by the City, and no further activity has been demonstrated to the City, shall be considered null and void six months after the date of the application's submittal, or ninety days after the most recent submittal in support of the application, whichever is later.
- B. Sketch Plat-Preliminary Conference and Sketch Plat Review.
1. Preliminary Conference. Prior to the official filing of a preliminary plat, the subdivider should consult with and present a proposed plan (sketch plat) of subdivision to the Director of Planning for comments and advice of the procedures, specifications, and standards required by the city for the subdivision of land.
  2. Before submitting the sketch plat and conceptual site drainage plan, the applicant should discuss with the planning staff and City Engineer the procedure set for the adoption of a subdivision plat and the requirements of the "Design Standards," the iSWM <sup>TM</sup> Design Manual and of any pertinent city ordinances. Planning staff and City Engineer shall also advise the applicant of existing conditions which may affect the proposed subdivision, such as existing or proposed streets, adjacent subdivisions or properties, floodplain and drainage, sewage, fire protection, reservation of land, and similar matters, referring the applicant to the proper agencies if services are not provided by the city.
  3. Sketch Plat Review. Sketch plat review will normally be accomplished by submission of the sketch plat material as described in Section 10.20.040(A) and a conference with the Director of Planning.
    - a. Three (3) copies of the Sketch Plat
    - b. Two (2) copies of the Conceptual Site Drainage Plan, in accordance with Section 10.28.010.C (if applicable)
    - c. One copy of all submittal materials in digital format (if applicable).

The Director of Planning, or their designee, shall determine the location of the project (within city, within statutory ETJ, within voluntary ETJ Area A, or within voluntary ETJ Area B); determine the type of plat (Standard or Rural); and the applicable process (Standard, Short

Form or Administrative.) The Director of Planning, or their designee, will provide comments identifying compliance or noncompliance with applicable ordinances and standards, elements of the comprehensive plan, and suggestions for improvement in design to either comply with the applicable ordinances and standards or to improve circulation, drainage, or compatibility with adjacent neighborhoods. The applicant should make every effort to comply with the suggested changes or to respond in writing to the Director of Planning as to why the changes will not be made. These suggestions and responses will be made a part of the staff report on any future plat submittal where the discrepancy remains. Waivers from these requirements will require a waiver under the terms of Section 10.04.035.C. Conflicts with the comprehensive plan shall be resolved by requesting an amendment to the comprehensive plan before proceeding with the plat. Appeals on suggested design changes will remain the discretion of the Planning and Zoning Commission. Approval of the sketch plat does not constitute acceptance of the subdivision but is merely a review procedure prior to submittal of the formal preliminary plat.

4. No sketch plat or replat shall be accepted for processing if it is determined to be administratively incomplete by the Director of Planning.
5. Upon receiving the sketch plat, the Director of Planning shall classify the subdivision as standard, replat, or minor plat, review and discuss the plat along with its accompanying reports and other relevant material with the applicant and shall advise the applicant in writing of the specific changes, if any, required by city ordinance or regulation as a prerequisite for approval, and any additional changes required.

The process for Sketch Plat review is shown in Figure 10-1.

#### 10.16.020 Standard Process

Subdivisions that are classified for the Standard Process are required to submit a preliminary and final plat for review and approval, as described below. A summary of the process is contained in Figure 10-2.

- A. Preliminary Plat. Following submittal and review of the required Sketch Plat, if the subdivision has been designated for the Standard Process during the Preliminary Conference, the subdivider shall prepare and submit to the Planning and Zoning Commission a preliminary plat for its consideration and approval. If the subdivision has been designated to use the Short Form or Administrative Process, then the applicant will proceed to the submittal of a Final Plat as described in paragraph 10.16.020.B below:
  1. Preliminary Plat Submission: Following submittal and review of the required sketch plat, the applicant shall file an application for preliminary plat approval on a form provided by the Director of Planning or designee not less than twenty-eight (28) days prior to the commission meeting at which the plat shall be considered. The preliminary plat shall be prepared by a registered surveyor or engineer in accordance with this chapter and accompanied by necessary engineering information prepared by a registered engineer. The submission of a preliminary plat is necessary to eliminate the duplication of subdivision names and street names; assure proper alignment of streets and drainage facilities; assure that adequate public utility services will be provided; assure that all necessary permits and plan approvals have or will be applied for; and assure conformance with the comprehensive plan and other development regulations. The subdivider shall submit a preliminary plat of the entire area being subdivided. Prior to the plat being placed before the Commission for consideration, the plat must be accepted as

Figure 10-1

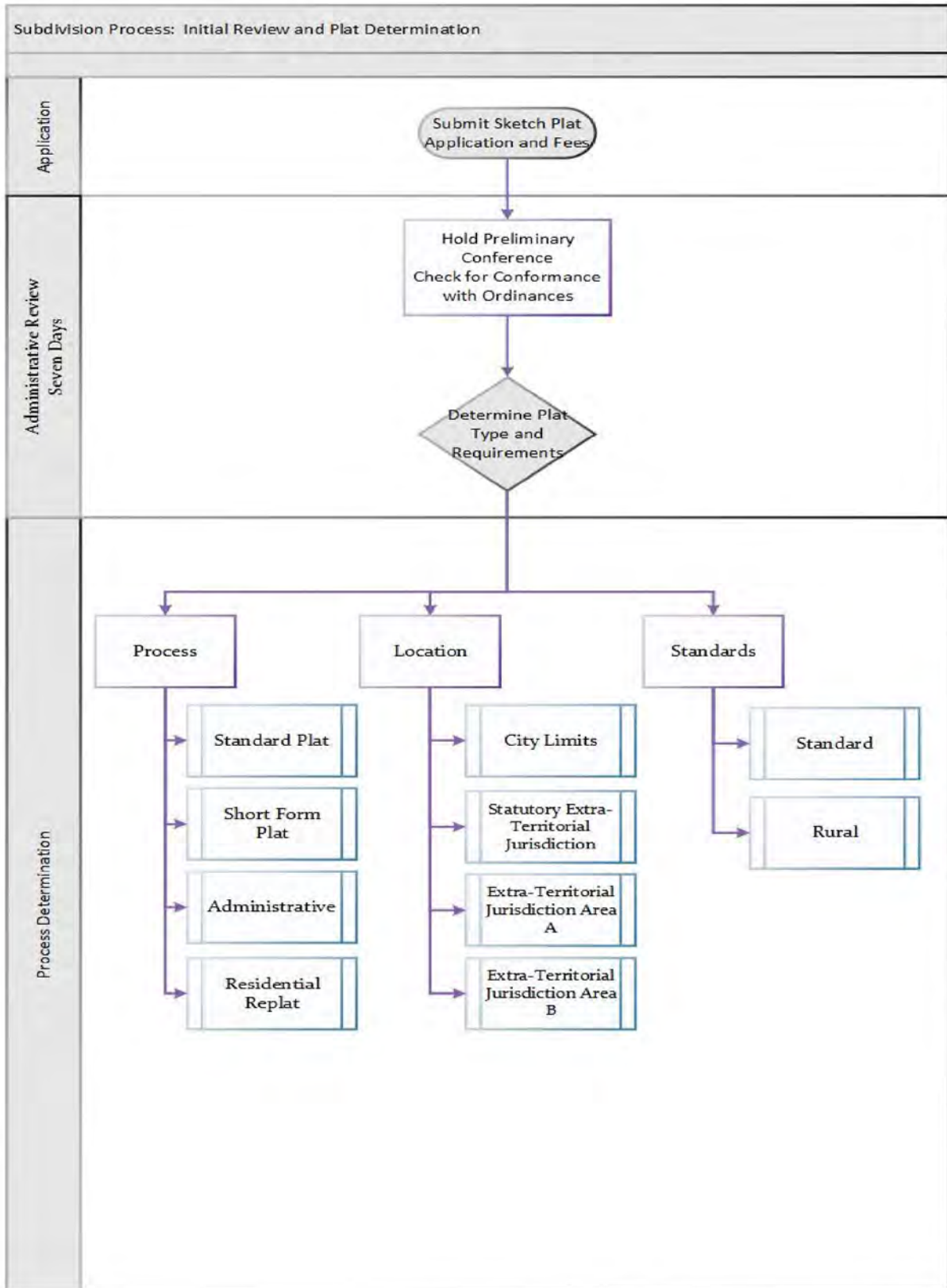
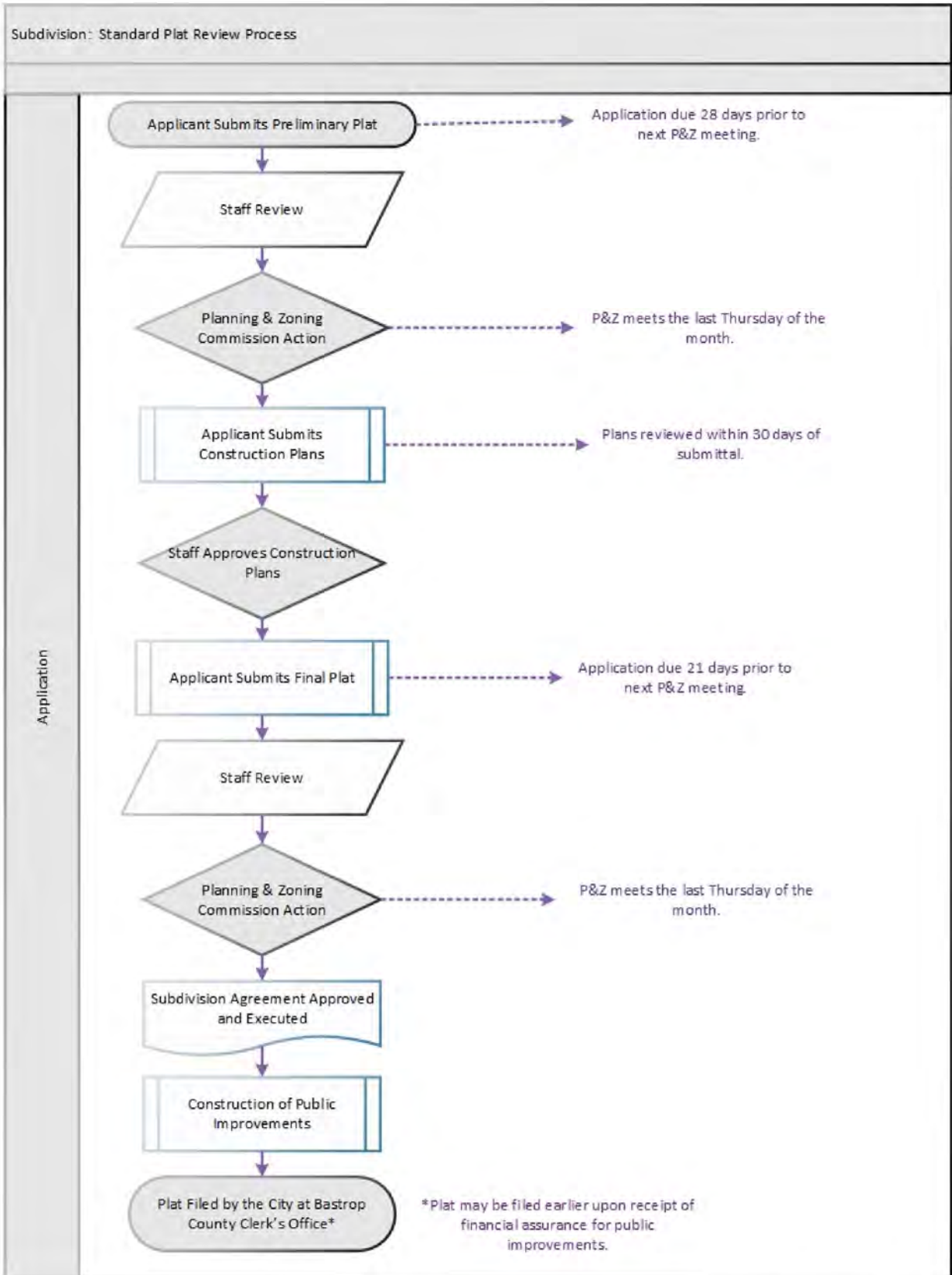

Figure 10-2



administratively complete by the Director of Planning. A plat that contains the information set forth in Section 10.20.010.B is considered administratively complete.

2. Submittal Requirements-Copies Required. As part of the preliminary plat application, the subdivider shall submit:
  - a. Five (5) legible twenty-four by thirty-six-inch (24" X 36") or eighteen by twenty-four inch (18" by 24") paper copies, plus one copy at eleven by seventeen inches (11" X 17") of the proposed preliminary plat shall be submitted to the Director of Planning as part of the application in the format and containing the information required in Section 10.20.040.B below.
  - b. Five (5) copies of the completed preliminary plat application form and completed preliminary plat checklist.
  - c. One (1) digital copy of the preliminary plat (.dwg format, spatially referenced to NAD 1983 State Plane Coordinates-Texas-Central-FIPS-4203-Feet) and all other elements of preliminary plat submitted must also be submitted in electronic format
  - d. The required preliminary plat filing fee as set forth in Section A10.03 of the Bastrop Code of Ordinances.
  - e. Three (3) copies of the preliminary drainage plan, preliminary water and sewer plan, preliminary street plan, and preliminary lot grading plan.
  - f. Two (2) copies of the Tree Inventory and Preliminary Tree Mitigation calculations.
  - g. Two (2) copies of the Preliminary Street Tree Plan.
  - h. A written request for any waivers or deferrals, if necessary, within the subdivision and citing the ordinance provision and section to which a waiver or deferral is being requested.
  - i. When the subdivision is a portion of a larger tract later to be subdivided in its entirety, a general development plan of the entire subdivision, showing a schematic layout of the entire subdivision showing the tentative proposal for streets, blocks, and drainage improvements for such areas, in the entire tract, shall be submitted with the preliminary plan of the portion first to be subdivided. Acceptance or approval of the said general development plan does not release the subdivider from submitting a preliminary plat for each section to be developed to compare with the general development plan. The general development plan may be required by the City to show and provide continuous public utility easements for the construction of future utilities through the subdivision for service to adjoining property. Such easements shall have sufficient setback requirements to accommodate construction of future utilities.
3. The Director of Planning will mail a notice to each property owner of all adjacent property owners and other property owners within two hundred (200') feet of the property proposed to be subdivided, with addresses as recorded by the County Appraisal District hereof each and every time that a subdivision proposal is pending before the Planning and Zoning Commission, which notice shall include the date, place and time of each subdivision consideration.
4. Processing of Preliminary Plat. The city shall coordinate review of the preliminary plat with appropriate public agencies and utilities. Formal consideration of the preliminary plat will be scheduled for the next regularly scheduled meeting of the Planning and Zoning Commission following the posted filing deadline.
  - a. The Director of Planning and City Engineer shall make review comments to the Planning and Zoning Commission. The Director of Planning, or designee, shall make public notice available of the scheduled public hearing as required by state law.



- b. No preliminary plat or preliminary replat shall be approved unless it is shown to follow the comprehensive plan. A preliminary plat or preliminary replat will not be accepted for processing if all or any portion of the land area encompassed within the plat is included in or directly affected by any proposed amendment to the comprehensive plan, if such amendment has been set for formal presentation to the Planning and Zoning Commission or the city council by placement on a formal agenda.
  5. Action Taken by Planning and Zoning Commission: The Planning and Zoning Commission shall review and act upon the preliminary plat within thirty (30) days from the date said plat is accepted as complete by the Director of Planning. A plat that contains the information set forth in Section 10.20.010.B is considered administratively complete. The complete preliminary plat submittal including requisite fee shall be considered filed on the application deadline date for the meeting twenty-nine days prior to the Planning and Zoning Commission meeting. A plat that is denied for administrative incompleteness shall not be subject to the thirty-day review. The Planning and Zoning Commission shall approve, conditionally approve, or disapprove of the preliminary plat.
  6. If a preliminary plat is approved by the commission subject to certain conditions, two copies of a revised preliminary plat and one copy in electronic format (including revised grading, drainage, utility, tree survey plan and any other element of the preliminary plat that requires revision) reflecting those conditions shall be submitted to the Director of Planning within sixty (60) days after approval or the approval lapses unless the applicant demonstrates good cause for delay in submitting the revised preliminary plat. The revised preliminary plat submittal shall be reviewed by the Director of Planning and City Engineer for compliance with conditions of commission approval. Submission of a final plat of the total area of a preliminary plat within sixty days reflecting the conditions approved shall meet the requirements of this provision. If the required submission is not made within sixty days, the preliminary plat shall be considered void.
  7. Expiration of Preliminary Plat Approval: The Preliminary Plat often is the initial permit for a project under Texas Local Government Code Section 245. Approval of the preliminary plat does not constitute acceptance of the subdivision but is authority to proceed with the preparation of the final plat. Any work done on the subdivision before the final plat is accepted and recorded is done at the risk of the subdivider. Approval of a preliminary plat expires at the end of two (2) year from the date of Planning and Zoning Commission action unless a final plat has been submitted for approval. The Commission, if written request from the subdivider is received prior to the end of the two-year period, grant an extension for up to two additional years upon a majority vote of the Planning and Zoning Commission if a developer demonstrates good cause why the authorization should continue. Only one such extension shall be granted. The submission of a final plat application for a portion of a phased development project extends authorization of the remaining portion of the preliminary plat by an additional two years from filing of the latest final plat.
  8. Approval of a preliminary plat by the commission shall be deemed an expression of approval of the layout submitted on the preliminary drawings as a guide to the installation of streets, water, sewer and other required improvements and utilities and to the preparation of the final plat. Approval of the preliminary plat does not constitute acceptance of the subdivision but is merely an authorization to proceed with preparation of the final plat for record.
  9. No construction, including grading, shall be commenced on the subdivision prior to acceptance of the final plat and the notice to proceed is issued by the City Engineer.
- B. Final Plat
1. The submission of a final plat is necessary to assure proper identification and location of all streets, lots and easements; assure that the streets will be properly constructed and maintained; assure that public utilities systems have been approved; assure that all proper dedications have been made for streets, easements, and public spaces; and, assure that all necessary permits have been obtained or applied for. The application shall include the plat

and be accompanied by appropriate engineering plans, soils reports, and other necessary information, and the appropriate filing fee. Patching and pasting of paper attachments is not acceptable. All figures and lettering shall be neat and easily legible. For final approval, the final plat must comply in all respects with the approved preliminary plat.

2. Submittal Requirements-Copies Required. As part of the final plat application, the subdivider shall submit:
  - a. Five (5) legible twenty-four by thirty-six inch (24" X 36") or eighteen by twenty-four inch (18" by 24") paper copies, plus one eleven by seventeen inch (11" X 17") paper copy, of the proposed final plat shall be submitted to the Director of Planning as part of the application in the format and containing the information provided in Section 10.20.050.C below, all necessary easements and all conditions of the preliminary plat approval by the Planning and Zoning Commission. The submittal shall include a completed final plat application, the prescribed final plat fee, and it shall be accompanied by copies of site improvement data bearing the seal of an engineer and a detailed cost estimate for public improvements as required. The final plat application shall also be accompanied by copies of the final drainage plan, in accordance with Section 10.28.010.H.3.
  - b. Five (5) copies of the completed final plat application form and completed final plat checklist.
  - c. One (1) digital copy of the preliminary plat (.dwg format, spatially referenced to NAD 1983 State Plane Coordinates-Texas-Central-FIPS-4203-Feet) and all other elements of final plat submittal must also be submitted in electronic format.
  - d. The required final plat review and filing fee as set forth in Section A10.03 of the Bastrop Code of Ordinances.
  - e. Two (2) copies of the Tree Inventory and Preliminary Tree Mitigation calculations.
  - f. One copy of the private deed restrictions, if any, as filed in the records of Bastrop County;
  - g. Four (4) full-size (24" X 36"), two (2) half-size (11" X 17"), and one (1) digital copies of construction plans for public improvements, as described in Section 10.28.010.H;
  - h. Cost estimates signed by a Licensed Professional Engineer for street, drainage and utility improvements including estimated quantities, unit prices, and contingencies.
  - i. The Subdivider wishing to amend or replat property must provide a complete copy of the original plat and a signed written statement stating which features of the plat are to be changed.
  - j. A Developer's Agreement and financial assurance as required in Section 10.28.020 providing good and sufficient bond for the proper construction of the streets, drainage and utilities.
  - k. Documents from any other utility and/or service companies serving the immediate area (electric power, telephone, and gas) which state what service will be available to the subdivision.
  - l. Current tax certificates stating that all taxes (County, City, school) are paid.

3. Engineering Plans for Public Improvements.

When submitted, the final plat shall be accompanied by the construction plans for public improvements, as described in Section 10.20.020 of this code and the final drainage plan. Concurrent with the review of the final plat, the Director of Planning and City Engineer shall review the engineering plans and specifications for all required public improvements for conformance with the city standards. The final plat application shall be considered incomplete, and processing suspended, until the engineering plans and financial assurance instruments are approved and accepted. Formal acceptance of the final plat for processing will not occur until approval of the site improvement engineering data is accepted by the city.

- a. The City will prepare a draft Developer Agreement for the provisions of the required public improvements and a completed form of performance and/or surety bonds or other surety funds as prescribed in Section 10.28.020, for submittal to the City Attorney for approval. The City Council shall be satisfied that the subdivider will be in a financial position to install or cause to be installed at the subdivider's own cost, risk and expense all the improvements herein required. The City Council shall require such security as it in its sole and absolute discretion may deem best to ensure the orderly development within any subdivision, specifically including, but not limited to, a performance bond equal to the estimated cost of the improvements, to secure the estimated cost of such improvements. It is expressly understood that as a condition to the approval of said subdivision, no permanent City utilities shall be furnished to any lot within said subdivisions until all improvements required by this ordinance are completed within the block in which said lot is contained and all such improvements have been accepted by the City of Bastrop.
4. The final plat shall be filed with the Director of Planning at least twenty-eight (28) days prior to the meeting at which approval is requested. Prior to the plat being placed before the Planning and Zoning Commission for consideration, the plat must be accepted as administratively complete by the Director of Planning. A plat that contains the information set forth in Section 10.20.010.C is considered complete.
5. The Director of Planning will mail a notice to each property owner of all adjacent property owners and other property owners within two hundred (200') feet of the property proposed to be subdivided, with addresses as recorded by the County Appraisal District hereof each and every time that a subdivision proposal is pending before the Planning and Zoning Commission, which notice shall include the date, place and time of each subdivision consideration.
6. Filing Fees and Security
  - a. Applicable fees and charges shall be paid into the general fund of the City of Bastrop when any plat is tendered to the Director of Planning. All applicable fees and charges shall be paid in advance, and no action of the Planning and Zoning Commission shall be valid until all fees have been paid. The Director of Planning, deputies or assistants shall calculate the fees and charges which shall be as set forth in City of Bastrop Code of Ordinances Appendix A, Article 9 [A10.03, section A10.03.002] Subdivision and Development Plat Fees.
  - b. The above fees shall be charged on all plats regardless of the action taken by the City Council.
  - c. An escrow amount calculated as a percentage of the total estimated construction cost, shall be put on deposit with the City, to cover the costs of review of construction plans, construction inspections, all testing associated with construction within the subdivision and administration associated with the construction phase of the subdivision. The City Engineer, deputies or assistants shall calculate the escrow fee as set forth in City of Bastrop Code of Ordinances Appendix A Article 10 [A10.03, Section A10.03.003] Subdivision and Development Escrow Fees. Any unused amount of the escrow deposit shall be returned to the developer after final acceptance of the subdivision by the City. Should the escrow deposit be depleted, the City Council may require an additional sum to be deposited.

#### 10.16.025 Short Form Process

Plats that are designated for the Short Form process can proceed directly to the preparation of a Final Plat, as described below. A summary of the process is shown in Figure 10-3.

Figure 10-3

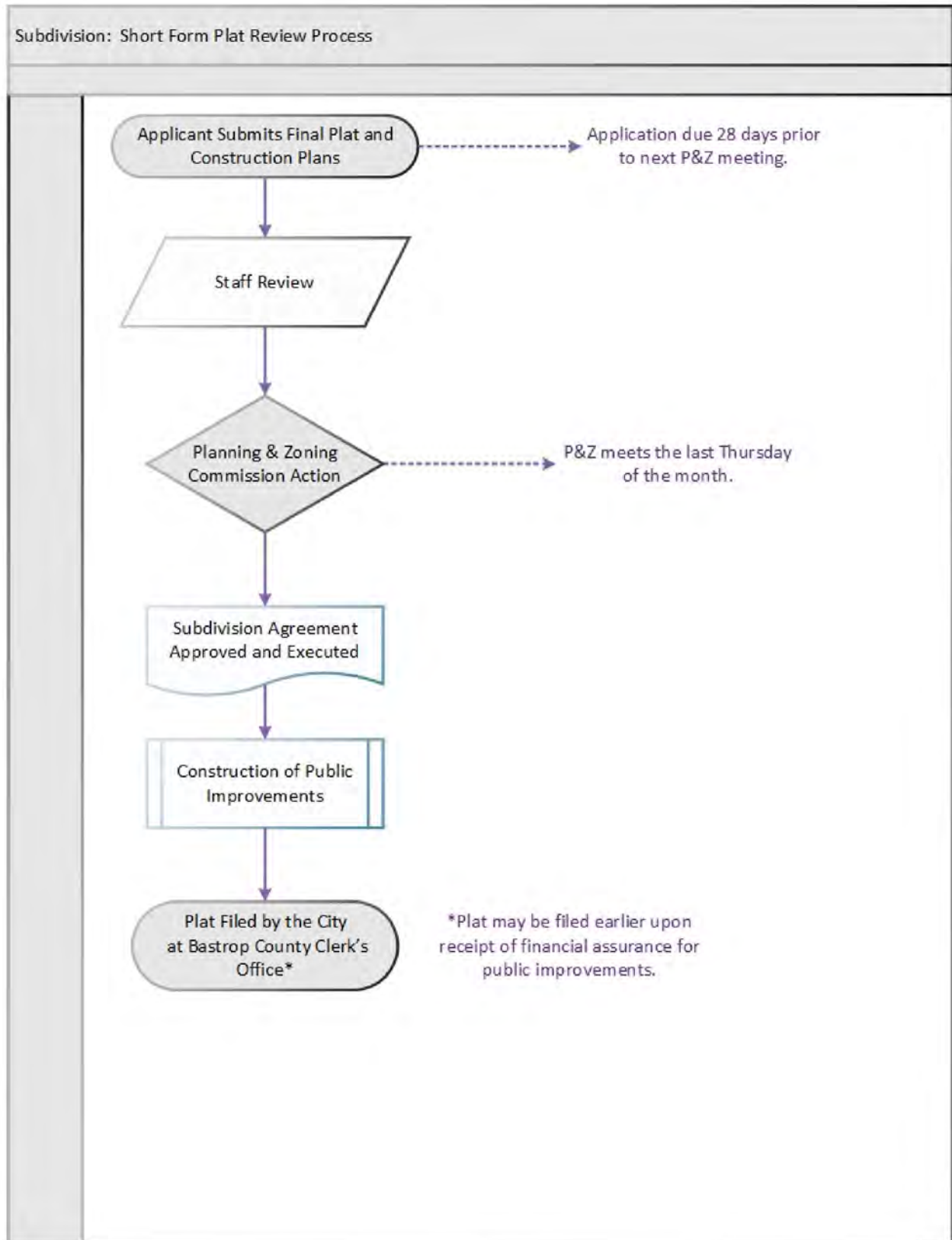

#### 10.16.030 Administrative Process

- A. The Administrative process will be treated the same as the Short Form process, with the exception that final approval is made by the Director of Planning. A summary of the process is shown in Figure 10-4.
- B. Any proposed plat may be removed from the administrative process and placed in either the short form or standard process at the sole discretion of the Director of Planning.
- C. Any applicant aggrieved by a decision or condition imposed by the city staff may appeal to the Planning and Zoning Commission. In such event, the applicant shall file the number of copies required for a preliminary plat, along with a written appeal of the requirement by the city staff.

#### 10.16.035 Replats and Residential Replats

##### A. Replats in general

- 1. The process for replats will be classified as standard, short form, administrative, or residential replats at the time of sketch plat review. Replats designated for the standard, short form or administrative process shall submit according to the requirements for each process outlined above. Processing of a replat shall conform to the requirements of Sections 212.014 and 212.015 of the Texas Local Government Code.

##### B. Residential Replat

- 1. If during the preceding five years, any of the area to be replatted was limited by an interim or permanent zoning classification, to a residential use for not more than two residential units per lot; or any lot in the preceding plat was limited by deed restrictions to a residential use for not more than two residential units per lot, are classified as Residential replats and the notice and voting requirements of Section 212.015, Local Government Code, are applicable and must be followed.
- 2. The process for a residential replat is similar to that for a Short Form Plat, except for the requirement to hold a public hearing in accordance with Local Government Code 212.014. The process is summarized in Figure 10-5.
- 3. The Director of Planning shall provide notice of the hearing required under Texas Local Government Code Section 212.014 before the 15th day before the date of the hearing by:
  - a. publication in the official newspaper; and
  - b. by written notice, with a copy of Subsection (3) below, forwarded by the Director of Planning to the owners of lots that are in the original subdivision and that are within 200 feet of the lots to be replatted, as indicated on the most recently approved municipal tax roll or in the case of a subdivision within the extraterritorial jurisdiction, the most recently approved county tax roll of the property upon which the replat is requested. The written notice may be delivered by depositing the notice, properly addressed with postage prepaid, in a post office or postal depository within the boundaries of the municipality.

#### 10.20.010 FORM AND CONTENT

##### A. Sketch Plat.

- 1. Content. The purpose of the sketch plat is to facilitate review and identify necessary details for inclusion in the preliminary plat. Sketch plat review is intended to accommodate the development of land within a minimum of time and with minimal corrections during the preliminary plat review. The sketch plat may be drawn by computer or in pen or pencil to a convenient scale (preferably one inch is equal to fifty feet) on any size sheet, though it may be useful to the applicant to use one of the following standard sheet sizes: twenty-four inches by thirty-six inches (24" x 36"), eighteen inches by twenty-four inches (18" x 24"), or eleven by seventeen inches (11" by 17") and shall show the following:

Figure 10-4

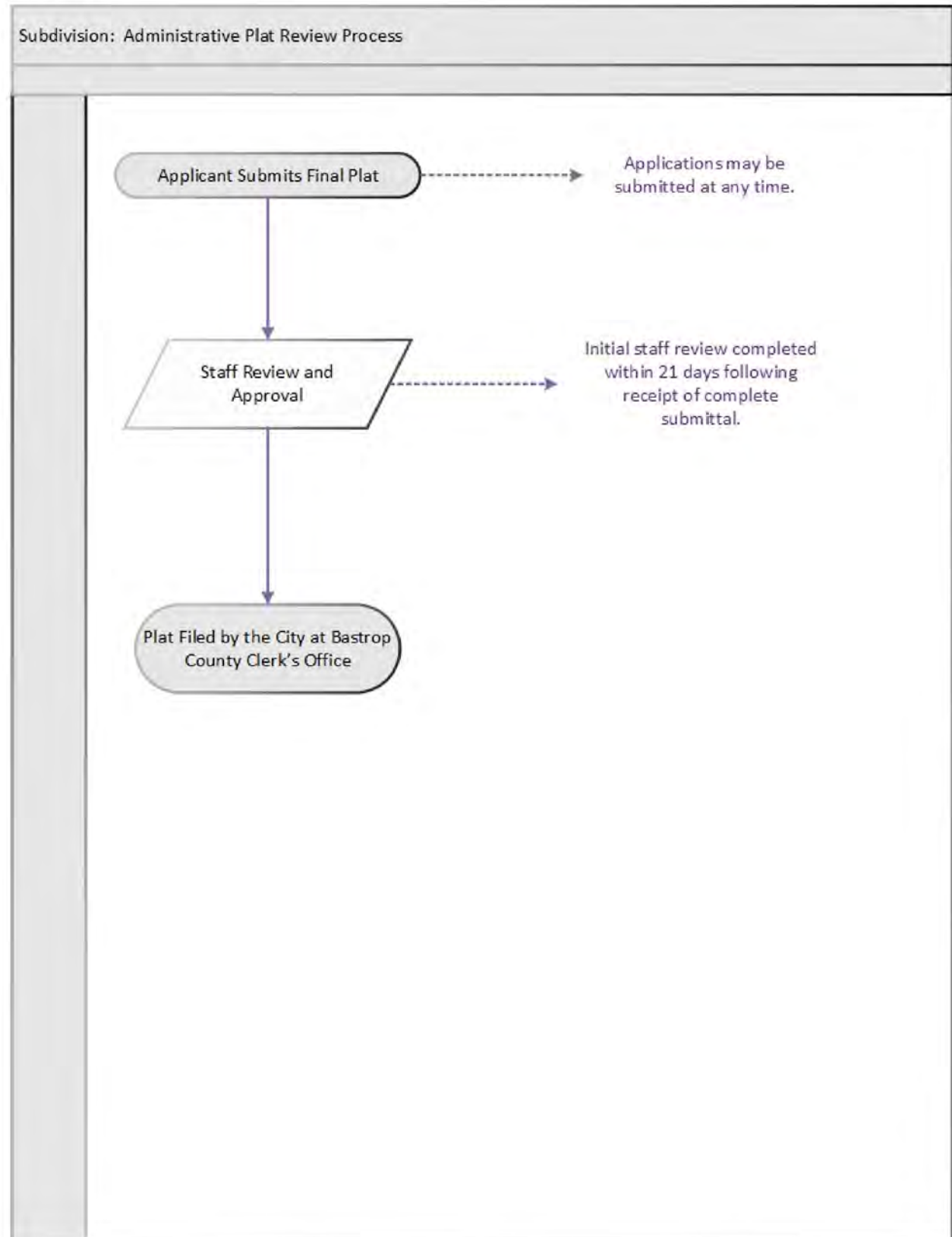
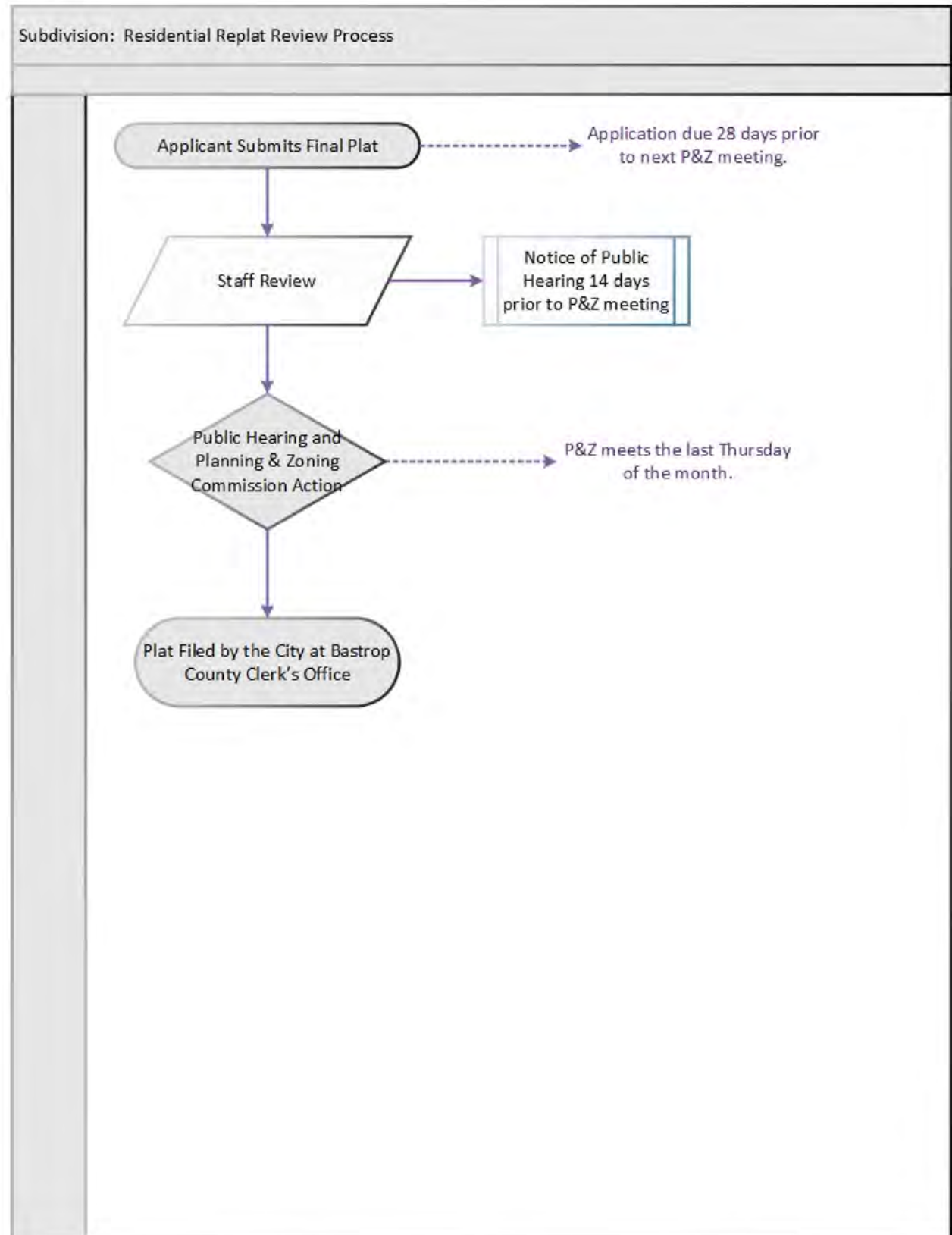

Figure 10-5



- a. Name of the Subdivision:
    - (1) Name of the subdivision if property is within an existing subdivision,
    - (2) Proposed name if not within a previously platted subdivision. The proposed name shall not duplicate the name of any plat previously recorded,
    - (3) Name of property if no subdivision name has been chosen;
  - b. Ownership:
    - (1) Name, address, and telephone number of legal owner of property and agent for owner, if any,
    - (2) Name and address, including telephone number of the surveyor or engineer responsible for preparation of plat submittal;
  - c. Description. Location of property by lot, block, or survey abstract and graphic scale, north arrow and date;
  - d. Features.
    - (1) Location of property lines, existing easements, right-of-way, watercourse, and existing wooded areas; location, width, and names of all existing or platted streets or other public ways within or immediately adjacent to the tract.
    - (2) Location of significant existing sewers, water mains, culverts, and other underground structures within the tract and immediately adjacent thereto; existing permanent buildings on or immediately adjacent to the site and utility rights-of-way.
    - (3) Approximate topography with contours at two-foot (2') intervals suitable to understand general drainage patterns. This may be obtained from previous topographic maps.
    - (4) The approximate location and proposed widths of all proposed street right-of-way and pavement.
    - (5) Preliminary concept for connection with existing water and sewer system
    - (6) Conceptual Drainage Site Plan (as required by Section 10.28.010C) for collecting and discharging surface water drainage.
    - (6) The approximate location, dimensions, and area of all parcels of land to be set aside for park or other public use, or for common use of property owners in the proposed subdivision.
    - (7) The location of temporary stakes to enable the city staff to find and appraise features of the sketch plat in the field if other landmarks are not present.
    - (8) Whenever the sketch plat covers only a part of an applicant's contiguous holdings, the applicant shall submit a sketch of the proposed subdivision area, together with its proposed street system, and an indication of the probable future street and drainage system of the remaining portion of the tract.
    - (9) A vicinity map showing streets and other general development of the surrounding area. The sketch plat shall allow all zoning district boundaries within the adjacent to the tract, and if proposed to be changed from current boundaries.
    - (10) Floodplain limits of the 100-year and 500-year flood, as shown on the current flood insurance rate map.
2. The City Council hereby delegates approval authority as per Local Government Code Section 212.0065 to the Director of Planning.



## B. Preliminary Plat

1. Preliminary Plat Form and Content. The preliminary plat shall be drawn to a scale of one hundred feet to one inch (1" = 100') or larger on a standard sheet size of twenty-four inches by thirty-six inches (24" by 36") or eighteen by twenty-four inches (18" by 24"). An alternate scale may be acceptable upon approval by the Director of Planning. When more than one sheet is necessary to accommodate the entire area, an index sheet showing the entire subdivision at an appropriate scale shall be attached to the plat. The preliminary plat shall show the following:
  - a. Legal description of property to be subdivided including a tie to an original corner of the tract of land of which subdivision is a part.
  - b. Names and addresses of the subdivider, all record owners (and address unless given in letter of transmittal), surveyor and engineer. The telephone number of the developer, or their designated representative, surveyor and engineer shall also be provided. If the owner is a partnership, corporation or other entity other than an individual, the name of the responsible individual such as president or vice-president must be given. The name of the licensed public surveyor and licensed engineer (when required) responsible for preparing the plat.
  - c. Proposed name of the subdivision, which shall not have the same spelling, or be similarly-pronounced, as the name of any other subdivision located within the city or its extraterritorial jurisdiction;
  - d. Names, recording information and lot patterns of contiguous subdivisions and recording information thereof, and description of contiguous parcels of unsubdivided land. The existing lot patterns, streets, and easements within two hundred feet of the proposed subdivision shall be clearly indicated;
  - e. Subdivision boundary lines, indicated by heavy lines, and the computed acreage of the subdivision. The total acreage and the proposal total number of lots and blocks within the subdivision. Ownership boundaries shall be drawn in very heavy lines and shall include overall dimensions and bearings.
  - f. The location, dimensions, name and description of all existing or recorded streets, alleys, reservations, easements or other public rights-of-way within the subdivision, intersecting or contiguous with its boundaries or forming such boundaries; Existing transportation features within the subdivision including the location and width of right-of-way, streets, alleys and easements.
  - g. The location, dimensions, description and name of all existing or recorded residential lots, parks, public areas, permanent structures and other sites within or contiguous with the subdivision; Adjacent boundary lines and adjacent right-of-way lines of the proposed subdivision drawn with dashed lines. Name and location of adjacent subdivisions, streets, easements, pipelines, water courses, etc., and the property lines and name of all adjoining property owners.
  - h. The location, dimensions, descriptions, and flowline of existing water courses and drainage structures within the subdivision or on contiguous tracts;
  - i. The approximate location of the floodway and the one hundred-year (100 yr) and five-hundred-year (500 yr) floodplain and all lots, or any part of a lot, that lies within the floodway or one hundred-year floodplain as shown on the current flood insurance rate map; Regulatory flood elevations and boundaries of flood prone areas, including floodways.
  - j. The location, dimensions, descriptions and names of all proposed streets, alleys, drainage structures, parks, open spaces, natural features to be preserved or other public areas; reservations, easements, or other rights-of-way; and, blocks, lots and other sites within the subdivision; Proposed features including location, right-of-way and pavement

width, surfacing and name of streets; approximate width and depth of all lots; location of building lines, alleys and public utility easements; and schematic plans for drainage, sanitary facilities and utilities.

- k. Date of preparation, graphic scale of plat and north arrow; Scale: one inch equals one hundred feet (1" = 100') or greater. The prior consent of the Director of Planning will be required for use of a smaller scale. North to be at top of sheet if possible. Date, revision block and each revision shall bear a new date.
- l. Topographical information shall include contour lines on a basis of two vertical feet. Topography shall be tied to vertical controlled benchmarks to be noted on the plat; Existing and proposed topographic and planimetric features within the subdivision, including water courses and ravines, high banks, width of existing and proposed easements and any other physical features pertinent to the subdivision. Contour lines at two-foot (2') intervals in terrain with a slope of two percent (2%) or less and five-foot (5') intervals in terrain with slope greater than two percent (2%). A preliminary plan for proposed fills or other structure elevating techniques, levees, channel modifications, and other methods to overcome flood or erosion related hazards.
- m. A number or letter identifying each lot or site and each block;
- n. Front building setback lines on all lots and sites. Side yard building setback lines at street intersections and access and/or drainage easements;
- o. Location of city limits, the outer border of the city's extraterritorial jurisdiction, and zoning district boundaries, if they traverse the subdivision, form part of the boundary of the subdivision or are contiguous to such boundary;
- p. A vicinity map at a small scale which shall show the location of the proposed subdivision within the city, existing subdivisions, streets, parks and public facilities in the general locality of the proposed subdivision. The map shall have a scale and north arrow; Key Map. A key map showing relation of subdivision to well-known streets in all directions to a distance of at least one (1) mile.
- q. If there is no adjacent subdivision, then a map on a small scale must be presented to show the nearest subdivision in all directions, and how the streets, alleys, or highways in the subdivision submitted may connect with those in the nearest subdivision;
- r. Designation of any sites for special uses including churches, sewage disposal plants, water storage/pumping facilities, wells or plants, business, industry or other special land uses. If proposed use is unknown, designate as unrestricted.
- s. Preliminary Drainage Study (three copies). The preliminary plat submittal shall be accompanied by six copies of a preliminary drainage plan prepared in accordance with Section 10.28.010.D., including a preliminary plan of the drainage system, indicating inlet locations, with grade, pipe size and location of points of discharge.
- t. A preliminary water and sewer plan layout (three copies) showing the location and size of existing and proposed water and sanitary sewer lines and proposed fire hydrant locations prepared in accordance with Section 10.28.010.E, including a preliminary plan sheet showing proposed on-site sewage disposal systems, or sanitary sewers with grade, pipe size and location of points of discharge or connection to existing collection lines.
- u. A preliminary street plan and preliminary lot grading plan (three copies) prepared in accordance with Sections 10.28.010.F and 10.28.010.G;
- v. Tree inventory and preliminary tree mitigation calculations (two copies) in accordance with Section 10.36.010.G.2.
- w. A preliminary street tree plan (two copies) showing proposed location and species of street trees in accordance with Section 10.36.030.S.

### C. Final Plat

1. Final Plat Form and Content: The applicant shall submit the final plat drawn by a licensed surveyor. The final plat shall be drawn in ink on mylar or comparable substitute, on sheets eighteen inches by twenty-four inches (18" x 24") or twenty-four inches by thirty-six inches (24" x 36") in accordance with the Bastrop County clerk specifications for recording and to a scale of one inch to one hundred feet (1" = 100') with original seals and signatures. Where more than one sheet is necessary to accommodate the entire area, an index sheet showing the entire subdivision at an appropriate scale shall be attached to the plat. The applicant shall submit two original eight and one-half inches by eleven inches (8½" x 11") or eight-and-one-half inches by fourteen inches (8 1/2" x 14") executed dedication instruments, tax certificates, groundwater availability certificate (if required), suitable for filing with the county along with recording fees required by the county clerk if they are not shown on the face of the plat. The final plat and accompanying data shall conform to the preliminary plat as approved by the commission incorporating all changes, modifications, alterations, corrections and conditions imposed by the commission. The final plat shall comply in all respects with the approved preliminary plat for a standard plat or the approved sketch plat for a minor subdivision, replat or minor plat.
2. Requirements: The following information will be shown on or will accompany the plat:
  - a. Final plats shall contain the name, firm name, address, phone number and registration of the licensed public surveyor responsible for the preparation of the plat, and the name, address, and phone number of the landowner or owners (dedicator);
  - b. Proposed name under which the subdivision is to be recorded. All subdivisions shall be named, and the name approved by the city before the final plat is submitted. No subdivision or street name shall be a duplication, either in part or in whole or be similar in spelling or pronunciation to the name of any other subdivision within the city or within any distance outside the city, which might result in confusion to operators of emergency vehicles;
  - c. The Subdivider wishing to amend or replat property must provide a complete copy of the original plat and a signed written statement stating which features of the plat are to be changed.
  - d. A complete legal description by metes and bounds of the land being subdivided and the tract designation and other description according to the real estate records of the county;
  - e. An accurate on-the-ground boundary survey of the property showing bearing and distances and the lines of all adjacent land, streets, easements and alleys with their names and width. (Streets, alleys and lot lines in adjacent subdivisions shall be shown dashed.) All necessary data to reproduce the plat on the ground must be shown on the plat. Bearing and length or curve data (radius, central angle, chord bearing and distance) of each boundary line shall be shown and description by metes and bounds of the subdivision perimeter shall be placed on the plat. The source of all bearings shall be the Texas State Plane Coordinate System (NAD 1983 State Plane Coordinates-Texas-Central-FIPS-4203-Feet) and shall be noted on the plat. The point of beginning for land in a subdivision described by metes and bounds should be clearly defined on the plat, and any plat shall be clearly related to the survey, tract, or subdivision of which it is a part;
  - f. All distances shown on the final plat shall be horizontal ground lengths. The plat shall state the Texas State Plane Coordinate System combined scale factor that is to be used to convert ground lengths to grid lengths.
  - g. Graphic and written Scale, North Arrow and Date of Preparation and latest revision;
  - h. Subdivision boundary lines of the total area proposed for subdivision and the computed acreage of the total area;

- i. The location, dimensions, description and name of all proposed streets, alleys, drainage structures, parks, other public areas, reservations, easements or other rights-of-way; block, lots, and other sites with complete dimensions for front, rear and side lot lines within the subdivision with accurate dimensions, bearing or deflection angles and radii, arcs, tangents, and central angles of all curves where appropriate;
- j. The location of proposed blocks, lots, and other sites within the proposed subdivision and location of each lot with reference to an original corner of the original subdivision or tract of which said land is a part; A number shall be used to identify each lot, site or block;
- k. The area of each lot, in square feet, and outside dimensions, in feet;
- l. Data specifying the gross area of the subdivision, the proposed number of residential lots and area thereof, and the area in parks and in other nonresidential uses;
- m. Front building setback lines on all lots and sites. Second front yard (exterior) building setback lines at street intersection. For lots facing on curved streets the chord width of the lot at the front building setback line shall be shown; Refer to the zoning regulations for setback dimensions if property is zoned.
- n. The plat shall show the location and width of existing streets, alleys, public utility easements, storm drainage easements and other easements of record. A plat note shall be provided that states the date of the title search and name of the entity conducting the title search used to identify existing easements.
- o. The plat shall show all existing features within the area being amended, replatted or subdivided, such as existing drainage, easements, width of adjacent streets and alleys and existing utility easements.
- p. Name and recording information of contiguous subdivisions, location and identification of contiguous lots, and indication of whether contiguous properties are platted and recorded and names of owners and deed references of all unplatted adjoining properties;
- q. The location of all permanent monuments and control points described as to size and material. Primary control points or descriptions, and ties to such control points to which all dimensions, angles, and bearings shall be referred. Such primary control points shall be either a city-recorded monument or a USGS monument, if such monument is within two thousand feet of the proposed subdivision;
- r. A location map of the proposed subdivision showing existing and proposed streets and thoroughfares covering an area of at least one-half mile outside the proposed subdivision to adequately indicate the location of the subdivision;
- s. Except for residential replats of less than six lots or two acres, whichever is less, Texas State Plane Coordinates (NAD 1983 State Plane Coordinates-Texas-Central-FIPS-4203-Foot) shall be provided for at least two corners of the plat must be shown on the face of the plat. The reference monuments and method of determining the coordinates (such as triangulation of city monuments or global positioning system techniques) shall be provided;
- t. Each proposed street within the subdivision area shall be named and shall conform with names of any existing street of which they may be or become extensions. Extensions of existing streets or roads shall use the name already established. All streets shall be named, and the name approved by the city before the final plat is submitted. Names of new streets shall not duplicate or cause confusion with the names of existing streets, unless the new streets are a continuation of, or in alignment with existing streets, in which case names of existing streets shall be used. Streets shall be named to provide continuity with existing streets;
- u. The location and dimensions of proposed public utilities easements;



development the dedication shall be only for the section approved. An example of such a dedication instrument would read as follows:

STATE OF TEXAS §

§ OWNER'S ACKNOWLEDGMENT AND DEDICATION

COUNTY OF BASTROP§

I (we), (Owners name or corporation name), the undersigned, owner(s) of the land shown on this plat within the area described as follows:

(Metes and Bounds Description of Boundary or description of previously platted lots, including total acreage according to surveyor)

and designated herein as the \_\_\_\_\_ subdivision to the City of Bastrop, Texas, and whose name is subscribed hereto, hereby dedicate to the public in fee simple all streets, alleys, rights-of-way and parks, and dedicate to the public forever all water courses, drains, easements and public places thereon shown for the purpose and consideration therein expressed.

Owner: \_\_\_\_\_ (title)

Date: \_\_\_\_\_

STATE OF TEXAS §

COUNTY OF BASTROP §

BEFORE ME, the undersigned authority, on this day personally appeared \_\_\_\_\_, known to me to be the person whose name is subscribed to the foregoing instrument, and acknowledged to me that he executed the same for the purposes and considerations and in the capacity therein stated.

Given under my hand and seal of office this \_\_\_\_\_ day of \_\_\_\_\_, 20\_\_\_\_.

Notary Public \_\_\_\_\_

\_\_\_\_\_ County

cc. A certificate of approval to be signed by the Planning and Zoning Commission chair and the city secretary shall be shown on the plat. The following certificate shall be placed on the final plat by the subdivider:

CITY OF BASTROP

Approved by Planning and Zoning Commission:

Chair: \_\_\_\_\_

Attested by City Secretary: \_\_\_\_\_

Date of Approval: \_\_\_\_\_

dd. The final plat shall contain the following caption to be located near the lower right-hand corner of the plat below the title block and in accordance with Bastrop County Clerk

requirements, "This plat filed in Instrument No. \_\_\_\_\_ Date \_\_\_\_\_". Final plats shall contain all necessary information and be in prescribed format required for recording with the Bastrop County Clerk.

- ee. A notation on the face of the plat indicating that "Any franchised public utility, including the City of Bastrop and Bastrop Power & Light shall have the right to move and keep moved all or part of any building, fences, trees, shrubs, other growths or improvements which in any way endanger or interfere with the construction, maintenance or efficiency of its respective system on any of the easements shown on the plat. Any franchised public utility including the city of Bastrop, shall have the right at all times of ingress and egress to and from and upon such easements for the purposes of constructing, reconstructing, inspection, patrol, maintaining, and adding to or removing all or part of its respective systems without the necessity at any time of procuring the permission of anyone";
- ff. Public open space easements (P.O.S.E.) shall be indicated on all lots adjoining two intersecting public streets or otherwise affected by the P.O.S.E. Public open space easements shall be indicated on all lots adjoining one public street and an alley and/or an approved private street and shall have minimum dimensions in accordance with Section 10.36.020.D. A notation of restrictions within P.O.S.E.s shall appear on the face of the plat.
- gg. The following full statement of restrictions shall be placed in the dedication instrument of any subdivision plat that contains land designated as part of a one hundred-year (100 yr) floodplain by FEMA:

"Floodplain Restriction

No construction shall be allowed within a floodplain easement unless specifically approved by the City of Bastrop. Where construction is permitted, all finished floor elevations shall be a minimum of two (2) foot above the base flood elevation (100-year flood or one percent probability flood elevation.)

Any existing creeks, lakes, reservoirs, or drainage channels traversing along or across portions of this addition, will remain as an open channel at all times and will be maintained by the individual owners of the lot or lots that are traversed by or adjacent to the drainage courses along or across said lots. The City of Bastrop will not be responsible for the maintenance and operation of said drainage ways or for the control of erosion. Each property owner shall keep the natural drainage channels traversing adjacent to their property clean and free of debris, silt, or any substance which would result in unsanitary conditions and the City shall have the right of ingress and egress for inspection and supervision of maintenance work by the property owner to alleviate any undesirable conditions which may occur. The natural drainage channel, as in the case of all-natural drainage channels, is subject to storm water overflow and natural bank erosion to an extent that cannot be defined definitively. The City of Bastrop shall not be liable for damages of any nature resulting from the occurrence of these natural phenomena, nor resulting from a failure of any structures within the natural drainage channels. The natural drainage channel crossing each lot is shown by the floodplain easement line as shown on the plat."

- hh. A notation shall be placed on the final plat referencing the tree preservation and mitigation plan on file with the City Planning Department.
- ii. A blanket temporary access and construction easement to Bastrop Power & Light shall be filed by separate instrument and noted on the face of the plat. Upon completion of the electric service construction, the blanket easement will be vacated in lieu of a permanent 20-foot-wide easement encompassing the electric service line and equipment.

4. The following sheets must accompany the final plat:
  - a. A list of the proposed restrictive covenants, conditions, and limitations to govern the nature and use of the property being subdivided;
  - b. The Final Plans, Specifications and Cost Estimates required in Section 10.28.010.H.

#### 10.24.010 Processing of Final Plats

- A. Processing of Final Plat. Processing of final plats shall be in accordance with this section, all other development regulations, and all applicable state and federal regulations.
  1. No final plat or replat shall be approved unless it follows the comprehensive plan.
  2. No final plat or final replat will not be accepted for processing if all or any portion of the land area encompassed within the plat is included in or directly affected by any proposed amendment to the comprehensive plan, which has been set for formal presentation to the Planning and Zoning Commission or the city council by placement on a formal agenda.
  3. No final plat or replat shall be accepted for processing if it is determined to be administratively incomplete by the Director of Planning or designee. The application and fees shall be returned to the applicant until the submittal is complete.
  4. A final plat or replat shall not be accepted for processing until all necessary application materials have been submitted and approved by the city. No final plat will be accepted for processing until the developer's agreements with the city are executed, all public improvements plans, specifications and cost estimates have been approved by the Director of Planning, and financial assurance has been provided. Any final plat submitted will be conditionally disapproved until such materials have been accepted.
  5. Upon receipt of the final plat with construction plans and the required application fees, the Director of Planning or designee shall check the plat as to its conformity with the approved preliminary plat or city's comprehensive plan, land use plan, zoning districts, lot size requirements, subdivision and street names and other applicable city standards.
  6. The Director of Planning or designee shall transmit copies of the final plat and construction plans to the City Engineer who will check same for conformity with applicable engineering standards and specifications set forth in this chapter as well as with generally accepted engineering principles when not covered specifically in this chapter. The City Engineer shall submit a written report to the Director of Planning with their suggestions as to modifications, additions, alterations or other matters pertinent to the plat.
  7. The city staff shall act on a plat within thirty days after the date the plat is filed. The plat is considered filed when formal application has been made for approval, all required information including engineering plans have been submitted and the requisite fees paid.
- B. Final Plat Approval. The commission, acting through its chair, shall act on an administratively complete final plat application within thirty days of the date of acceptance of the final plat for processing. In the case of a short form plat, the commission shall act on a final plat. If such plat is not approved, conditionally disapproved or disapproved within thirty days from the date of acceptance, it shall be deemed to have been approved and a certificate, showing such acceptance date and the failure to act thereon within thirty days from such acceptance date, shall on demand be issued by the commission and such certificate shall be in lieu of the endorsement in this chapter required. Final plats meeting all conditions set on the preliminary plat by the Planning and Zoning Commission shall be approved by the city staff. If a final plat contains significant deviation from the approved preliminary plat, Planning and Zoning Commission approval shall be required. The decision of the commission shall be either approval, conditional disapproval, or disapproval of the final plat.
  1. A final plat which meets all applicable requirements of the subdivision ordinance and any conditions of preliminary plat approval shall be approved by the commission by placing thereon the signature of the chair of the commission and the attestation of the city secretary.



Approved final plats and supporting instruments shall be retained by the Director of Planning for recording as hereinafter specified.

2. Conditional disapproval shall constitute lack of approval of a final plat subject to conformity with prescribed conditions but shall constitute approval when such conditions are met and approved by the Director of Planning.
  3. Disapproval signifies rejection in toto of the final plat as submitted. The commission, following final plat disapproval, may permit an applicant to then submit another final plat or reinstate the subdivision approval procedure at another step.
  4. Conditionally disapproved final plats showing satisfaction of the conditions, in as many copies as required by the commission, may be submitted at any time for approval.
  5. If the city fails to act on a plat within the prescribed period, the Director of Planning, on request shall issue a certificate stating the date the plat was filed and that the city failed to act on the plat within the period.
  6. If the final plat is approved, the Director of Planning or designee shall have the approval certificate on the plat executed by the chair of the Planning and Zoning Commission and attested by the city secretary or designee, contingent to the developer paying all development fees, impact fees and assessment charges.
  7. After the final plat have been approved by the city, but before construction of water, sewer, street or drainage improvements are started, the subdivider shall furnish the city with two (2) full size and two (2) half-size sets of the completed detailed plans and specifications.
  8. Upon approval of the final plat and construction plans, the applicant shall submit two mylars and two blue-line or black-line copies of the plat with original seals and signatures and two original signed dedication instruments, tax certificates, groundwater availability certificate (if required), suitable for filing with the county along with recording fees required by the county clerk.
  9. Lot markers shall be installed in accordance with Section 10.28.010.J.
- C. Disapproved Plats: Should the final plat as submitted fail to meet the conditions and requirements of this Ordinance, the Planning and Zoning Commission shall disapprove said plat. If requested by the developer, the Director of Planning will provide a written statement of the reasons for disapproval. In the event of disapproval, the City may withhold all City improvements of whatsoever nature including the furnishing of sewerage facilities and water service from all additions which have not been approved as provided by law and further, permits may not be issued by the building official of the City on any piece of property other than an original or a resubdivided lot in a duly-approved and recorded subdivision. E. If a final plat is disapproved, the Director of Planning, on request of an owner of an affected tract, shall certify the reasons for the action taken on the application.
- D. Appeal Process: Applicants may appeal administrative decisions denying their proposed plat to the City Council by filing a request for such appeal with the Director of Planning on or before the 30th day following the date of administrative denial. The City Council may not approve or disapprove the plat but may remand the plat back to the Planning and Zoning Commission for reconsideration.
- E. Signing of Plat.
1. The chair of the Planning and Zoning Commission and City Secretary shall sign all copies of the approved final plat.
  2. If public improvements are to be installed and a surety required, the chair of the commission shall endorse approval only after the developer's agreement has been approved by the city manager, all fees have been paid, and financial assurance has been posted.
  3. The signature of the chair of the commission indicates approval of the platting of the land, not the improvements to be placed thereon.

F. Recording of Plat.

1. After the final plat has been signed by the chair and attested by the city secretary, the plat will be filed by city staff for recording with the county clerk. It shall be the responsibility of the Director of Planning or designee to record the plat with the county clerk's office. The developer/subdivider shall reimburse the City the actual amount of the filing fee. The final plat shall be recorded by the Director of Planning or designee in the office of the county clerk of Bastrop County within ten days from and after the date of final acceptance.
2. A blackline copy of the approved plat with all signatures shall be returned to the applicant. Additional copies can be provided upon prior arrangement with the Director of Planning or designee.

G. Dormant Final Subdivision Plats

1. Expiration of Dormant Final Plats: City approval of a final subdivision plat expires at the end of two (2) years from the date of City approval, unless:
  - a. the subdivider has completed the necessary public improvements and the City has recorded the final plat in the Bastrop County Plat Records, or
  - b. adequate financial assurance has been posted, the City has recorded the final plat in the County Plat Records, and the City Engineer determines that substantial progress has been made on the construction of public improvements.

The Planning and Zoning Commission may, upon showing of good cause, if written request from the subdivider is received prior to the end of the two-year period, grant an extension for up to one additional year. Only one such extension shall be granted. If any major changes are requested by the subdivider and/or are required by the City, the City may require submission of either a new preliminary and/or a new final plat and any dormant final plat that has been filed will be vacated.

10.28.010 - Engineering Plans and Standard Specifications for Public Works Construction

A. Requirement for Engineering License in State of Texas

The subdivider shall retain the services of an Engineer, licensed in the State of Texas, whose seal shall be placed on each sheet of the drawings, and who shall be responsible for the design and inspection of the drainage, roads and streets and sewer and water facilities within the subdivision. The services performed by the Engineer shall be designated in the most current issue of "Manual of Professional Practice - General Engineering Service," published by the Texas Society of Professional Engineers, and shall include both design and inspection as defined therein.

- B. Plans and Specifications: Prior to approval of the final plat by the City Council, two (2) sets of plans and specifications prepared by a licensed Engineer shall be submitted to the City for review and approval. The plans and specifications shall cover the construction of water and sewer lines, street and drainage improvements. Plans for proposed sewer, street and drainage improvements shall be on plan profile sheets. Such plans and specifications shall be reviewed by the City Engineer and shall have the approval of the City Council prior to the approval of the final plat and the beginning of any construction, after which the City shall issue a notice to proceed in accordance with paragraph 10.32.020.G. The specifications document shall be a separate document supplied with each set of plans. These specifications shall be in accordance with the current City of Bastrop Standard Specifications as approved by the City Council.

C. Conceptual drainage site plan.

The conceptual drainage site plan shall be submitted at the time of sketch plat submittal at the same scale as the sketch plat, preferably one inch is equal to fifty feet (1"=50') and shall include:

1. Project Description.
    - a. Address and legal description of site.
    - b. Vicinity map.
    - c. Land use.
  2. Existing Conditions.
    - a. Copy of applicable digital orthophotos showing the proposed project boundaries;
    - b. A topographic map of existing site conditions (no greater than two-foot (2') contour interval) with drainage basin boundaries indicated and project boundaries shown at the same scale as the Sketch Plat;
  3. Total area size of development (in acres);
  4. Total impervious area as a percentage (%) of total area;
  5. Benchmarks used for site control;
  6. Perennial and intermittent streams;
  7. Map of predominant soils from USDA soil surveys;
  8. Boundaries of existing predominant vegetation;
  9. Location and boundaries of other natural feature protection and conservation areas, such as wetlands, lakes, ponds, floodplains, stream buffers and other setbacks (e.g., drinking water well setbacks, septic setbacks, etc.);
  10. Location of existing roads, buildings, parking areas and other impervious surfaces;
  11. Existing utilities (e.g., water, sewer, gas, electric) and easements;
  12. Location of existing drainage conveyance systems such as grass channels, swales, and storm drains;
  13. Flow paths;
  14. Location of floodplain/floodway limits and relationship of site to upstream and downstream properties and drainage systems;
  15. Location and dimensions of existing channels, bridges or culvert crossings.
- D. Conceptual Site Layout.
1. Completed drainage Conceptual Plan Worksheet as provided by the City Engineer.
  2. Hydrologic analysis to determine conceptual runoff rates, volumes, and velocities to support selection of stormwater controls.
  3. Conceptual site design identifying integrated site design practices used.
  4. Identification of stormwater site design credits.
  5. Identification and calculation of water quality volume reduction, if applicable.
  6. Conceptual estimates of the three-storm design approach requirements (i.e. 1-year, 25-year and 100-year 24-hour storms)
  7. Conceptual selection, location and size of proposed structural stormwater controls.
  8. Conceptual limits of proposed grading and clearing.
  9. Total proposed impervious area, as a percentage of total area.

#### D. Preliminary drainage site plan.

For a standard plat, this sheet shall be submitted with the preliminary plat and shall be at the same scale as the preliminary plat. For a minor plat, this sheet shall be submitted with the final plat. The preliminary drainage site plan should consist of maps, narrative, and supporting design calculations (hydrologic and hydraulic) for the proposed stormwater management system. The scale of supplementary plans, profiles and cross-sections shall be sufficient to clearly show details, if required to demonstrate the adequacy of existing or proposed facilities. The Preliminary Drainage Plan shall include the following sections:

1. Existing Conditions Hydrologic Analysis. Provide an existing condition hydrologic analysis for stormwater runoff rates, volumes, and velocities which includes:
  - a. Existing conditions data developed in the conceptual drainage site plan;
  - b. All existing stormwater conveyances and structural control facilities;
  - c. Direction of flow and exits from the site;
  - d. Analysis of runoff provided by off-site areas upstream of the project site;
  - e. Methodologies, assumptions, site parameters and supporting design calculations used in analyzing the existing conditions site hydrology.
2. Project Description and Design Considerations. Provide an updated description of the project and the considerations and factors affecting the design approach that have changed between the conceptual and preliminary plans, including:
  - a. A description of the overall project and the site plan showing facility locations, roadways, etc.;
  - b. A discussion of the applicable local criteria and how it will be integrated into the design of the project;
  - c. Evaluate the integrated site design practices and their applicability to this site;
  - d. A discussion of any credits for integrated site design being requested;
  - e. A discussion of the water quality treatment techniques (pollution prevention practices) that are to be utilized on this site, if applicable;
  - f. A determination of groundwater recharge considerations, if applicable, for this site;
  - g. Identify hotspot land uses, if applicable, and how runoff will be addressed.
3. Post-Development Hydrologic Analysis. Provide a post-development hydrologic analysis for stormwater runoff rates, volumes, and velocities, which includes:
  - a. A topographic map of developed site conditions (minimum two-foot (2') contour interval recommended) with post development basin boundaries indicated;
  - b. Total area of post development impervious surfaces and other land cover areas for each subbasin affected by the project;
  - c. Runoff calculation for flood control and streambank protection for each subbasin, as well as any applicable water quality calculations;
  - d. Location and boundaries of proposed natural feature protection and conservation areas;
  - e. Documentation and calculations for any applicable site design credits or water quality volume reduction methods being used;
  - f. Methodologies, assumptions, site parameters and supporting design calculations used in analyzing the post-development conditions site hydrology;

- g. Supporting documentation that there is existing streambank protection/reinforcement or that the planned development will provide streambank protection downstream;
- h. Supporting calculations for a downstream peak flow analysis to show safe passage of post-development design flows downstream. Document point downstream at which analysis ends, and how it was determined.
- i. Where a lot is located adjacent to a major drainage course or overflow channel, such that a part of all of the lot lies within the regulatory 100-year flood boundary, the drainage plan shall show proposed building sites and elevations required to put finish floor a minimum of one foot (1') above the 100-year flood level of drainage course or overflow channel as stipulated in the City of Bastrop's Flood Damage Prevention Regulations, as periodically amended.

In calculating runoff volumes and discharge rates, consideration may need to be given to any planned future upstream land use changes. Depending on the site characteristics and given local design criteria, upstream lands may need to be modeled as "existing conditions" of "projected buildout/future condition" when sizing and designing on-site conveyances and stormwater controls.

4. Stormwater Management System Design. Provide drawings and design calculations for the proposed stormwater management system, including:
  - a. A drawing or sketch of the stormwater management system including the location of nonstructural site design features and the placement of existing and proposed structural stormwater controls. This drawing should show design water surface elevations, storage volumes available from zero to maximum head, location of inlets and outlets, location of bypass and discharge systems, and all orifice/restrictor sizes;
  - b. Narrative describing that appropriate and effective structural stormwater controls have been selected;
  - c. Cross-section and profile drawings and design details for each of the structural stormwater controls in the system. This should include supporting calculations to show that the facility is designed to the applicable design criteria;
  - d. Hydrologic and hydraulic analysis of the stormwater management system for all applicable design storms (should include stage-storage or outlet rating curves, and inflow and outflow hydrographs);
  - e. Documentation and supporting calculations to show that the storm water management system adequately meets the integrated design approach (see iSWM™ Technical Manual)
  - f. Drawings, design calculations and elevations for all existing and proposed stormwater conveyance elements including stormwater drains, pipes, culverts, catch basins, channels, swales and areas of overland flow.
5. Plans shall show storm (flood) water routing and all drainage structures with sizes of culverts, retarding and retaining structures, drainage easements with course and distance of centerline and boundaries, lot lines, street layout, proposed inlets, culverts, roadside swales, channel sections and slopes, bridges, channel improvements, levees, or berms, fills necessary to elevate land above flood levels, and remove same from the flood area.
6. The limits of the 100-year frequency storm watershed area shall be shown for all water ways, including overflow of structures and related backwater effects. Storm water runoff resulting from a design storm of 100-year frequency shall be contained within the available right-of-way and/or drainage easement. All drainage facilities must be designed for a capacity to safely contain storm water from a design storm of 25-year frequency and sufficient right-of-way and drainage easements to accommodate the 100-year frequency.

- 7 The drainage plan shall be prepared by a Licensed Professional Engineer of the State of Texas, whose seal and signature shall appear on the plan.
8. Engineering drainage report to support all drainage designs shall be submitted to the City. Computations shall be complete and orderly and shall clearly state all assumptions and design basis.
9. Profiles, cross-sections, or substantiating data may be required at the City's request as necessary to support flood levels and backwater analysis.

E. Preliminary water and sewer plan.

This sheet shall be submitted with the preliminary plat for standard plats in a form acceptable to the Bastrop City Engineer. It shall be prepared from the preliminary plat, but shall also include topographical contours at the intervals specified for preliminary drainage plan, and show the following:

1. Existing sewers, water mains, gas mains, electric and telephone lines, culverts, or other underground structures or utilities within the tract and immediately adjacent thereto with pipe sizes, grades, and locations indicated;
2. Indicate the direction and distance to, and size of the nearest water mains and sewers in the event they are not on or adjacent to the tract, showing invert elevation of sewers, if any;
3. The size and location of all proposed sewer mains and proposed easements, if required, including manholes. Preliminary sewer plans are required to determine location of easements;
4. The size and location of all proposed water distribution mains including valves and fire hydrants;
5. The size of water mains according to requirements of the Bastrop City Engineer.

In the event water mains and sewers are not on or adjacent to the tract, indicate the direction and distance to, and size of the nearest ones, showing invert elevation of sewers.

F. Preliminary street plan.

This sheet shall be submitted with the preliminary plat for standard plats and shall be prepared from the preliminary plat, showing topographical contours as applicable, and showing the following:

1. Type of street to be constructed (i.e., concrete);
2. Classification (i.e., arterial, collector, local);
3. Additional easement or right-of-way requirements;
4. Design standards used;
5. Relationship of existing and planned streets, to topographical conditions, if applicable.

G. Preliminary lot grading plan.

This sheet shall be submitted with the preliminary plat for standard plats and shall be prepared from the preliminary plat, showing topographical contours as applicable, and showing the following:

1. Planned grading contours, elevations, earth works, slopes, retaining walls, or other grading information if required by the City Engineer.

#### H. Final Construction plans for public improvements.

These plans shall be submitted with the final plat for standard plats, and for minor plats with infrastructure when required.

1. General Requirements. Prior to the commencement of any construction of public works improvements, the developer or person who intends to construct such projects shall present plans, specifications, and projections of probable cost setting forth in detail all elements of construction to the city for approval. In the case of public improvements associated with subdivision development, the engineering plans (including descriptions of all necessary off-site easements) must be approved in accordance with all requirements of the subdivision ordinance prior to approval of the final plat.
  - a. Four (4) copies (plus one electronic copy) of complete plans, specifications, engineering calculations, and detailed cost estimates for streets, drainage, sanitary sewers, water distribution, and any other improvements to be performed, with the engineer's seal affixed, are required for submission at final plat approval. Upon approval, two (2) full-size and two (2) half-size copies of the construction plans shall be submitted.
  - b. Final drainage site plan, including the construction stormwater pollution prevention plan (SWPPP), landscaping plan, operations and maintenance plan, and evidence of acquisition of applicable federal, state and local permits.
  - c. These plans shall be submitted on standard eighteen by twenty-four-inch (18" by 24") or twenty-four by thirty-six-inch (24" by 36") sheets for full-size sheets and eleven by seventeen inch (11" by 17") for half-size sheets and shall include the information required in this chapter. Plan and profile sheets shall be oriented with the plan view at the top portion of the sheet.
  - d. Each plan shall show the seal and signature of the registered professional engineer who prepared the plan. The subdivider shall retain a registered civil engineer, licensed to practice in the state of Texas, for all design in new subdivisions or developments, including streets, storm drains, water and sanitary sewers.
  - e. Upon approval of the plans, the developer shall furnish two full-size and two half-size sets of final approved plans to the city planner or designee for the developer's agreement.
2. Content of Plans, Specifications and Cost Estimates.
  - a. The plans shall include plan view, profile and section views of the proposed improvements. Construction details of all structures and appurtenances including dimensions, reinforcing, and components such as grate and manhole covers shall be shown. The proposed curb and gutter type and location in relation to the center line and right-of-way, the proposed sidewalk dimension and the proposed parkway grading shall be shown on street plans. This information shall be given for each of the different types of streets and alleys in the subdivision. Soils test by an approved soil testing laboratory shall be submitted with the plans to determine the limits and amount of lime or cement stabilization required.
  - b. The plans shall include the alignment of each street, alley, crosswalk and drainage and any other easement, and a beginning and end station of the point of intersection of each curve. The station and angle of each intersection with another street, alley, or drainage easement, the station and radius of each curb return, the location of all monuments and the length, width, thickness of base, subgrade and surface material of each street.
  - c. The plans shall also include the location, description and elevation of all benchmarks, the direction of storm drainage flow at each intersection, the flowline elevation of each drainage structure, the flowline elevation of each storm sewer at each point of change of grade and each end and the intervening gradient, the profiles of streets, alleys, and drainage structures shall show the natural ground at adjacent property lines and the proposed center line.

- d. The plans and profiles should be drawn at a scale of one inch to forty feet (1"=40') horizontal and one inch to four feet (1"=4') vertical on sheets no larger than twenty-four inches by thirty-six inches (24" by 36") in size. North arrow and date of preparation must be shown on each sheet. All public work improvement plans shall bear the seal and signature of a professional engineer registered in the state of Texas.
  - e. The applicant shall include on the plans all calculations and assumptions used in the design of the proposed improvements. Calculations shown on the plans will not have to be repeated in a report.
  - f. Cost projections shall be prepared using quantities shown on the construction plans and recent unit prices from bids on similar projects. Reasonable contingencies should be included to cover uncertainty in the projection. Actual bids supported by bid and performance bonds may be used in lieu of projections of probable cost.
  - g. Upon approval of the construction plans, specifications and projections of probable cost by the City Engineer; approval of the contract documents, bonds and financial assurance; acquisition of all necessary off-site easements, and upon receipt of the inspection fees, TCEQ notice of intent (NOI), stormwater pollution prevention plan, and conformance with all requirements of and approval by the Bastrop, the city shall schedule a pre-construction conference and issue a permit for the construction of public works improvements.
3. Final Drainage Plans. Upon approval of the preliminary drainage study, the developer shall submit detailed plans, specifications and cost projections prepared by a registered professional engineer registered in the State of Texas and experienced in municipal drainage work. Existing and proposed flow lines of all improvements shall be shown. Unless otherwise specified herein, drainage requirements shall be based on the ISWM™ Criteria Manual for Site Development and Construction. The Hydraulic Manual prepared and compiled by the Texas Department of Transportation Bridge Division, with current revisions, may be used in cases not covered by the iSWM Design Manual for Site Development. The following shall be included in the Plans:
- a. Final drainage site plan, which includes all the revised elements included in the preliminary drainage site plan, plus a construction stormwater pollution prevention plan (SWPPP), a landscaping plan, operations and maintenance plan, evidence of acquisition of applicable federal and state permits, and any waiver requests.
    - (1) Existing and proposed topographic information, with minimum two-foot contour intervals.
    - (2) Location map.
    - (3) Off-site and on-site drainage area maps.
    - (4) Centerline of watercourses.
    - (5) Regulatory flood elevations and boundaries of flood prone areas, including Floodways where designated.
    - (6) Drainage easements.
    - (7) All street widths and grades.
    - (8) Calculations showing the anticipated stormwater flow, including watershed area, runoff coefficient, and time of concentration. When a drainage structure or storm sewer is proposed, calculations shall be submitted showing basis for design.
    - (9) Storm sewer plans and profiles showing size, grade, and pipe or culvert material. Runoff, inlet, conduit hydraulic grade line calculations are required.
  - b. Final grading and drainage construction plans, indicating two-foot contours. All street width and grades shall be indicated on the plan, and runoff figures shall be indicated on



the outlet and inlet side of all drainage ditches and storm sewers, and at all points in the street at changes of grade or where the water enters another street or storm sewer or drainage ditch. Drainage easements shall be indicated. A grading plan shall be prepared for each subdivision and show in sufficient detail grading of all roads, streets, drainage structures, channels, swales, or other drainage related features and provide minimum finished floor elevations, based on an acceptable elevation datum, for proposed structures to assure no inundation of such structures by the rainfall runoff by a one hundred (100) year frequency storm.

- c. When a drainage channel or storm sewer is proposed, complete plans, profiles and specifications shall be submitted showing complete construction details. Scales shall be one inch equals to forty or fifty feet (1" = 40' or 50') horizontally and one inch equal four or five feet (1" = 4' or 5') vertically.
  - d. Two (2) copies of detailed cost estimates.
  - e. A plan of the development shall be submitted depicting the final grading contours and elevations, earthwork, slopes, retaining walls, minimum finished floor elevations of all affected structures, and any other information considered necessary by the City Engineer at a scale of one inch is equal to one hundred feet (1" = 100') minimum.
  - f. Complete detention pond plans and calculations meeting the requirements of Section 10.36.060.B.8.f.j].
  - g. All drainage calculations are required to be present on the plans or in an engineering report signed and sealed by an engineer licensed in the State of Texas. Computations shall be complete and orderly and shall clearly state all assumptions and design basis.
4. Final Water and Sewer Plans.
- a. The final water and sewer plans shall be submitted in accordance with the policies and procedures of the City of Bastrop. Three copies shall be submitted to the city. These plans shall be submitted with the final plat for standard plats and shall be prepared from the preliminary plat, but shall also include topographical contours and shall show the following:
    - (1) Existing sewers, water mains, gas mains, electric and telephone lines, culverts, or other underground structures or utilities within the tract and immediately adjacent thereto with pipe sizes, grades, and locations indicated;
    - (2) A plan and profile of proposed sanitary sewers, with grades and pipe sizes indicated and showing locations of manholes, cleanouts, etc., and a plan of the proposed water distribution system showing pipe sizes and location of valves, fire hydrants, and fittings, etc., in conformance with the criteria as shown in the part of the ordinance listed as "Design Provisions." Each plan shall show the seal and signature of the registered professional civil engineer who prepared the plans. Each sheet shall include north point, scale, date, and benchmark description to sea level datum. If the applicant does not propose to install a sewage collection system, a preliminary sewage collection plan may be required, suitable for determination of easement requirements;
    - (3) Indicate the direction and distance to, and size of the nearest water mains and sewers in the event they are not on or adjacent to the tract, showing invert elevation of sewers, if any;
    - (4) A plan and profile of the proposed water distribution system showing pipe sizes and location of valves, fire hydrants, and fittings and other facilities. A profile is required for all water lines twelve inches in diameter and larger. Each sheet shall include north point, scale, date, and benchmark description to sea level datum;
    - (5) The size and location of all proposed water distribution mains including valves and fire hydrants;

- (6) The size of water mains according to requirements of the Bastrop City Engineer;
- (7) Scales shall be one inch equal to forty or fifty feet (1" = 40' or 1" = 50") horizontally and one inch equals four, five, or ten feet (1" = 4', 1" = 5', or 1" = 10') vertically.
- b. If water and/or sewer services are to be provided by a public corporation or district established under Texas law to provide such services, a written statement shall be required from the authorized officials of the corporation or district to the effect that sufficient water and/or sewage capacity is available for all future subdivision residents and that satisfactory fiscal arrangements have been made with the corporation or district for construction of the facilities in the subdivision by the subdivider.
- c. If water and/or sewer services by a private supply and/or collection and disposal system have been authorized by the Texas Commission on Environmental Quality, the subdivider shall submit copies of all pertinent authorizing documents including copies of any plans and specifications required by the TCEQ) in their approval and shall also submit detailed information relating to the plans for continuous operation and maintenance of the proposed supply and/or collection and disposal system.
- d. Where water and/or sewer distribution facilities are to be provided by the developer and are to be located within the street right-of-way or within public utility or drainage easements, the subdivider shall submit three (3) copies of detailed construction plans and specifications for all such facilities, including pipe size, grade, location, invert elevation, water mains, valves, hydrants, manholes, installation details and other features.
- e. Where subdivisions are proposed that utilize on-site sewage facilities (OSSFs) for sewage disposal, planning material for such systems must be submitted with the Preliminary Plat for review and approval by both the City and County Health and Sanitation official.

The planning materials must be shown on the overall site plan, and include topographic map, 100-year flood plain map, soil survey, location of water wells, and complete report detailing the types of OSSFs to be considered and their compatibility with area wide drainage and ground water. A comprehensive drainage and 100-year flood plain impact plan must also be included in these planning materials. Planning materials shall also address potential replacement areas for OSSF.

All OSSFs shall be located outside the limits of the 100-year flood plain and any drainage easements. All OSSFs shall be designed and constructed in strict compliance with Chapter 285 Rules and Policy to OSSF as established by the Texas Commission on Environmental Quality (TCEQ) or such other more restrictive rules established by Bastrop County.

- 4. Final Street Paving Plans. Final street paving plans shall include:
  - a. A plan and profile of each street with centerline and top curb grades, existing and proposed ground line shown. Each sheet shall include north point, scale, date, and a minimum of two benchmark descriptions to sea level datum. The plans shall include:
    - (1) Type of street to be constructed (i.e., Portland cement),
    - (2) Classification (i.e., arterial, collector, residential),
    - (3) Additional easement or right-of-way requirements,
    - (4) Design standards used,
    - (5) Relationship of existing and planned streets, to topographical conditions, if applicable,

- (6) Planned grading contours, elevations, earth works, slopes, retaining walls, flow arrows or other grading information required by the City Engineer;
- b. Scales shall be one inch equal to forty or fifty feet horizontally and one inch equals four or five feet vertically;
- c. The typical cross-section of proposed streets showing the width of roadways and type of surface, reinforcing, subgrade, sidewalks, curb height, crown height and cut/fill slopes shall be shown;
- d. All other requirements of the current street standards shall be included in the plans;
- e. The plans shall contain a statement of "Released for Construction" for signature of the City Engineer;
- f. Two copies of detailed cost estimates.

5. Other utilities.

The subdivider must furnish a written statement to the city designating how the subdivision will be served by electrical, natural gas, telephone and cable television. Utility construction shall be coordinated with street construction to avoid unnecessary pavement cuts.

6. Design summary.

The City Engineer may require a separate document or report entitled "Engineering Report" that shall be submitted with final plans and specifications. This report shall summarize calculations and other engineering information pertaining to the major items of design significance as may be necessary in the city's review of the plans and specifications to determine whether the facilities proposed for construction have been designed in accordance with the intent of the design standards contained or referenced in this chapter. Calculations should include drainage facilities, water demand, sewage flows, pavement designs and any others that are considered necessary by the city.

I. Standard specifications for public works construction.

Unless otherwise specified herein, the City of Bastrop, Texas, has adopted the Standard Specifications Manual for the City of Austin, as revised through May 31, 2017, plus any local amendments adopted by the City of Bastrop, for use in specifying materials and methods for public works or facilities construction within the City of Bastrop and its extraterritorial jurisdiction. These specifications are adopted in their entirety except as may be amended in the local amendments that are included in the Bastrop Design Standards and Criteria. All builders, developers, and contractors shall use said specifications in the construction materials and methods of any public facilities or projects which are anticipated to be dedicated to, accepted by, or utilized by the public within the City of Bastrop and its extraterritorial jurisdiction. To the extent that any of the provisions of these standard specifications conflict with any other City ordinances, the most restrictive or exacting standard shall apply.

J. Monumentation and benchmarks.

The boundaries of any subdivision presented for review and recording shall be monumented and such monuments shall be noted on the plat and within the accompanying dedication instrument according to Rule 663.11 of the Texas Board of Land Surveying (Certification and Monumentation of Surveys). In no case shall a boundary course of the subdivision be monumented in intervals greater than one thousand three hundred feet. After installation of utilities and pavements, all lot corners, curve points, and changes in course in any line with the subdivision shall be monumented in accordance with the Board of Land Surveying Rule 663.11 by the platting surveyor under the sponsorship of the developer.

- 1. All monuments shall be of materials recognizable as being those of property boundary monuments by professional surveying standards and shall be of sufficient length and girth

and placed in locations sufficiently stable to withstand abuse of normal conditions with significant movement.

- a. Under most circumstances no steel rods smaller than two inches in diameter and shorter than thirteen inches in length should be used nor should pipes smaller than two inches inside diameter and shorter than thirteen inches in length be used.
  - b. No monument made of a wood material shall be used.
2. A minimum of three elevation benchmarks shall be installed in all standard plats reflecting elevation using North American Datum of 1983 (in feet). The city may require the installation of fewer benchmarks in small projects or additional benchmarks in unusually large or complex sites.

K. Erosion and sedimentation control.

Stormwater pollution prevention plans shall be submitted for review by the City Engineer prior to release of construction projects. The developer and their engineer shall be responsible for preparation of a stormwater pollution prevention plan (SWPPP) in accordance with the Texas Commission on Environmental Quality (TCEQ) and U.S. Environmental Protection Agency (EPA) requirements. TCEQ and EPA permitting shall also be the responsibility of the developer and their engineer.

10.32.020 Developer's Agreement, Financial Assurance and Construction Contracts for Public Improvements

A. Procedures.

1. Contract Required. The developer shall be required to execute a developer's agreement as a condition of plat approval whenever the installation of community facilities or public improvements is required. The city shall prepare the developer's agreement after the final engineering plans and cost estimates have been approved. Samples of developer's agreements and bond instruments are available upon request.
2. Approval of Contract.
  - a. After the contract has been signed by the developer and the required performance bond, payment bond, or surety, and maintenance bonds meeting the requirements of Texas Government Code, Chapter 2753, Title 10, Section F have been posted with the city, the city planner may forward the developer's agreement to the City Attorney for review and approval.
  - b. The city manager shall review and sign the contract on behalf of the city after receiving comments of the Director of Planning, City Engineer and City Attorney.
  - c. If any special provisions or deviations from established policies are included in the contract, specific approval of the special provisions or deviations by the City Manager is required.
  - d. No construction work shall begin on the subdivision before the developer's agreement is approved and signed by the City Manager.
  - e. The city will use its best effort to expedite all necessary instruments and documents within the city administration.
3. Changes in Contract. Any subsequent changes in the plans and specifications of the approved project proposed by the developer shall necessitate an amendment to the developer's agreement and amendments to all required financial assurance instruments. An increase in the project scope shall also require an increase in the inspection fee, as authorized in Section 16.24.015(A) of this chapter. The developer shall bear the full cost of any additional work required by the City Attorney and/or City Engineer in revising and/or

reviewing the revised documents and approval shall not be granted until such additional fees are paid.

B. Performance bonds, payment bonds and maintenance bonds.

1. Performance bonds or sureties in forms provided by the City Attorney meeting the requirements of Texas Government Code, Chapter 2253, Title 10, Section F shall be required for any required public improvements or community facilities prior to the filing of the final plat and issuing of any building permits. Bonds, certificates of deposit or cash deposits will be for one hundred percent of the value, as determined by the City Engineer, of the construction costs of all facilities to be constructed by the developer.
  - a. A cash deposit may be made with the city in lieu of the performance bond. The cash deposit shall be held by the city in a regular insured savings account and shall accrue interest at the current regular savings account rate of interest. Interest shall accrue in the account to the benefit of the subdivider and shall be returned to the developer with the cash deposit upon satisfactory completion of the facilities and acceptance by the city.
  - b. A certificate of deposit issued by any financial institution, which is insured by the Federal Deposit Insurance Corporation or Federal Savings and Loan Insurance Corporation, shall be held in the city depository in lieu of the performance bond. When this option is exercised the subdivider shall execute four copies of a letter (approved by the city) assigning the deposit to the city and providing for the city to withdraw the deposit if necessary to complete construction. Such letter of assignment must be accepted in writing by the financial institution. Upon satisfactory completion of the facilities for which the deposit is made as security, the city of Bastrop shall reassign the deposit to the developer including accrued interest or dividends thereon.
2. The developer shall provide a payment bond meeting the requirements of Texas Government Code, Chapter 2253, Title 10, Section F guaranteeing the full and proper protection of all claimants supplying labor and material in the prosecution of the work provided in the contract in an amount equal to one hundred percent of the value of the construction costs of all facilities to be constructed by the developer. The same conditions shall prevail as under subsection (A)(1), (2), or (3) above when certificates of deposit or cash deposits are used instead of surety company bonds.
3. The developer shall provide a maintenance bond meeting the requirements of Texas Government Code, Chapter 2253, Title 10, Section F guaranteeing and agreeing to pay any necessary maintenance for a period of two years in an amount equal to one hundred percent of the value of the construction costs of all facilities to be constructed by the developer. The same conditions shall prevail as under subsection (A)(1), (2), or (3) above when certificates of deposit or cash deposits are used instead of surety company bonds.
4. If work is not completed by the end of the bond period, the developer shall provide additional performance, payment and maintenance bonds as appropriate, or the City will request that the bond issuer complete the project or relinquish funds to the City to complete the project approximately thirty days prior to the expiration of the bonds.

C. Inspections and approval of public improvements.

1. The city council shall establish fees for the inspection of public improvements as part of the fee schedule. No person shall be granted notice to proceed to construct, reconstruct, cut or repair any street, drainage or sanitary sewer facility without paying the fees for the inspection of such work.
2. The developer's contractor shall give at least twenty-four-hours' notice in writing to the City Engineer of their intent to commence actual construction of the facilities for inspection personnel to be made available.

3. The subdivider shall delay connection of buildings to service lines of sewer and water mains until such sewer and water mains and service lines have been completed and accepted by the city.
4. It shall be the duty of the subdivider to notify all contractors and subcontractors working for him that all their work is subject to inspection by the city inspector at any time. Certification of materials being used may be required by the city inspector.
5. Laboratory tests required by the city inspector shall be performed by approved independent testing laboratories and will be at the discretion of the city inspector. Approved laboratories are laboratories that are members of the American Council of Independent Laboratories and shall comply with standard recommended practice for inspection and testing agencies for concrete, steel, and bituminous materials as used in construction, ASTM Designation E 329. All costs for laboratory tests shall be borne by the subdivider or their contractor.
6. Should any point not be covered in the plans, or developer's agreement, the subdivider shall be required to contact the City Engineer for a determination as to the city's requirements.
7. Any work, which in the opinion of the city inspector does not meet the city requirements or has not had proper city inspection, shall be corrected. The inspector shall notify the contractor and subdivider in writing, of the reasons for requiring the contractor to cease all operations until the defect has been corrected to comply with city requirements and receive proper inspection.

D. Deferral or waiver of required improvements.

1. The Planning and Zoning Commission may defer, reduce, or waive at the time of plat approval, subject to appropriate conditions, the provision of any or all design requirements or improvements as, in its judgment, are not necessarily in the interest of the public health, safety, and general welfare.
2. Whenever it is deemed necessary by the Planning and Zoning Commission to defer the construction of any improvements required in this chapter because of incompatible grades, future planning, inadequate or lack of connecting facilities, or for other reasons, the subdivider shall pay their share of the costs of the future improvements prior to approval and recording of the final plat. In lieu of a cash payment, the subdivider may use one of the other improvement guarantees set forth in this chapter.

E. Public construction contracts.

For projects where the city of Bastrop will act as developer, plans and specifications shall be prepared for approval by the City Engineer and projects bid according to requirements of the Texas Local Government Code. Contractors will be required to provide performance bonds, payment bonds, insurance and a two-year (2 yr) maintenance bond in accordance with city requirements. The developer shall be required to pay a cash deposit to cover the work in accordance with the terms of the developer's agreement.

F. Private developer construction contract requirements.

For private development projects, the developer may enter a private contract to complete the required public improvements. The developer/contractor will be required to provide the city the following sureties:

1. Since the developer is providing a financial assurance surety to cover performance under Section 10.28.020.B, a separate performance and payment bond is not required from the contractor; however, it may be in the developer's best interests to require those from their contractors since the city will not release the financial assurance until work is complete, and a release of lien is provided by subcontractors.
2. Maintenance Bond. The contractor will be required to make a maintenance bond of not less than one hundred percent (100%) of the contract price conditioned upon the maintenance of

and the repairs to the construction under the developer's agreement for a period of two (2) years from the date of city acceptance of the project. All contractors employed by the subdivider shall furnish the city a good and sufficient two-year maintenance bond, in an amount equal to one hundred percent of the costs of the improvements, executed by a reputable and solvent corporate surety, holding a license to do business in the state of Texas, in favor of the city to indemnify the city against any repairs which may become necessary to any part of the construction work performed in connection with the subdivision, arising from defective workmanship or materials used therein, for a full period of two (2) years from the date of final acceptance of the entire project. Final acceptance will be withheld until the maintenance bond is furnished to the city. Such bond to be approved as to form and legality by the City Attorney.

3. State Sales Tax. The developer's agreement is usually for the improvement of streets, storm sewers, or utilities in right-of-way which will be dedicated to the public and the city of Bastrop, an organization which qualifies for exemption pursuant to the provisions of Article 20.04(F) of the Texas Limited Sales, Excise and Use Tax Act, as may be amended. The contractor performing this construction can probably purchase, rent or lease all material, supplies, and equipment used or consumed in the performance of the developer's agreement by issuing to their supplier an exemption certificate in lieu of the tax, such exemption certificate complying with state comptroller's ruling #95-0.07. Any such exemption certificate issued by the contractor in lieu of the tax shall be subject to the provisions of the state comptroller's ruling #95-0.09 as amended to be effective October 2, 1976.
  4. Insurance. Prior to commencing the work, the contractor shall furnish to the city of Bastrop and/or owner proof of satisfactory carriage of insurance in accordance with the standard requirements of contractors doing work of the nature herein proposed. The amount of insurance shall conform to the requirements in the standard specifications.
  5. Indemnification. The contractor must agree to fully indemnify and save whole and harmless, the city from all costs or damages arising out of any real or asserted claim or cause of action against it of whatsoever kind of character and in addition from any and all costs or damages arising out of any wrongs, injuries, demands or suits for damages, either real or asserted, claimed against it that may be occasioned by any act, omission, neglect or misconduct of the said contractor, their agents, servants, and employees. The contractor must further agree to comply with all applicable laws, regulations, ordinances, buildings and construction codes of the city of Bastrop and the state of Texas, and with any regulations for the protection of workers which may be promulgated by the government, and shall protect such work with all necessary lights, barriers, safeguards, and warnings as are provided for in the specifications and in the ordinances and regulations of the city.
- G. Notice to Proceed: Following approval of the plans and specifications and final plat, the City will issue a notice to proceed after the following has been filed or supplied to the City:
1. Letter from the developer's Engineer certifying the total cost to complete the subdivision ready for acceptance by the City.
  2. Security as set forth in Section 10.28.020.B.
  3. Certificate of Insurance.
  4. Inspection fees as set forth in Appendix A, Section A10.03.003 of the Bastrop Code of Ordinances to cover the costs of review of construction plans and inspections, testing and administration by the City associated with construction within the subdivision.
  5. Letter from the Texas Commission on Environmental Quality approving proposed wastewater collection system and water distribution system, if required.
- H. Changes in Approved Plans and Specifications: After approval by the City Council, any changes in the plans and specifications shall have the recommendation of the City Engineer. Changes that affect or change the scope of the proposed subdivision shall have the added approval of the City Council.

I. General construction requirements.

Prior to initiating any construction work, the contractor and all subcontractors shall conduct a preconstruction conference with the city, City Engineer, city inspector, and all affected franchised utilities. Prior to the preconstruction conference, the contractor shall provide a proposed construction sequence and schedule and a traffic safety plan, if required, for review and approval by the City Engineer. Generally, the following construction sequence shall be employed:

Step 1. Install temporary erosion/sedimentation controls and tree protection;

Step 2. Excavate detention ponds;

Step 3. Rough grading of streets, lots, building pads, etc.;

Step 4. Install utilities and storm drain facilities;

Step 5. Final grading;

Step 6. Paving;

Step 7. Finish detention ponds;

Step 8. Erosion protection, final clean-up.

J. Approval of work and Acceptance by City.

After completion of all contracts for the construction of the subdivision, the subdivider shall notify the City for a final inspection. The City's Engineer or representative shall then perform this inspection to ensure all work meets the approved plans and specifications. All work performed in construction, reconstruction, cutting and repairing of streets, storm sewer and other public improvements shall be subject to the approval of the City Engineer, whose decision shall be final. Approval by the city inspector, City Engineer or other designated representative shall not relieve the developer or their contractor or design engineer from their responsibilities regarding the design and construction of the improvements.

The city shall not release the obligations of any financial assurance, including performance bonds, until the improvements have been approved and accepted by the city. The developer is strongly urged to withhold final payment to the contractor until such acceptance occurs, since the city shall hold the developer responsible for completion of the project. The city shall not approve or arbitrate quantities for which payment is to be based.

1. Acceptance. After approval by the City's Engineer/representative that the subdivision and work (utilities, streets, drainage system) in the subdivision is complete and meets all requirements and specifications, the City Engineer/representative will recommend the subdivision be accepted by the City. Final acceptance by the City will be made after a two (2) year maintenance bond in the amount of one hundred (100%) of the total construction cost of the subdivision is executed by both developer and contractor and as-built plans are turned into the City.
2. Non-acceptance. In the event the subdivision and/or improvements do not meet all specifications and requirements, the City's Engineer/representative will submit to the City Council a list of deficiencies. The subdivider shall have thirty (30) days to correct all deficiencies before final inspection is again made. If all deficiencies have been corrected, the procedure set forth in Section 10.32.020.J.1 above will be followed.
3. Partial Acceptance. The City shall not accept a part of a subdivision before all construction set forth on the approved plans and specifications are completed, except for sidewalks.

K. As-Built Drawings

The Engineer representing the subdivider shall present to the City Engineer, reproducible complete "as-built plans" for all paving, drainage structures, and water and sewer lines within



thirty (30) days after completion of all contracts and as a condition of final acceptance of the subdivision. As-built plans shall also be provided in a digital CAD and/or GIS format acceptable to the City.

L. Ownership and maintenance of completed public facilities.

Upon acceptance by the city of completed construction, all street improvements including construction of streets, alleys, thoroughfares, curbs, gutters, sidewalks, storm sewers, and drainage channels within dedicated right-of-way and easements shall be and remain the property of the City of Bastrop. The contractor shall be responsible for maintenance of the completed public improvement for a two-year period, following acceptance by the city. After expiration of the two-year maintenance period, the improvements shall be maintained by the city.

M. Ownership and maintenance of private and common area facilities.

Except as may be otherwise provided by city ordinance or city policy, it shall be the responsibility of the applicable home owners association, property owners association or individual property owner to maintain any facilities or infrastructure located on private property or within privately-held common areas.

## **Chapter 10.36 - DESIGN STANDARDS AND REQUIREMENTS**

### 10.36.005 - General design principles.

Subdivisions shall be designed using one of two approaches. Within the city limits, developers shall use the City Design Approach described in paragraph A below. Within the City's extraterritorial jurisdiction, developers shall use the Rural Design Approach described in paragraph B below. Developers within the city limits may request to use the Rural Design Approach as an alternative upon approval of the Planning Director. Developers within the ETJ may only use the City Design Approach upon annexation into the city.

A. City Design Approach:

1. Streets: Each neighborhood or business district must provide a highly interconnected network of streets and must accommodate all existing and future modes of transportation, including pedestrians and bicyclists.
  - a. Each street planned must be classified by movement type. Movement type describes the expected driver experience, as follows:
    - a. Speed: Drivers can expect to travel similar to that expected of conventional street design, but with continued emphasis on pedestrian safety and comfort. This includes most arterials. Design speed is 30-35 mph.
    - b. Free: Drivers can expect to travel generally without delay at the design speed; street design supports the pedestrian movement at the higher design speed. This movement type is appropriate for thoroughfares designed to traverse longer distances or connect to higher intensity locations. This includes collectors. Design speed is 25-30 mph.
    - c. Slow: Drivers can proceed carefully with an occasional stop to allow a pedestrian to cross or another car to park. The character of the street should make drivers uncomfortable exceeding the design speed due to presence of parked cars, enclosure, tight turn radii, and other design elements. This usually includes minor collectors and commercial local streets. Design speed is 20-25 mph.
    - d. Yield: Drivers must proceed slowly and with extreme care and must yield to pass a parked car or approaching vehicle (the functional equivalent of traffic calming.) This is usually classified as residential local streets. Design speed is 20 mph or less.

- b. Complete Streets: To the extent feasible and reasonable, all streets should be designed to safely accommodate all transportation modes, including pedestrians, bicyclists, automobiles, and small bus transit. Local and minor collector streets should prioritize pedestrians and bicyclists over motor vehicles.
  - c. Street Cross-Sections: The function of the City street types is to promote walkability and pedestrian comfort, with vehicular mobility as a secondary function. The developer should use one of the street cross-sections shown in the currently-adopted Transportation Master Plan.
  - d. The interconnected network of streets must extend into adjoining areas except when the general infill goal of integration with surrounding uses is deemed inappropriate for an infill site by the Planning and Zoning Commission during the subdivision approval process. Street stubs must be provided to adjoining undeveloped areas to accommodate future street connectivity.
  - e. Streets do not have to form a rectangular grid; they may be curved or bent but must connect to other streets. Intersections with designated arterials and collectors must have centerline offsets of at least 150 feet; this requirement does not apply to intersections that are limited to alleys, lanes or local streets.
  - f. The proposed street network should respect topography and designated environmental resources and be modified accordingly to avoid damages to such resources.
  - g. Sidewalks and rows of street trees must be provided on both sides of all streets; street trees may be omitted where arcades or colonnades meet the standards. To allow healthy tree growth, when street trees will be planted in tree wells or in planting strips narrower than 10 feet, the developer must support the surrounding sidewalk and parking lane with structural soil or provide an equivalent soil volume using a method acceptable to the City forester.
  - h. Dead-end streets or cul-de-sacs are not permitted except where physical conditions such as highways, sensitive natural areas, or unusual topography provide no practical connection alternatives. Each dead-end street or cul-de-sac must be designed as a small green area surrounded by a common driveway serving adjoining lots and should provide pedestrian connectivity to the maximum extent possible.
  - i. All streets must be publicly dedicated. Private streets and closed or gated streets are prohibited unless specifically approved under Section 10.36.030.J.6].
2. Alleys and Lanes: A continuous network of rear and side alleys or lanes must serve as the primary means of vehicular ingress to individuals lots where lots are narrower than 60 feet.
    - a. Alley or lane entrances should generally align to provide ease of ingress for service vehicles, but internal deflections or variations in the alley/lane network are encouraged to prevent excessive or monotonous views of the rear of structures resulting from long stretches of alleys or lanes.
    - b. All alleys and lanes must be dedicated to the public.
  3. Blocks: Except as otherwise provided, block perimeters shall not exceed 1600 linear feet as measured along the inner edges of each street right-of-way. Blocks may also be broken by a Civic Space Lot provided that the lot is 50 feet wide and will provide perpetual pedestrian access between the blocks and to any lots that front the Civic Space lot. Civic Space lots may be owned and managed by a homeowners' association, but public pedestrian access must be provided. Smaller blocks are encouraged to promote walkability.
    - a. Block perimeters may exceed this limit, up to a maximum of 2,000 linear feet, only if one or more of the following conditions apply:
      - 1) The block is assigned to the Form-based Code zone,
      - 2) The block has at least one block face on an arterials street, or

- 3) The block contains valuable natural features or significant historic resources that should not be crossed by a street,
  - b. Any single block face wider than 500 feet must include a publicly-dedicated sidewalk, passage, or trail at least 8 feet in width that connects to another street.
  - c. Blocks for Commercial Use: Commercial shopping centers may accomplish the 1,600-foot block perimeter by using interior public access easements rather than dedicated public streets. The intent of breaking up superblocks must still be achieved.
  - d. Blocks for Industrial Use: Blocks intended for industrial use are not required to meet the 1,600-foot block perimeter, but in no case shall minimum block faces exceed two-thousand-six-hundred feet (2,640') without obtaining a waiver from the Planning and Zoning Commission.
  - e. An applicant may request an exception to propose minor modifications to the block size standards; and the Planning and Zoning Commission may decide to accept, modify or reject such modifications during the approval process. The Commission shall base its determination as to the consistency of the modifications with the planning and design principles set forth in the Comprehensive Plan and this Ordinance.

**B. Rural Design Approach:**

Whereas the residents of Bastrop have chosen protect Bastrop's rural and small-town character instead of promoting traditional suburban sprawl, Bastrop has chosen to provide for rural conservation style subdivisions for future development within the extraterritorial jurisdiction. Furthermore, the City Engineer has determined that a maximum impervious cover of thirty percent (30%) is necessary to protect Bastrop's water quality and prevent water pollution under Texas Water Code Section 26.177.

To accomplish these goals, future subdivisions in the ETJ must be developed using the following five-step process:

1. Evaluate predevelopment conditions and develop a Yield Plan. Existing floodplains, wetlands, steep slopes, wooded areas, farmland, and rangeland should be identified. The number of lots that could be developed at a density of one dwelling unit per acre (1 du/ac), plus streets, should be calculated.
2. Identify primary and secondary conservation areas. Primary conservation areas include floodplains, wetlands and steep slopes (over 10 percent). Secondary conservation areas include wooded areas and other parts of the natural landscape that should be spared from clearing, grading, and development.
3. The next step is to identify potential development areas and locate house sites. Potential development areas are the areas not included in primary and secondary conservation areas. House sites should be placed at respectful proximity to conservation areas, with homes backing to wooded areas and looking out to a pasture area, as an example. The number of houses should be less than or equal to the number of houses calculated in the yield plan and may be clustered.
4. Align the streets and trails to access each of the house sites.
5. Draw in lot lines, leaving the conservation areas as common area lots to be encumbered by dedicated open space or a conservation or agricultural easement. Lots served by onsite sewer facilities (OSSFs) shall meet the minimum lot size required by Bastrop County.

**C. General Design Requirements**

The quality of design of the city is dependent on the design quality of the individual subdivisions that compose it. Good community design requires the coordination of the efforts of each subdivider and developer of land within the community. Therefore, the design of each subdivision shall be prepared in accordance with the design principles, concepts and standards in the comprehensive plan, and in accordance with the following provisions:

1. Physical Conditions. The arrangement of lots and blocks and the street system should be designed to make the most advantageous use of topography and natural physical features. Trees and native vegetation should be preserved. The system of streets and sidewalks, and the layout and arrangement of blocks and lots should be designed to take advantage of the natural and scenic qualities of the area. Land which the City finds to be unsuitable for subdivision or development because of flooding, improper drainage, adverse earth formation, utility or pipeline easements or other features which will reasonably be harmful to the safety, health, and general welfare of the present or future inhabitants of the subdivision or its surroundings, shall not be developed unless adequate methods are formulated by the developer and approved by the Planning and Zoning Commission that will solve the problems created by the unsuitable land conditions.
2. The following general design requirements are intended to facilitate that the proposed subdivision is coordinated with its immediate neighbors with respect to land use, street connections, utilities, drainage facilities, and the possible dedication of parks and open spaces:
  - a. Conformity with Comprehensive Plan. The subdivision shall conform to the comprehensive plan of the city and elements thereof;
  - b. Provision for Future Subdivision. If a tract is subdivided into parcels larger than ordinary building lots, such lots shall be so arranged as to permit the logical location and opening of future streets and possible resubdivision of lots with provision for adequate utility easements and connections;
  - c. Reserve Strips Prohibited. There shall be no reserve strips controlling access to land dedicated or intended to be dedicated to public use;
  - d. Access to Lots. Each lot shall abut on a dedicated public street or access;
  - e. Public Improvements. All public improvements shall be designed and constructed using materials and in a manner to meet or exceed the Standard Specifications Manual for the City of Austin or the city's design standards and criteria for streets, drainage and other public improvements as promulgated by the city manager;
  - f. The subdivision plat shall provide for the logical extension of abutting and proposed utilities and drainage easements and improvements to provide for system continuity and to promote future development of adjacent areas;
  - g. Access to Subdivision. Each subdivision having more than twenty (20) lots shall be designed to have at least two (2) points of access via an improved public street built to permanent standards.
  - h. Land unsuitable for subdivision. Any land that is subject to a one hundred-year (100-year) flood in its natural state shall not be developed. If land is to be reclaimed from the one-hundred-year (100-year) floodplain, then a Conditional Letter of Map Revision (CLOMR) must be approved by the Federal Emergency Management Agency (FEMA) prior to the filing of the final plat or issuance of building permits.
3. Planned Development Districts. To promote the health and general welfare of the community and to preserve and make available open space, the Planning and Zoning Commission may grant a subdivider in the City Limits the right to vary the residential density within a tract being developed that has been zoned "PD" planned development, or which has a "PD" suffix to its regular zoning district designation under the zoning ordinance of the city of Bastrop (Chapter 14 of the Bastrop code of Ordinances). Any deviation from the density and lot area requirements, without approval of a variance as provided in Section 17.16.060 of this code, shall be subject to the following conditions:
  - a. The overall density shall not exceed that of the zone in which the land occurs. The minimum lot area shall not be less than sixty-six percent (66%) of the minimum normally required in the zoning district in which the land occurs;

- b. An overall plan of the entire tract shall be provided showing roads, lot lines, lot areas, easements, encumbrances and other relevant data and shall be submitted in accordance with the subdivision regulations with the locations of individual houses, structures, areas of shrubs, and/or trees to be retained, location of trees of ten-inch diameter (10" dbh) or more, existing contours and proposed grading, drainage and landscaping shown as well.
- D. Low Impact Development Requirements - The City of Bastrop supports the incorporation of low impact development practices into the design of new subdivisions, including:

- Conservation of Natural Features and resources
  - Preserve undisturbed natural areas
  - Preserve riparian buffers
  - Avoid floodplains
  - Avoid steep slopes
  - Minimize siting on porous or erodible soils
- Use Lower Impact Site Design techniques
  - Fit design to the terrain
  - Locate development in less sensitive areas
  - Reduce limits of clearing and grading
  - Use open space development
  - Consider creative designs
- Reduction of impervious cover
  - Reduce roadway lengths and widths
  - Reduce building footprints
  - Reduce the parking footprint
  - Reduce setbacks and frontages
  - Use fewer or alternative cul-de-sacs
  - Create parking lot stormwater "islands"
- Use Natural Features for Stormwater Management
  - Use buffers and undisturbed areas
  - Use natural drainageways instead of storm sewers
  - Use vegetated swale instead of curb and gutter
  - Drain rooftop runoff to pervious areas

The developer must show that they have incorporated two or more of these approaches for each subdivision proposal.

- E. Houston Toad Habitat Conservation Area – All subdivisions within the designated critical habitat for the Houston Toad (*Bufo houstonensis*) must comply with the Lost Pines Habitat Conservation Plan (LPHCP) administered by Bastrop County, or obtain clearance for the proposed subdivision from the U.S. Fish and Wildlife Service. In general, development can occur in one of the following methods through the LPHCP (see Appendix C: LPHCP Conservation Subdivision Development Guidelines, November 30, 2006):
1. No new subdivisions creating additional lots (and habitat fragmentation) can be created unless they use one of the following:
    - a. Tracts greater than ten (10) acres in size can be subdivided using the "low density, large-lot design" approach:
      - (1) Infrastructure may not exceed ten percent (10%) of the total subdivision area,
      - (2) Minimum lot size is three (3) acres, with an average lot size of five (5) acres.
      - (3) Up to 20 percent of each lot may be used for residential or small-scale commercial purposes, with the remaining 80 percent permanently protected as Houston toad habitat.

- b. Tracts greater than twenty (20) acres can be subdivided using the “higher density, clustered design” approach:
  - (1) Infrastructure may not exceed 20 percent of the total subdivision area,
  - (2) No more than one dwelling unit per two-and-one-half (2.5) acres overall density but must be clustered on no more than thirty percent (30%) of the site with individual lots being at least one-half (1/2) acre.
- c. Alternate and innovative designs that meet the intent of preserving Houston toad habitat may be approved by obtaining a variance through the LPHCP Administrator and the U.S. Fish and Wildlife Service (see Section 8.0 of Appendix C: LPHCP Conservation Subdivision Development Guidelines (2006)).
- d. Existing lots of record as of 2003 may develop without subdivision, under the following restrictions:
  - (1) For residential lots less than five (5) acres in size, no more than 0.5 acres of land (habitat) disturbance is allowed,
  - (2) For residential lots five (5) acres or greater in size, no more than one (1) acre of land (habitat) disturbance is allowed.
  - (3) Commercial development is allowed up to one (1) acre of disturbance regardless of lot size.
- F. Wildfire Protection Strategies – For subdivisions within areas that may be subject to wildfires (defined as Primary and Secondary Community Protection Zones as shown on the Texas Wildfire Risk Assessment Portal ([www.texaswildfirerisk.com](http://www.texaswildfirerisk.com)) published by the Texas A&M Forest Service), developers are encouraged to use strategies to develop defensible space around structures such as those promoted by the Federal Emergency Management Agency (FEMA), the National Fire Protection Association (NFPA) (e.g. Firewise®), and the US Forestry Service and Texas Forest Service. In general, these strategies include locating home sites away from wildland vegetation, establish a thirty-foot (30’) Fire Safety Zone around each homesite that is generally free of fire-prone vegetation and materials, and make sure that is adequate ingress and egress from the subdivision during an emergency. A note shall be placed upon the plat, and a provision in the deed restrictions, that dead fuel must be removed from the Fire Safety Zone annually.

#### 10.36.010 - Preservation of trees and native vegetation.

- A. Purpose. The purpose of these regulations is to promote the preservation of trees, tree stands and existing tree canopy, to protect trees during construction, to facilitate site design and construction that contribute to the long-term viability of existing trees, to increase property values and promote environmental sustainability and to regulate the removal of trees. To the extent possible, the natural landscape shall be preserved in its natural state. Structures, driveways, and parking areas shall be designed and located to fit harmoniously with the natural environment and to minimize the necessity for removing trees, native vegetation, and soil, or the addition of fill. Site clearing shall not be permitted beyond what is necessary to provide locations for structures, driveways, parking, or small yard areas not visible from the street. An appeal or an application for relief may be approved by the Planning and Zoning Commission as specified in 10.36.010.G.6. An applicant may also submit a proposal for an alternative tree plan as specified in 10.36.010.I.9.
- B. Coordination with City Ordinances. The developer is reminded that the zoning ordinance requires landscaping (Chapter 14, Exhibit A, Section 39) and that the subdivision ordinance requires street

trees (Section 10.36.030.S below) in certain situations. Sufficient space on each lot should be provided to accommodate these requirements.

C. Applicability. Unless otherwise exempted, this section shall apply to the following in the City Limits and the Statutory ETJ:

1. Undeveloped land; and
2. All property to be redeveloped including additions and alterations, but not including interior or exterior alterations that do not change the footprint of the building and do not require the removal of trees.

D. Exemptions.

1. Developments that have a completed application on file for a preliminary or final plat, site development plan or building permit, whichever is applicable, as of the effective date of the ordinance codified in this section.
2. Any development for which construction has begun on infrastructure improvements pursuant to a city-approved development agreement as of the effective date of the ordinance codified in this section.
3. Property of less than one (1) acre on which a single-family residential dwelling exists.
4. Trees located within the visibility triangle as defined on a plat of record or under Section 10.36.020.D of the subdivision ordinance.
5. Public utilities may be exempted from these requirements upon filing a route plan prior to the removal of trees or initiation of construction which satisfactorily demonstrates that the proposed installation lies within an existing easement recorded prior to the effective date of the ordinance codified in this section.
6. Public utilities have the right to trim, cut and/or remove any trees that:
  - a. Interfere with or encroach upon the operations of existing public utilities; or
  - b. Create a safety issue for utility crews; or
  - c. Create a safety issue for the public.
7. Nursery trees that are planted and growing on the premises of a wholesale nursery that are intended for sale in the ordinary course of business.
8. Any tree determined by the City's Inspector to be diseased, dying, dead, creating a public nuisance or damaging a foundation. The City's Inspector may request that the owner retain a qualified professional (certified arborist, registered landscape architect, or qualified botanist) to make the determination.
9. Any tree determined to be causing a danger or be in a hazardous condition because of a natural event such as a tornado, storm, or flood that endangers the public health, welfare or safety and requires immediate removal.
10. Clearing of understory trees and brush necessary to perform soil borings, boundary surveying of real property or to conduct tree surveys and inventories as long as the clearing for surveying shall not exceed a width of two feet (2') for a general survey (i.e., of easement boundary, etc.) and eight feet for a survey of property boundary lines. No tree having a ten-inch (10") diameter at breast height (dbh) or greater shall be removed under this exemption.
11. Capital improvement projects.
12. Trees located within the right-of-way and the adjacent utility easements.
13. Trees located within drainage facilities (easements and detention ponds) as defined on a plat of record.

14. Exemptions made because of an appeal or an application for relief as specified in Paragraph F below.

E. Tree Designations.

1. Protected Trees. Any healthy tree with an eighteen-inch (18") or greater dbh and not in a quality tree stand or not a Mesquite, Bois d'Arc, Ashe Juniper, Locust, Hackberry, Gum Bumelia, Box Elder, and/or Cottonwood. All trees greater than eighteen inches (18") dbh shall be considered a protected tree unless a detailed tree inventory is submitted by the applicant verifying that it is a Mesquite, Bois d'Arc, Ashe Juniper, Locust, Gum Bumelia, Box Elder, Hackberry, or Cottonwood.
2. Quality Trees. All healthy trees that have a dbh that is greater than ten inches (10") but is less than eighteen inches and not within a quality tree stand shall be considered a quality tree. All trees shall be considered quality trees unless a detailed tree inventory is submitted by the applicant identifying the tree as a secondary tree.
3. Quality Tree Stands. Three or more contiguous quality trees whose canopies are generally clustered together creating a contiguous drip line. All tree stands shall be considered quality tree stands unless a detailed tree inventory is submitted by the applicant identifying the tree stand as a secondary tree stand.
4. Large Secondary Trees. All healthy Mesquite, Bois d'Arc, Ashe Juniper, Locust, Hackberry, Gum Bumelia, Box Elder, and/or Cottonwood trees with a diameter of eighteen inches (18") or greater dbh.
5. Secondary Trees. All healthy Mesquite, Bois d'Arc, Ashe Juniper, Locust, Hackberry, Gum Bumelia, Box Elder and/or Cottonwood trees that have a dbh that is greater than ten inches (10") but less than eighteen inches (18").
6. Secondary Tree Stands. Three or more contiguous secondary trees whose canopies are generally clustered together creating a contiguous drip line. A secondary tree stand must consist of at least eighty percent (80%) of secondary tree species.

F. Permit Required.

1. Unless the tree is exempt under Section 10.36.010.D above, no person, directly or indirectly, shall intentionally cut down, destroy, remove or move, or intentionally destroy or damage any quality tree or protected tree without first obtaining a tree removal permit and complying with the requirements of this section.
2. No grading or excavation permit shall be issued, and no grading shall take place on any undeveloped property that contains trees subject to this section without first obtaining a tree removal permit or demonstrating that a tree removal permit is not required.
3. No heavy equipment shall be moved onto a site prior to all applicable permits being issued.
4. Trees greater than ten inches (10") dbh and not defined as a quality tree or protected tree within this subsection may be removed with a permit.
5. Trees less than ten inches (10") dbh may be removed without a permit. Site clearing may not be completed with heavy equipment under the drip line of the trees or stands to be preserved that are protected in accordance with Section 10.36.010.H.5.

G. Permit Review and Approval Process.

1. A request for a tree removal permit shall be submitted and approved prior to the removal of any quality tree or protected tree in the city.
2. A complete application shall be submitted along with the application fee, if required. The fees shall be established by the city council and published in Appendix A10.03.002 of the Bastrop Code of Ordinances. A complete application includes:



- a. Tree Inventory and Tables. The applicant shall prepare and submit a drawing showing the location and species of each tree with a trunk ten inches or greater (10"+) dbh. In areas of dense vegetation or a tree stand that are proposed to be undisturbed, an outline of the vegetation may be shown. The plan shall be prepared by a registered landscape architect, urban forester, botanist, arborist, or professional land surveyor that has documented completion of at least eight hours of training in Texas tree identification. Tables shall accompany the inventory to identify the tree by the number on the plan and list the tree species, tree designation, and size (dbh). Tree stands or dense vegetation shall be inventoried by the number on the plan and shall specify the area of the continuous drip line. The tree inventory plan shall be in substantial conformity with the plan submitted with the Preliminary Plat application.
  - b. Tree Preservation and Mitigation Plan. The Tree Preservation and Mitigation Plan shall be submitted prior to, or along with the civil plans, grading permit, or building permit application.
3. Tree Inventory and Tree Replacement/Mitigation Plan Required. The applicant shall prepare and submit a drawing showing the location and species of each tree with a trunk greater than ten inches (10") in diameter measured at a point four and one-half feet (4-1/2') above the ground (DBH). In areas of dense vegetation that are proposed to be undisturbed, an outline of the vegetation may be shown. The plan shall be prepared by a registered landscape architect, urban forester, botanist, arborist, or professional land surveyor that has documented completion of at least eight hours of training in Texas tree identification. The tree survey shall be submitted prior to, or along with the preliminary plat application, grading permit, or building permit application.
  4. Tree removal permits shall be valid for a period of one hundred eighty (180) days.
  5. Upon request of the applicant, the Director of Planning shall be authorized to work with the owners, developers, and builders to make non-substantive changes, within the scope of this section, to plans, permits, and other requirements throughout the development and construction processes that will provide the greatest reasonable tree survival. The decision of the Director of Planning may be appealed by the applicant to the Planning and Zoning Commission.
  6. The applicant may file an application for relief from the tree preservation/mitigation requirements to the Planning and Zoning Commission. An application for relief shall include the following items:
    - a. Letter detailing the specific relief requested and rationale;
    - b. Tree inventory and/or aerial;
    - c. Site Plan showing topography and other site-specific features; and
    - d. Alternative tree preservation/mitigation plan.
- H. Preservation. The following requirements for tree preservation and protection shall apply unless an application for relief has been submitted by the applicant and approved by the Planning and Zoning Commission:
1. Any tree designated as a protected tree or a large secondary tree shall be preserved unless mitigation is provided under the requirements of subsection I below.
  2. The minimum percentages of all dbh or percentage tree canopy of quality trees, quality tree stands, secondary trees, or secondary tree stands that must be preserved as shown in Table 10-1. Any request to preserve less than the required amount must be approved by the Planning and Zoning Commission.
  3. All percentages relating to preservation stated within this section shall be based on the initial tree inventory plan. Any subsequent redevelopment of property must minimally preserve the applicable percentage of the total dbh of quality trees by the initial tree survey.

**Table 10-1  
Preservation Requirements for All Subdivisions  
(See Table 10-2 for mitigation requirements)**

Total Subdivision Size	Protected Trees	Quality Tree and Quality Tree Stands*	Large Secondary Trees	Secondary Trees and Stands
Less than ½ acre	None	None	None	None
½ acre to 1 acre	A minimum of 50% of protected trees must be preserved	A minimum of 5% of all quality trees must be preserved, and/or a minimum of five 5% of the area of quality tree stands must be preserved.	A minimum of 5% of large secondary trees must be preserved	None
1 acre to 2.5 acres	A minimum of 60% of protected trees must be preserved	A minimum of 10% of all quality trees and/or 10% of the area of quality tree stands must be preserved.	A minimum of 10% of all large secondary trees and/or 10% of large secondary tree stands must be preserved.	None
Greater than 2.5 acres	A minimum of 70% of protected trees must be preserved	A minimum of 20% of all quality trees and/or 20% of the area of a quality tree stands must be preserved.	A minimum of 20% of large secondary trees must be preserved.	None

\* The minimum percentage required to be preserved may be met in a single quality tree stand.

4. A notation shall be placed on the site plan or final plat referencing the tree preservation and mitigation plan on file with the city planning department. The notation shall limit any future unauthorized land disturbing activity or construction that would impact and/or damage the tree(s) to be preserved or protected.
  5. To preserve the required mandatory areas of natural vegetation landscape from inadvertent damage during construction, a physical barrier shall be erected around the perimeter of these inviolate areas. The barriers will be in place and approved by the City Engineer before any heavy equipment is placed on site or before any site clearance can commence in accordance with Section 10.32.020.G. The barrier may consist of a temporary chain link fence, wooden stake (snow) fence, plastic safety/construction fence or other devices as approved by the City Engineer. Minimum height of all types of barriers is four feet. Barriers shall remain in place until the final building and landscape site inspections are satisfactorily completed for the issuance of the certificate of occupancy. Only after this time can the barriers be removed.
  6. Replacement of any preserved trees or stand which dies within two (2) years due to construction or development activities will be the responsibility of the developer on a one to one (1:1) caliper inch basis.
- I. Mitigation. If preservation cannot be reasonably achieved, then the following mitigation standards shall apply:
1. Protected trees and large secondary trees may be removed if mitigated as required on Table 10-2.

**Table 10-2  
Mitigation Requirements for All Subdivisions  
(Ratios indicate number of caliper inches removed to caliper inches replaced)**

Total Subdivision Size	Protected Trees	Quality Tree and Quality Tree Stands	Large Secondary Trees	Secondary Trees*
Less than ½ acre	If removed, mitigated at a 1:0.25 ratio	If removed, mitigated at a 1:0.25 ratio	If removed, mitigated at a 1:0.25 ratio	None
½ acre to 1 acre	If removed, mitigated at a 1:0.5 ratio	If removed, mitigated at a 1:0.5 ratio	If removed, mitigated at a 1:0.25 ratio	None
1 acre to 2.5 acres	If removed, mitigated at a 1:0.75 ratio	If removed, mitigated at a 1:0.75 ratio	If removed, mitigated at a 1:0.5 ratio	If removed, mitigated at a 1:0.25 ratio
Greater than 2.5 acres	If removed, mitigated at a 1:1 ratio	If removed, mitigated at a 1:1 ratio	If removed, mitigated at a 1:0.75 ratio	If removed, mitigated at a 1:0.5 ratio

\* Mitigation is only required to be calculated for Secondary Trees equal to or greater than twelve inches (12") dbh.

2. Quality trees, quality tree stands, secondary trees and secondary tree stands may be removed in excess of the minimum preservation requirement provided the excess removal is mitigated as required on Table 10-2.
3. Mitigation is only required to be calculated for secondary trees equal to or greater than eighteen inches (18") dbh.
4. Each replacement tree shall be a minimum of two-inch (2") caliper and at least five feet (5') in height when planted.
5. Mitigation shall be calculated for the entire development, as applicable. Trees required for mitigation may be planted at the time of development or when an individual lot is developed. A note shall be placed on the face of the final plat, and a statement provided in the deed restrictions, referencing the tree preservation and mitigation plan on file with the city planning department and noting the calculations for preservation and mitigation for the entire development and for each phase and lot. A mitigation plan and an irrigation plan will be required with the application for each building permit.
6. With the approval of the Director of Planning, fifty percent (50%) of the trees required to be planted as mitigation may be planted off-site at city parks, the city tree farm, or other public areas.
7. If trees are planted as mitigation under this subsection, the developer shall post a two-year (2-yr) maintenance surety bond or cash bond meeting the requirements under Section 10.32.020.B for the cost to replace the trees. Upon completion of the two-year landscape establishment period for replacement trees, the city shall inspect the trees and determine whether ninety percent (90%) of the trees are healthy and have a reasonable chance of surviving to maturity. Upon such a finding, the city shall release the currency or bond. In the absence of such a finding, the applicant shall be notified to replace any unhealthy or dead trees. If the applicant does not take remedial steps to bring the property into compliance, the city shall make demand for payment on the cash bond, surety bond, or letter of credit. The city may use all legal remedies to enforce this Subchapter in addition to making demand on the security provided herein.

8. Money in Lieu of Tree Mitigation.

- a. A land owner/developer responsible for tree mitigation under this Section may request to meet the requirements, in whole or in part, by a cash payment in lieu of tree replacement, upon approval by the Planning Director. The payment shall be on a caliper-inch unit cost as established by the city council in Appendix A10.03.002 of the Bastrop Code of Ordinances. Cash payment shall be deposited in the tree fund and be used to purchase and install trees and landscaping within the city.
  - i. Payment in lieu of tree mitigation for greater than fifty percent (50%) of the required mitigation (greater than fifty percent of total dbh provided as mitigation) shall be subject to approval by the Planning and Zoning Commission.
  - ii. Payment in lieu of tree mitigation for less than or equal to fifty percent (50%) of mitigation requirement (less than or equal to fifty percent (50%) of total dbh provided as mitigation) may be approved by the Director of Planning, provided the Director determines that there is no reasonable alternative to providing mitigation on the development site.
- c. The applicant shall pay the fees for tree removal established by city council in Appendix A10.03.002 of the Bastrop Code of Ordinances. The fee shall be based on the fair market value of materials and labor at the time of planting and the reasonable estimated cost for maintenance and irrigation for a period of two (2) years.
- d. Fees contributed to the tree fund shall be paid prior to the issuance of a grading permit on all commercial, industrial, or multi-family residential developments, prior to final approval of a gas well drilling permit and prior to filing a final plat in the Bastrop county clerk's office for all single-family residential subdivisions.

9. Alternative Tree Preservation Plan. An applicant may propose an alternative tree preservation plan which meets or exceeds the goals and objectives of this subchapter but does not meet the standards of this subchapter. The alternative tree preservation plan provides the option to address the criteria through a flexible process which must be reviewed and approved by the Planning and Zoning Commission.

- a. Criteria for Approval. The goals and objectives which must be met, and by which the proposal will be judged are:
  - 1) The proposed alternative tree preservation plan adequately achieves, or is an improvement on, the intent of the requirements of this subsection;
  - 2) It assures quality development that fits in with the character of Bastrop; and
  - 3) It clearly states the intended preservation objectives.
- b. Tree Credits.
  - 1) All quality trees and quality tree stands that are preserved beyond the minimum requirements identified in Table 10-1 shall be credited towards the landscape tree requirements identified in the zoning ordinance at a ratio of one to one (1:1) caliper inches.
  - 2) All quality tree stands with existing understory trees that are preserved beyond the minimum requirements identified in Table 10-1, shall be credited towards landscape requirements at a ratio of one to two (1:2) caliper inches.
  - 3) Unless trees preserved are an integral part of the parking lot design, they will not be credited towards parking lot landscaping requirements.

J. Enforcement.

1. The City Engineer, building official, or an authorized representative of the city shall have the authority to place a stop work order on any activity involving the removal of protected tree(s), protected tree stand, quality tree(s), or quality tree stand(s), or that may otherwise endanger

trees contrary to the provisions of this subsection. The building official may deny all permits and certificates of occupancy for any site which is not in compliance with this subsection.

2. A person may be held criminally responsible for a violation of this subsection if the person intentionally removes, assists in the removal or causes the removal of a tree without complying with the requirements of this subsection or owns part or all the land where the violation occurs.
3. Each tree removed in violation of this subsection shall constitute a distinct and separate offense.
4. Each tree preserved or planted under this subsection that is removed, destroyed or dies within two years of approval shall constitute a distinct and separate offense.
5. It shall be an affirmative defense that trees are injured or destroyed by natural causes, natural disasters, including but not limited to tornadoes, straight-line winds, ice storms, fire, floods, hail, or lightning strikes, or through the independent unauthorized actions of third parties.
6. In addition to the penalties provided in Section 1.01.009 of the Bastrop Code of Ordinances, the city may also seek damages equivalent to the replacement costs of the trees that were removed or destroyed without authorization.

#### 10.36.020 - Easements.

The subdivider shall dedicate or grant easements as follows:

##### A. General Policy.

1. Easements should normally be provided along the front, rear or side lot lines.
2. Utility easements shall be a minimum of ten feet (10') in width, unless otherwise specified in this chapter or approved by the City Engineer.
3. A ten-foot (10') utility easement shall be required adjacent to street rights-of-way to accommodate the location of underground and overhead utilities according to standardized locations in the City's Design Standards.
4. Easements can be required by the City to be highly restrictive. In such cases, the city will draw the easement instrument to be executed by the subdivider prior to approval of the plat.
5. When the city finds that easements in areas adjoining a proposed subdivision are necessary to provide adequate drainage or to provide utilities, the subdivider shall obtain such easement.
6. Drainage easements shall generally be located along the existing drainageway and should be of sufficient width for the designed improvements (if any) to be installed and enough extra width for maintenance equipment to be able to work.
7. All drainage easements shall be so designed to allow maintenance equipment to enter the easement and be able to perform the necessary work.
8. Employees of the City of Bastrop and its agents shall have the authority to enter premises at any time for the purpose of inspecting, repairing or constructing within any easement.
9. All easements or fee strips created prior to the subdividing of any tract of land must be shown on the subdivision plat. The subdivider shall plat lots and dedicate or grant easements for utilities and drainage ways in the following manner:
  - a. Easements for utilities, drainage ways or transmission lines shall be retained on front, side, and/or rear lot lines as required by the City and utility companies. Easements across parts of a lot other than as described above shall be required as deemed necessary and most appropriate by the City. The City Engineer shall require access for ease of maintenance of all easements.

- b. No lot less than 0.6 acres shall contain easements for transmission lines or surface drainage facilities including but not limited to ditches, channels and ponds. In subdivisions containing such lots, easements shall be contained in a dedicated right-of-way or separate reserve as deemed necessary and most appropriate by the City.

#### B. Privately-owned Easements, Fee Strips

1. All easements or fee strips created prior to the subdividing of any tract of land must be shown on the subdivision plat with appropriate notations indicating the name of the holder of such easement or fee strip, the purpose of the easement and generally the facilities contained therein, the dimensions of the easement or fee strip tied to all adjacent lot lines, street right-of-way and plat boundary lines and the recording reference of the instruments creating and establishing said easement or fee strip.
2. In those instances where easements have not been defined by accurate survey dimensions such as "over and across" type easement, the subdivider shall request the owner of such easement to accurately define the limits and location of their easement through the property within the plat boundaries. If the holder of an undefined easement does not define the easement involved, the subdivision plat must provide accurate information as to the centerline location of all existing pipelines or other utility facilities placed in conformance with the easement owner's rights.
3. A letter, statement, or other instrument from the owner of any privately-owned easement within the plat boundaries must be provided where such easements are proposed to be crossed by streets (either public or private) or public utility or drainage easements, stating that the owner of such easement approves such crossing of their private easements for the purposes intended and depicted upon the plat.
4. Where an instrument of record is submitted in lieu of a letter or statement from the owner of any such private easement, the City shall then refer such instrument to the City Attorney for their determination as to whether the conditions in such instrument are sufficient to adequately provide or accommodate the crossings of such private easement by the proposed streets (either public or private) or public utility or drainage easements depicted on the plat.
5. In those instances where easements have not been defined by accurate survey dimensions such as "over and across" type easement, the subdivider shall request the owner of such easement to accurately define the limits and location of their easement through the property within the plat boundaries. If the holder of an undefined easement does not define the easement involved, the subdivision plat must provide accurate information as to the centerline location of all existing pipelines or other utility facilities placed in conformance with the easement owner's rights.
6. A letter, statement, or other instrument from the owner of any privately-owned easement within the plat boundaries must be provided where such easements are proposed to be crossed by streets (either public or private) or public utility or drainage easements, stating that the owner of such easement approves such crossing of their private easements for the purposes intended and depicted upon the plat.
7. Where an instrument of record is submitted in lieu of a letter or statement from the owner of any such private easement, the City shall then refer such instrument to the City Attorney for their determination as to whether the conditions in such instrument are sufficient to adequately provide or accommodate the crossings of such private easement by the proposed streets (either public or private) or public utility or drainage easements depicted on the plat.

#### C. Utility Easements.

1. Easements. All easements which will be used for water and/or sewer facilities, or which may potentially be used in the future for water and/or sewer facilities shall be a minimum of fifteen feet (15') in width. Easements may be greater or lesser than fifteen feet (15') in width as required by the City Engineer.

2. Any franchised or authorized public utility, including the City of Bastrop, shall have the right to move and keep moved all or part of any building, fences, trees, shrubs, other growths or improvements which in any way endanger or interfere with the construction, maintenance, or efficiency of its respective systems in any of the easements shown on the plat; and any public utility, including the city of Bastrop, shall have the right at all times of ingress and egress to and from and upon such easements for the purpose of construction, reconstruction, inspection, patrolling, maintaining and adding to or removing all or part of its respective systems without the necessity at any time, of procuring the permission of anyone.
3. All easements which will be used for water and/or sewer facilities, or which may potentially be used in the future for water and/or sewer facilities shall be a minimum of fifteen feet (15') in width. Easements may be greater or lesser than fifteen feet (15') in width as required by the City of Bastrop.
4. Bastrop Power & Light (BP&L) easements: Ten-foot (10') easements shall be provided along all street frontages (front and second front lot lines). Ten-foot (10') easements shall also be provided along the side and rear lot lines, though BP&L may request twenty-foot-wide (20') easements where necessary to provide safe access to the electric lines. Additional easements will be required for any ground-mounted transformers.

D. Public Open Space Easement for Visibility

1. A triangular public open space easement (P.O.S.E.) is required on corner lots at the intersection of two streets (including alleys and private streets.) The triangles shall be described as starting at a point located fifteen feet (15') behind the curb line on the intersecting street and extending along the street a distance (SDI and SDr) shown in Figure 10-6 depending on the design speed of the street. Alternatively, the distance (WI and Wr) can be used where curb lines are present on both legs. The area on the private lot must be encompassed by a public open space easement. Two triangles are required on each leg of the intersection.
2. These open space easements will remain in effect unless vacated by ordinance adopted by the City Council of the City of Bastrop.

E. Drainage Easements. Where a subdivision is traversed by a watercourse, drainageway, natural channel or stream, there shall be provided an easement or right-of-way conforming substantially to the limit of such watercourse, plus additional width to accommodate future needs as determined by the comprehensive plan and the city manager. Natural waterways and channels should be used wherever practical to carry runoff. Any modification to an existing waterway and channel requires approval by the City Engineer and city manager.

Easements shall be retained along drainageways, which carry drainage away from roads or which convey main drainage from and through the lots or tracts. Easements shall be a minimum of twenty-five-feet (25') wide for open drainage channels or sized to accommodate the 100-year flood plain. A suitable note on the plat must restrict all properties within the subdivision insuring that drainage easements within the plat boundaries shall be kept clear of fences, building, planting that would obstruct the flow of water, and other obstructions to the operations and maintenance of the drainage facility.

1. Storm drainage easements of fifteen feet (15') minimum width shall be provided for existing and proposed enclosed drainage systems. Easements shall be centered on the systems. Larger easements, where necessary, shall be provided as directed by the City Engineer.
2. Storm drainage easements along existing or proposed open channels shall provide sufficient width for the required channel and such additional width as may be required for ingress and egress of maintenance equipment; to provide clearance from fences and space for utility poles; to allow maintenance of the channel bank; and, to provide necessary slopes along the bank. Easements shall be a minimum of twenty-five feet (25) wide for open drainage channels or sized to accommodate the 100-year flood plain. A suitable note on the plat must restrict all properties within the subdivision insuring that drainage easements within the plat

Figure 10-6 Sight Visibility Requirements

Assumptions: At-grade intersection with approaches of 3.0 or less; 3.5 ft. driver eye height above pavement; Both drivers can see each other

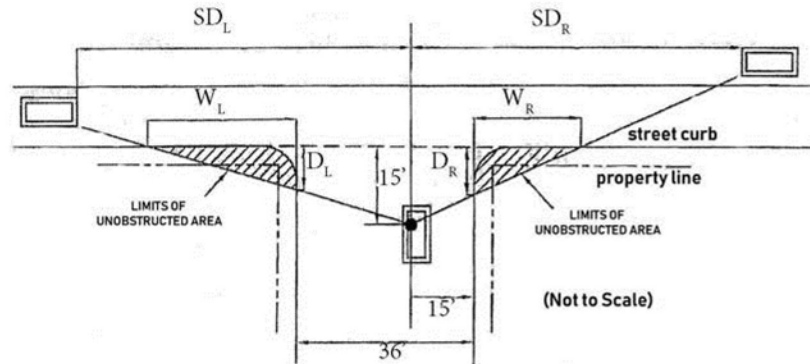

Thoroughfare Class	Speed Limit	Minimum Sight Distance		90 Degree Intersection Only			
		$SD_L$	$SD_R$	$W_L$	$W_R$	$D_L$	$D_R$
L1, L2	20 mph	180	190	89	80	13	13
L1, L2	25 mph	245	255	128	111	13	14
L1, L2, C2, C3	30 mph	315	325	210	120	13	14
C2, C3, S4, S5	35 mph	390	400	270	165	14	14
S4, S5	40 mph	480	545	330	210	14	14
S4-80, S4-100, A4	45 mph	580	650	400	260	14	14
A6-100, A6-120	50 mph	585	655	400	260	14	14

$SD_L$  and  $SD_R$  are the required sight distance, in feet, to the left and to the right as measured from the driver's eye on the controlled intersection approach looking towards oncoming cross traffic.

$W_L$  and  $W_R$  are the distance, in feet, along the curb line of the side of the visibility triangle parallel to the path of traffic on the uncontrolled intersection approach.

$D_L$  and  $D_R$  are the distance, in feet, along the curb line of the side of the visibility triangle parallel to the path of the driver on the controlled intersection approach.

The distances given for  $W_L$ ,  $W_R$ ,  $D_L$ , and  $D_R$  are applicable to 90-degree intersections only.

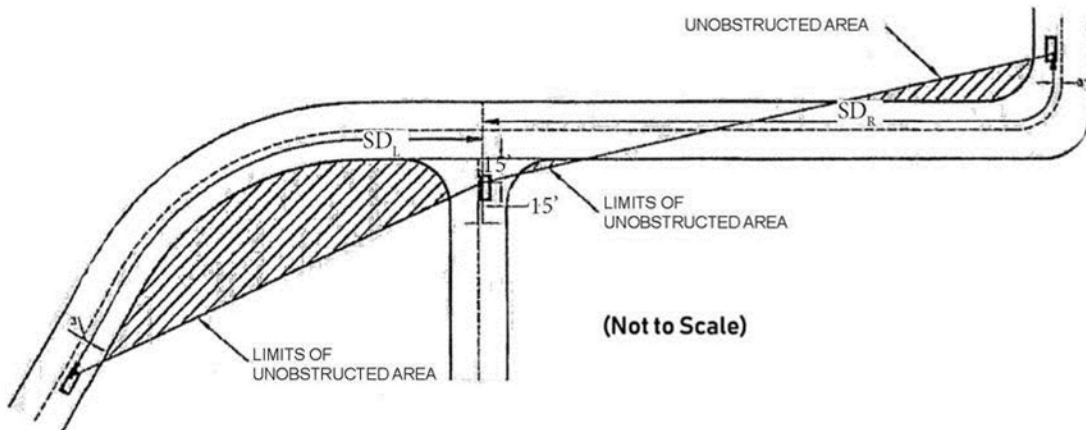



boundaries shall be kept clear of fences, building, planting that would obstruct the flow of water, and other obstructions to the operations and maintenance of the drainage facility.

3. Where topography or other conditions are such as to make impractical the inclusion of drainage facilities within road rights-of-way, perpetual unobstructed easements for such drainage facilities shall be provided across property outside the road right-of-way lines and with satisfactory access to the road. Easements shall be indicated on the plat. Drainage easements shall be carried from the road to a natural watercourse or to other drainage facilities.
4. When a proposed drainage system will carry water across private land outside the subdivision, appropriate drainage rights must be secured and indicated on the plat or other instrument as approved by the City Attorney. Easements in areas adjoining a proposed subdivision necessary to provide adequate drainage thereof or to serve such subdivision with utilities, shall be obtained by the subdivider prior to final plat approval. In the case of clear public interest, the city may participate in easement acquisition by power of condemnation.
5. The applicant shall dedicate an appropriate drainage easement either in fee or by drainage easement or by conservation easement of land on both sides of existing watercourses to a distance to be determined by the City Engineer.
6. Easements for storm drainage facilities shall be provided at locations containing proposed or existing drainageways.
7. Storm drainage easements shall be provided for emergency overflow drainageways of sufficient width to contain within the easement storm water resulting from a one hundred-year frequency storm less the amount of storm water carried in an enclosed system of a capacity required by the City of Bastrop.
8. The width of the easements shall be substantiated by a drainage study and drainage calculations or other criteria submitted to and approved by the City Engineer.
9. Floodplain Easements. Floodplain easements shall be provided along natural drainageways and lakes or reservoirs. Floodplain easements shall encompass all areas beneath the water surface elevation resulting from a storm whose design frequency is one hundred years (or a one-percent annual probability), plus such additional width as may be required to provide ingress and egress to allow maintenance of the banks and for the protection of adjacent property, as determined and required by the City Engineer.
10. Detention area easements shall be provided that completely encompass the pond and associated improvements. Detention ponds on nonresidential property shall be maintained by the property owner's association, unless otherwise approved by the city.
11. Streambank Buffer Easements – A 50-foot stream buffer easement shall be provided along any the major stream channels (Colorado River, Piney Creek, Gills Branch, or any other perennial stream) with no grading or vegetation removal to serve as a streambank buffer for erosion and for water quality protection. No buildings may be constructed within the streambank buffer and any fences within the 100-year floodplain shall be designed to not impede flow, including by debris that may be caught in the fence.

F. Access Easements.

1. Emergency access easements and fire lanes will be provided where required by the Fire Marshal or the City Engineer and shall be a minimum of twenty feet (20') in width, have a minimum height clearance of fourteen feet (14'), and have a minimum inside turning radius of twenty-five feet (25'). Any emergency access and fire lane easement more than one hundred feet (100') in length shall either connect at each end to a dedicated public street or be provided with a cul-de-sac having a minimum diameter of ninety-six feet (96') with an additional distance of ten feet (10') on all sides clear of permanent structures. These easements shall be paved to design standards and specifications recommended by the City Engineer.

2. Cross access easements shall be required from one commercial lot to the adjacent commercial lot to allow circulation without entering the public street.
3. Commercial and Industrial Services. Appropriate service ways for off-street loading and unloading, not less than twenty feet (20') in width, shall be provided to serve commercial and industrial sites and convenient to driveway entrances and exits.

#### 10.36.030 - Streets.

##### A. General.

1. Street Layout. The arrangement, classification, character, extent, width, grade and location of all streets shall conform to the thoroughfare plan and the official street construction standards and shall be designed in accordance with the following provisions: adequate streets shall be provided by the subdivider and the arrangement, character, extent, width, grade and location of each shall conform to the comprehensive plan of the city and shall be considered in their relation to existing and planned streets, to topographical conditions, to public safety and convenience, and in their appropriate relationship to the proposed uses of land to be served by such streets. The street layout shall be devised for the most advantageous development of the entire neighborhood.
2. Relation to Adjoining Street System. Where necessary to the neighborhood pattern, existing streets in adjoining areas shall be continued, and shall generally be as wide as such existing streets in alignment therewith. Streets of new subdivisions shall be in line with existing and/or proposed streets in adjoining property except where, topography, requirements of traffic circulation or other considerations make it desirable to depart from such alignment.
3. Street Names. New streets in Subdivisions shall be named to provide continuity with existing streets and to prevent conflict with identical or similar names in other parts of the City and/or County as determined by the 911 coordinator for the City and/or County. Street names for new subdivision streets may be suggested by the Subdivision owner/developer. If these names are reasonable and are not similar to existing names of streets in Bastrop County, then they will be reviewed for approval on the final plat. Suggested names shall be submitted by the Developer for approval prior to the Preliminary Plat submittal to the City's Address Coordinator, who will work with the County 911 Coordinator to verify there are no conflicts. . The Planning Director shall have the final authority to approve street names in accordance with current policies. The developer may appeal the decision by the Planning Director to the Planning and Zoning Commission for reconsideration with concurrence from the County 911 Coordinator.
4. Projection of Streets. Where adjoining areas are not subdivided, the arrangement of streets in the subdivision shall make provision for the proper projection of streets into such unsubdivided areas. The City may require that residential streets be stubbed out to adjacent undeveloped property to provide adequate circulation to adjacent tracts. Collector streets shall be extended to adjacent undeveloped property as determined by the City upon consideration of future circulation roads of the area.
5. Boundary Streets. When land proposed to be subdivided is partially or totally bounded on one or more sides by a street or thoroughfare having a right-of-way width of less than that specified in this section, additional right-of-way shall be dedicated to provide one-half of the ultimate right-of-way width. Additional right-of-way dedication to the public may be required as consistent with roadway plans and future traffic demands to the extent of fifty percent (50%) of the total requirement on the subdivision side of the existing or proposed right-of-way centerline as established prior to any additional dedications on the opposite side. A half-street along adjoining property that has not been subdivided may be shown on the general development plan of an entire subdivision, but no lots fronting upon such half-street shall be included in the subdivisions that are approved. Half-streets shall be prohibited, except where essential to the reasonable development of the subdivision in conformity with the other requirements of these regulations, and where the commission finds it will be practicable to

require the dedication of the other half when the adjoining land is subdivided. The other half of the street shall be platted within the adjacent tract at the time it is platted. When land proposed to be subdivided is partially or totally bounded on one or more sides by a street way or thoroughfare having a width of less than that specified in this section, such land shall be laid out to provide street widths specified in this chapter.

6. Streets on Comprehensive Plan. Where a subdivision embraces a street as shown on the comprehensive plan of the city, such street shall be platted in the general location and of the width indicated by the comprehensive plan.
7. Design of Local Streets. Local streets shall be laid out to serve only local traffic and to discourage their use by through traffic. Local streets in residential subdivisions shall be designed in a grid pattern, except when:
  - a. In the determination of the Planning and Zoning Commission, the shape or topography of the subdivision, or existing pattern of the adjacent street would make the provision of such grid streets impractical; or
  - b. The subdivision is part of and conforms to an unexpired preliminary plat approved prior to the adoption of the ordinance codified in this chapter and the design standards and criteria.
8. Adequate Access. To ensure adequate access, there should be at least two planned points of ingress and egress to each subdivision with more than twenty (20) lots.
9. Access to Collectors and Arterials.
  - a. Residential Access. Individual lot access to arterials and collectors for residentially-zoned subdivisions shall be prohibited. Lot access to minor collectors shall be prohibited unless specifically approved by the city. The design should provide a minimum number of access points to collector streets.
  - b. Where a residential subdivision borders on or contains an existing or proposed arterial, the Planning and Zoning Commission shall require that access to such streets be limited where possible by:
    - (1) The subdivision of lots to back onto the arterial and front onto a parallel local street with no access from the arterial;
    - (2) Providing a series of short cul-de-sacs, U-shaped local streets, or short loops entered from and designed generally at right angles to a parallel street, with the rear lot lines of their terminal lots backing into the arterial;
    - (3) Lots to side onto the arterial with a non-access restriction on the arterial side;
    - (4) Reverse frontage with screening and containing a non-access restriction along the rear property line; or
    - (5) Other treatment as may be necessary or required for adequate protection of adjoining properties, and as approved, by the commission after taking into consideration the proposed method of off-street parking and maneuvering which will prevent the necessity of backing into the arterial.

Subdivisions serving areas in a single-family residential zoning district that abuts on or contains an existing or proposed arterial or collector street should be designed so that direct vehicular access from any lot to such street is prohibited. The design should provide a minimum number of access points to collector streets.
10. Arterial Intersections. Wherever possible, arterials should be intersected only by collector streets or other arterials, rather than local streets. No offsets at the intersection of two collector streets and/or arterials shall be permitted. There shall be a minimum of six hundred feet between intersections of arterials and/or collector streets.

11. Relation to Lots. All streets should be planned so that all resulting lots shall be sufficient size and shape to conform to applicable zoning regulations. Streets should be platted to allow two tiers of lots between streets when possible, except where single-loaded streets are required near rivers and public parks (see 10.36.040.B.12 and 13).
  12. Street Right-of-Way. The subdivider shall be required to dedicate appropriate right-of-way for all streets required within or abutting such subdivision in accordance with the adopted thoroughfare plan and Table 10-3.
  13. Visibility Triangles. Visibility triangles in the form of public open space easements (P.O.S.E.) shall be provided at the intersection of all public streets and the intersection of all public streets and alleys and/or private streets as required in Section 10.32.020.D of this chapter. The easement shall prohibit any obstruction within the easement from a height of twenty-four inches to a height of eleven feet above the top of the adjacent curb. Utility poles and guy wires may be located in the P.O.S.E. Other ground-mounted electrical and communication equipment and switch gear may be located within the P.O.S.E. when the location is coordinated with the city planner.
  14. The reservation in private ownership of strips of land at the end of proposed or existing streets and intended solely or primarily for controlling access to property not included in the subdivision shall be prohibited.
  15. Bicycle Lanes and Routes: To the extent possible, streets shall be designed to accommodate bicycles. For local streets and low volume collectors, shared lanes may be used. For arterials and higher volume collector streets, separate bike lanes shall be provided.
- B. Street Costs and City Participation. The owner or developer shall be responsible and pay all costs for the design and construction of streets within the proposed development. The developer shall build these streets in accordance with city standards.
1. Rural Subdivision Street Standards. Existing County roadway(s) that connect a proposed rural subdivision development to an Arterial, Collector or Residential, as defined below; that will have increased vehicular traffic (more than 30 trips per day) as determined by the County Engineer, shall be re-constructed by the subdivider to a condition that will provide a service level represented by the proposed development.
- C. Traffic Impact Analysis Required.
1. A traffic impact analysis (TIA) shall be required for any development that will generate more than one hundred (100) trips per peak hour, or more than an average of one thousand (1,000) trips per day, whichever is greater, using data from the most recent edition of Trip Generation published by the Institute of Transportation Engineers. In general, this includes any development with more than one hundred (100) dwelling units or shopping areas with more than 20,000 square feet of floor area. Proposed developments which have access only to a residential or collector street shall require a TIA if the expected number of trips generated by the project exceeds three hundred (300) vehicle trips per day over the uses in existence at the time the TIA is submitted for approval by the City.  

Traffic Impact Analysis studies shall be prepared by a qualified traffic engineer using generally accepted techniques. The regulations in this section apply to existing and future transportation networks associated with land development activities, within the city limits and within the City's extraterritorial jurisdiction. Any application for site development in accordance with this Code must comply with these standards.
  2. Phased Developments: When required, an initial TIA shall be submitted with the first preliminary plat. If the City Engineer determines that a follow-up TIA is needed, the updated TIA shall be submitted with each future preliminary plat of a development submitted for approval and shall be generally consistent with the initial TIA. The initial TIA shall be updated whenever the final plat is modified to authorize more intensive development, or when a period of twelve (12) months has passed since the prior TIA was submitted but the development has

not been initiated. The initial TIA and updated TIAs shall consider the cumulative impacts of all future phases of the development and not segment the impacts into smaller amounts that would avoid identification of and participation in any needed capital improvements. The purpose of this section is to require that development within the Bastrop jurisdictional area is supported by an adequate roadway network to accommodate the continuing growth and development of the City and its jurisdictional area. Acquisition of new rights-of-way for off-site, abutting and internal streets to support new development is necessary and desirable. The City requires that:

- a. development impacts are mitigated through contributions of street rights-of-way and/or improvements to existing and new roadways; and
- b. new developments contribute their fair share of the costs of needed transportation improvements; and
- c. adequate infrastructure for new development is adequately evaluated and addressed.

The City seeks rough proportionality between the traffic impacts created by a new development and requirements placed on the property owner or applicant for new development to dedicate and improve off-site, abutting and internal street rights-of-way to City standards. The City will evaluate the project and determine what dedications, if any, are required to address both the nature and extent of the impact that results from the proposed development. The City desires to assure both that development impacts are mitigated through contributions of street rights-of-way and transportation system improvements and those new developments contribute their fair share of the costs of transportation improvements. It is the City's intent to institute a procedure to assure that mandatory dedications of street rights-of-way and street construction requirements are proportional to the traffic demands created by a new development.

3. If the traffic impact will affect a state-controlled highway then the developer must coordinate the necessary improvements with the Texas Department of Transportation (TxDOT). When a Final Plat is submitted the developer must have obtained an agreement on the necessary road improvements and submitted an agreement between the City of Bastrop and the Developer to meet the requirements established by TxDOT. This will require the developer to coordinate with TxDOT and request TxDOT to submit the necessary contract documents between TxDOT and the City of Bastrop to use as a basis for the transportation agreement between the City of Bastrop and the Developer. A Final Plat cannot be recorded until the agreement has been finalized and the necessary funds (or, alternatively, approved fiscal assurance instruments) are deposited with the City of Bastrop.
4. The City Manager or their designee shall be the primary point of contact with the landowner or developer or their agents, and has considerable authority and responsibility for administering the provisions of this section of the Code; however, all final decisions concerning participation in costs and completion of improvements affecting City streets and any County Roads that will be annexed into the City as part of the development must be specified in a traffic impact analysis, capital improvements plan, or mitigation plan as required in this section and shall [be] presented to the Planning & Zoning Commission for its evaluation and recommendation to the City Council, and, ultimately, shall be submitted to the City Council for its review, evaluation and action (e.g., approval or denial).
5. Scope Determination: When a TIA is required, the City Engineer or their designee shall determine the type and scope of the study during a scoping meeting. This scoping meeting shall be scheduled by the developer following Sketch Plat review and before Preliminary Plat submittal. The City Engineer or their designee may involve representatives of or request assessments from other agencies and departments and consultants. The elements to be determined during the scoping session shall include the following:
  - a. Type of Study: The possible types of reports include: a letter report, full TIA report or special report (e.g., sight distance survey). The TIA shall be certified by a registered professional engineer with a specialty in the field of transportation engineering.

- b. Definition of Impact Area: The points of access and key streets and intersections that may be affected by development of the subject tract constitute the impact area. Traffic recorder and turning movement assessment locations shall also be determined.
- c. Period of Analysis: Periods of analysis may include: daily traffic, AM, PM or weekend peak hour.
- d. Analysis Scenarios: Scenarios for analysis shall include: existing conditions, opening year conditions with and without development, and ten (10) years after opening with and without development, unless the City Manager or their designee specifies a different scenario based on unusual circumstances. If specific land uses for the development are not specified at the time of subdivision or plat application, the daily trip generation rate for the most intensive land use from the ITE Manual for the land use classification of the application shall be used to compute the estimated average daily trips.
- e. Growth Rate Assumption: The rate of growth assumed in background traffic assumptions.

Following approval of the TIA scope, copies of the document shall be sent to the City Engineer or their designee. The City Engineer shall determine the number of copies of the TIA that the applicant will be required to submit.

If Bastrop County and/or the Texas Department of Transportation (TxDOT) roads are affected and they have reached agreement with the Developer, then the developer shall submit a copy of the letter from Bastrop County and/or the TxDOT that outlines any agreements between the developer and Bastrop County and/or TxDOT for planned improvements to County and/or State roads abutting subdivisions or sites and the trigger for such improvements.

- 6. Traffic Study Elements. A letter report or special report shall only include those elements agreed upon in the scoping meeting. The TIA shall follow standard transportation engineering practices processes for determining trip generation and distribution including trip generation category, diversion assumptions, distribution assumptions, and the adequacy of the road network to serve the proposed development, and whether off-site road dedication and improvements should be made to mitigate the effects of the development proposed in the application. The data and methods used in the TIA shall be based upon the latest editions of ITE manuals.

A full TIA shall include, at a minimum, the following elements:

- a. Existing Condition Survey, including analysis of existing traffic levels;
- b. Existing Street System Description: The street system shall be described including geometric features, lane usage, traffic control, signage, sight distances and adjacent uses and curb cuts.
- c. Traffic Volumes: Existing traffic volumes shall be provided for the impact area including both AADT (Average Annual Daily Traffic) and "Design" peak hour volumes. AADT may be derived from current counts of the City or TxDOT (if available) and peak hour volumes shall be based on field counts. Data shall be adjusted for daily and seasonal variations. Turning movement counts for the peak hour shall be provided for critical intersections. Peak hour periods shall be as determined at the scoping meeting.
- d. Capacity Analysis: Existing capacity of signalized and unsignalized intersections.
- e. Other items may be required at the discretion of the City Engineer or their designee depending upon the type and scale of the project. These may include, but are not limited to: queue length analysis, pedestrian counts, accident data, traffic speeds (both 50th and 85th percentile), and stopping sight distances.
- f. Future Without Development: Capacity analysis is to be provided for opening year and plus 10-year conditions for key intersections (and roadway segments where appropriate)

without the development but including any planned developments. The analysis shall be based upon methodologies approved in advance by the City Engineer or their designee.

g. Future with Development

- (1) The TIA shall include a detailed description of the area street network, a description of proposed land uses, the anticipated stages of construction, the anticipated completion date of the various phases of land development, and the trigger points requiring implementation of all described improvements.
- (2) Trip generation and distribution of proposed development Projections of the daily and peak hour traffic generation of the project shall be made using the latest edition of the ITE Trip Generation Manual unless the City Engineer or their designee determines that locally derived data will provide more accurate forecasts. Data from similar facilities may be used where the information is not available from ITE.
- (3) The projected trips shall be distributed onto the road network as agreed in the scoping meeting.
- (4) Capacity analysis for opening year and plus 10-year conditions for key intersections (and roadway segments where appropriate). Capacity analysis and level of service on affected roadways Capacity analysis and level of service on affected roadways Identification of traffic impacts, needs and deficiencies; and
- (5) Special analysis as may be required to determine warrants for signalization, minimum safe sight distances, turning radius requirements, turning lane or acceleration/deceleration lane length analysis, curb cut locations or similar requirements.

As a general policy, the city of Bastrop has adopted the level-of-service "C" as the minimum acceptable congestion level for Bastrop roadways. Review and approval of the traffic impact analysis and any required improvements shall be made by the City Engineer.

7. Mitigation Plan: Recommendations for site access and off-site improvements.

The TIA shall identify the need and timing for transportation improvements, including site access and off-site improvements if any, needed to maintain an acceptable level of service during each phase of development. Where the analysis indicates that the project will create transportation system deficiencies in the impact area, improvements shall be recommended which shall include projected cost estimates. Costs estimates shall include right-of-way acquisition, utility relocation, and transportation facility design and construction. All cost estimates shall be approved by the City Engineer or their designee prior to acceptance of the TIA. The design of improvements shall be in accordance with specifications of this Code and other standards as may be adopted by the City and, where appropriate, TxDOT or the county. The mitigation plan shall also include provisions in the future for any dedications necessary to comply with the Minimum Road Standards described below. Where the final approval authority for any procedure determines that a mitigation plan is not adequate to address the traffic impacts of the project, it may serve as a basis for denial of the permit or subdivision plat.

8. Minimum Road Standards

- a. All applications for plat approval, site plan approval, zoning change or PUD zoning shall provide for adequate roads to support proposed development through compliance with the following minimum standards governing dedication and improvement of internal and adjacent thoroughfares. For purposes of this section "adjacent thoroughfares" shall include thoroughfares abutting the proposed subdivision or site development, whether located within the boundaries of the subdivision or within public rights-of-way.
- b. Dedication and Improvement of Internal and Adjacent Thoroughfares: For thoroughfares that currently are or will in the future be located alongside a property boundary, the

property owner shall dedicate and improve, as a minimum, one-half of the right-of-way necessary to meet the specification of future thoroughfares contained in the Comprehensive Plan or the City or County Thoroughfare Plan as adopted or amended by the City Council from time to time. The City may require additional land and improvements for rights-of-way for adjacent thoroughfares where necessary to achieve adequacy of the road network and where such additional land and improvements are proportional to the traffic impacts generated by the proposed development, depending on factors such as the impact of the development on the thoroughfare, the timing of development in relation to need for the thoroughfare, and the likelihood that adjoining property will develop in a timely manner. In the case of adjacent frontage or service roads for state and federally designated highways, the property owner shall dedicate sufficient right-of-way and make authorized improvements to provide an adequate road network to serve the development.

- c. Substandard Street Improvements: Where an existing thoroughfare that does not meet the City's right-of-way or design standards abuts a proposed new development, the City may require the property owner to dedicate the right-of-way for a standard thoroughfare width, and to improve the street according to the dimensions and specifications in this Code, depending on factors such as the impact of the development on the thoroughfare, the timing of development in relation to need for the thoroughfare, and the likelihood that adjoining property will develop in a timely manner.

#### 9. Participation in Costs and Completion of Improvements

- a. The City may participate in the costs of improvements required by this section to achieve proportionality between the traffic impacts created by the proposed development and the obligation to provide adequate roadways. In cases where the City determines participation is appropriate, the property owner shall be responsible for the entire initial costs of road improvements, including design costs. Reimbursement of the City's agreed share of the costs shall be made as funds become available. The construction of improvements and the provisions for participation in costs by the City shall be included in a subdivision improvement agreement.
- b. While providing for improvements, the City shall cooperate with the developer in the use of its governmental powers to assist in the timely and cost-effective implementation of improvements. Assistance shall not mean financial aid in actual easement acquisition, construction or engineering costs. Specifically, the City agrees to:
  - (1) Assist in the acquisition of necessary right-of-way and easements;
  - (2) Assist in the relocation of utilities;
  - (3) Assist in obtaining approvals from Bastrop County;
  - (4) Assist in obtaining approvals from TxDOT;
  - (5) Assist in securing financial participation for major thoroughfare improvements from Bastrop County, TxDOT or other area wide transportation planning and management entities as may be established in the future.

#### 10. City Evaluation and Action

- a. The City shall evaluate the adequacy of the TIA prepared by the applicant. Based upon such evaluation, the City shall determine:
  - (1) whether the application may be approved in the absence of dedication of rights-of-way or construction of improvements to each affected thoroughfare, and
  - (2) the extent of the applicant's obligations to make such dedications or improvements.
- b. The application for which a TIA is being conducted shall not be approved until the City has received all required payments or is otherwise satisfied with the financial arrangements related to required transportation improvements.



- c. The City shall condition the approval of the development application on one or more of the following acts by the applicant:
  - (1) Delay or phasing of development until thoroughfares with adequate capacity or intersection improvements are constructed;
  - (2) Reduction in the density or intensity of the proposed development sufficient to assure that the road network has adequate capacity to accommodate the additional traffic to be generated by the development;
  - (3) Dedication or construction of thoroughfares or traffic control improvements needed to mitigate the traffic impacts generated by the proposed development.

#### 11. Appeal of Road Mitigation Requirements

- a. An applicant may appeal a disapproved or denied final action resulting, in full or in part, from a determination that the Mitigation Plan was insufficient. The appeal shall first be presented to the Planning & Zoning Commission, for its consideration and decision. The decision of the Planning & Zoning Commission may be appealed to the City Council for a final ruling, which ruling shall be binding upon the City and the applicant, as it pertains to the Mitigation Plan and the development for which the Mitigation Plan was prepared. Applicants may appeal the decision of the City Council to a court of competent jurisdiction, as per the applicable provision in the Local Government Code, Chapter 212, et seq.
- b. Basis for Appeal
  - (1) The appeal must allege and demonstrate that recommended conditions requiring dedication or construction of thoroughfares or traffic control improvements are not roughly proportional to the nature and extent of the traffic impacts on the road network created by the development being proposed.
  - (2) The appeal may also allege and demonstrate that the imposition of the conditions deprives the owner of the economically viable use of the land, or of a vested property right.
- c. The appeal hearing body shall consider the appeal and determine whether the street or traffic control dedication and construction requirements are roughly proportional to the nature and extent of the impacts on the road network created by the development proposed. If the petition also alleges that the proposed dedication or construction requirements constitute a deprivation of economically viable use or of a vested property right, the hearing body also shall consider such issues. Following such determinations, the appeal hearing body may take any of the following actions regarding the road adequacy portion of the appeal:
  - (1) Deny the appeal, upon determining that the required dedications of rights-of-way for or improvements to thoroughfares or traffic control improvements are roughly proportional to the nature and extent of the impacts created by the development, and order that such dedication or improvements be made as a condition of approval of the subdivision or site development application.
  - (2) Deny the appeal, finding that the developer's proposed dedication or improvements are inadequate to achieve road adequacy, and either deny the subdivision or site development application or require that additional dedications of rights-of-way dedication for or improvements to thoroughfares, or traffic control improvements, be made as a condition of approval of the application.
  - (3) Grant the appeal and waive in whole or in part any dedication or construction requirement that is not roughly proportional; or
  - (4) Grant the appeal, and direct that the City participate in the costs of acquiring rights-of-way or constructing improvements sufficient to achieve rough proportionality.

12. Deferral of Obligation. Upon request of the applicant or property owner to the hearing body, the obligation to dedicate or improve thoroughfare rights-of-way or to make intersection improvements imposed on an application may be deferred to a later stage of the development process. As a condition of deferring the obligation to dedicate rights-of-way for or to improve thoroughfares, which deferral shall be in the sole discretion of the City, the City shall require the developer to execute a subdivision or site development improvement agreement specifying the amount and timing of the rights-of-way dedication or improvements to thoroughfares, including the posting fiscal surety, in a form and under terms acceptable to the City, in advance of approval of the development application.

### 13. Funding Options

- a. In lieu of the obligation to dedicate or improve thoroughfares or make traffic control improvements or post fiscal surety for subsequent construction to achieve road adequacy, the applicant may propose to make equivalent cash contributions based upon the development project's proportionate share of the costs of improvements, which the City in its sole discretion may accept in satisfaction of road adequacy standards in this section. Any funds accepted by the City shall be earmarked for construction of the improvements for which the contribution was made.
- b. Whenever the proposed development's share of the costs of a thoroughfare or traffic control improvement needed to mitigate traffic generated by the development is less than one hundred percent (100%), the City in its sole discretion may do the following:
  - (1) Participate in the excess costs; or
  - (2) Aggregate the costs of improving multiple thoroughfares or intersections identified in the TIA and require improvements to only some of the thoroughfares or intersections affected by the development.
- c. Advance Funding: If the landowners determine to either fund in advance or fund more than their pro-rata share, the City shall credit the developer's future fiscal posting. For those contributions and improvements beyond the developer's pro-rata participation, the City may either credit the developer's future fiscal posting or reimburse the developer out of City funds or funds allocated from other area landowners' contributions for those specific improvements.

D. Design Requirements. Design requirements are summarized in Tables 10-3. All streets shall have curb and gutter or grass-lined swales for drainage control. Curb, gutter and paving materials and methods for streets, unless otherwise specified, shall follow the Standard Specifications Manual for the City of Austin.

#### 1. Street Classification

Each street in the development must be classified for its intended purpose (see Section 10.32.005.A.1.a above). Streets shown on the Thoroughfare Plan shall be classified and designed to the functional classification shown on the Plan. Streets not shown on the Thoroughfare Plan shall be classified based on its intended use and the expected traffic volume. Functional classes include:

- a. Freeway: In Bastrop, State Highway 71 is the only thoroughfare classified as a Freeway and is under the design authority of the Texas Department of Transportation.
- b. Principal Arterial Divided or Undivided: A principal traffic artery, carrying higher volumes of traffic, more or less continuously, which is intended to connect remote parts of the area adjacent thereto and to act as a principal connecting street with State Highways.
- c. Minor Arterial Divided or Undivided: A minor arterial serves to connect with principal arterials and has a lower level of mobility.
- d. Collector: A street or road collecting traffic from other streets and collectors and serving as the most direct route to an arterial, State Highway, or a neighborhood center.

**Table 10-3—City of Bastrop, Texas  
Summary of Standards for Streets by Classification**

	Principal Arterials		Minor Arterials		
	PD6 Divided	PU6 Undivided	M4D Divided	M4U Undivided	Rural M4D Divided
1. Right-of-way width (feet)	120	110	90	80	90-120
2. Pavement width (feet) (face to face or ribbon curb to ribbon curb)	2-36	72	2-24	48	2-24
3. Minimum median width (feet)	16	n/a	14	n/a	16
4. Minimum pavement section <sup>1</sup>					
a. Stabilized subgrade (inches)	6	6	6	6	6
b. Asphalt/Concrete pavement (ins)	8	8	7	7	
5. Number of traffic lanes	6	6	4	4	4
6. Minimum Lane widths (feet)	11	11	10	10	10
7. Vehicle capacity policy (vehicles/hr:vehicles/day)	2,700/ 30,000	2,100/ 23,000	1,400/ 16,000	1,266/ 12,600	1,400/ 16,000
8. Design speed (mph)	40	40	35	35	35
9. Minimum grade (%)	0.5	0.5	0.5	0.5	0.5
10. Maximum grade (%) (Not to exceed 300 feet)	6	6	6	6	6
11. Minimum centerline radius (feet)	750	750	500	500	500
12. Stopping sight distance (feet)	500	800	500	800	500
13. Minimum spacing median opening (feet)	400	n/a	400	n/a	400
14. Minimum radius for curb returns at intersection (feet)	35	35	25	25	25
15. Reverse curve separation minimum (feet)	200	200	150	150	150

**Table 10-3 continued**

	Collector Streets	
	Urban	Rural
1. Right-of-way width (feet)	60	70
2. Pavement width (feet) (face to face or ribbon to ribbon)	36	26 plus 2-foot shoulder on cut side and 4-foot shoulder on fill side
2. Minimum pavement section <sup>2</sup>		
a. Stabilized subgrade (in)	6	6
b. Asphalt/Concrete pavement (in)	7	7
3. Number of traffic lanes	2 travel lanes, plus 2 parking lanes	2
4. Lane widths (feet)	10-foot travel lanes, 8-foot parking lanes	10
6. Vehicle capacity policy (Vehicles/hr:vehicles/day)	790/8,000	790/8,000
7. Design speed (mph)	35	35
8. Minimum grade (%)	0.5	
9. Maximum grade (%) (not to exceed 300 feet)	8	8
10. Minimum centerline radius (feet)	300	400
11. Stopping sight distance (feet)	300	300
12. Minimum median width (feet)	n/a	n/a
13. Minimum spacing median opening (feet)	n/a	n/a
14. Minimum radius for curb returns at intersection (feet)	25	25
15. Reverse curve separation minimum (feet)	75	75
16. Maximum foreslope/backslope	4:1/3:1	4:1/2:1

Table 10-3 continued

	Local Streets			
	One-Family Residential (curb&gutter)	Rural One-Family Residential (swale) <sup>2</sup>	Commercial, Industrial, and Multifamily	Rural Commercial, Industrial, and Multifamily
1. Right-of-way width (feet)	50	60	60	60
2. Pavement width (feet) (face to face or ribbon to ribbon)	26	24, plus 2-foot shoulders	40	40
2. Minimum pavement section <sup>2</sup>				
a. Stabilized subgrade (in)	6	6	6	6
b. Concrete pavement (in)	6	6	7	7
3. Number of traffic lanes	2	2	2	2
4. Lane widths (feet)	13	10	12	12
6. Vehicle capacity policy (Vehicles/hr:vehicles/day)	100/1,000	100/1,000	100/1,000	100/1,000
7. Design speed (mph)	30	30	30	30
8. Minimum grade (%)	0.4	0.5	0.5	0.5
9. Maximum grade (%) (not to exceed 300 feet)	10	10	10	10
10. Minimum centerline radius (feet)	200	300	300	300
11. Stopping sight distance (feet)	200	200	200	200
12. Minimum median width (feet)	n/a	n/a	—	—
13. Minimum spacing median opening (feet)	n/a	n/a	—	—
14. Minimum radius for curb returns at intersection (feet)	20	20	20	20
15. Reverse curve separation minimum (feet) and from curve to intersection (feet)	50/100	100/100	75/100	100/100
16. Maximum foreslope/backslope	4:1/3:1	4:1/3:1	4:1/3:1	4:1/3:1

## Notes:

1. The City Engineer may require a pavement design.
2. Rural design may be used on streets within the ETJ, and within the City upon approval by the City. Grass-lined swales designs shall be approved by the City Engineer.

boundaries shall be kept clear of fences, building, planting that would obstruct the flow of water, and other obstructions to the operations and maintenance of the drainage facility.

- e. Local Commercial/Industrial: A street or road intended primarily to serve traffic within an area of commercial and/or industrial development or proposed commercial and/or industrial development.

#### E. Street Cross-Sections and Pavement Width

1. Right-of-way widths: Additional Right-of-Way for County and State Highways. Provisions shall be made for the extension or widening of State and County highways, where required by the City to protect the safety and welfare of the public. Arterial streets having a right-of-way width of less than one hundred (100) feet, shall be increased to a one hundred (100) foot right-of-way for one hundred fifty (150) feet on either side of any intersection with another major street. The right-of-way shall be gradually and uniformly increased from the regular right-of-way width to the one hundred (100) foot width within an additional one hundred fifty (150) feet.
2. Pavement Widths. Streets shall be designed to the width required by the thoroughfare plan, Tables 10.3 or as may be specified by the City Engineer. All pavement widths shall be measured from the face of one curb to the face of the opposite curb or from the inner edge of a ribbon curb to the other inner edge of the parallel ribbon curb. Wider pavement widths shall be provided when required by the City Engineer to handle increased or unusual traffic conditions.

#### F. Street Alignment and Geometry

1. Design standards, unless specifically called out below, shall be standards that are found in common usage by the Texas Department of Transportation. Design guidelines shall follow the American Association of State Highway Transportation Officials (AASHTO) Geometric Design for Local Roads and Streets, and a Policy on Geometric Design of Rural Highways.
  - a. The geometric design of arterial streets shall conform to the formulas, principals, and guidelines of the American Association of State Highway and Transportation Officials (AASHTO), "A Policy on Design of Urban Highways and Arterial Streets".
  - b. The geometric design of rural neighborhood collector streets shall conform to the formulas, principals and guidelines of the American Association of State Highways and Transportation Rural Officials (AASHTO), "A Policy on Geometric Design of Highways and Streets", 1984 edition, or latest version.
2. Design Speeds. Unless otherwise approved by the city council, design speeds shall be in conformance with Tables 10-3. For use with Design Guidelines (Geometric Design Guide for Local Roads and Streets-AASHTO, 1984), design speeds for residential streets (rural and subdivisions) shall be assumed to be thirty (30) miles per hour and thirty-five (35) miles per hour for collectors, unless otherwise approved by the City. Design speed for higher type streets and main roads shall be those in Table 10-3, or State standard speed limits, unless otherwise approved by the City.
3. Street Alignment. A grid street pattern is preferred, unless topography or other factors dictate that curvilinear streets would be more appropriate. Streets should traverse the topography in the following manner:
  - a. Cross streams and drainageways at a right angle to minimize bridge and culvert costs;
  - b. Cul-de-sacs and loop streets should curve with the flow of the topography to best handle drainage;
  - c. Where possible, drainage should be away from the cul-de-sac or loop street toward the connecting street;
  - d. Property boundaries should not serve as the primary basis for street layout, with other property features (topography, soils, vegetation, etc.) serving as the overall guide.

4. Street Curves: Complete curve data (delta, length of curve, radius, point of curvature, point of tangency) shown on each side of the street; length of all tangents and dimensions from all angle points of curve to an adjacent side lot line shall be provided.

5. Vertical Alignment

- a. Changes in grades of over eight-tenths percent (0.8%) shall be connected by vertical curves.
- b. Minimum length (L) of vertical curves shall be fifty feet (50') or shall conform to the formula:

$$L = KA, \text{ (whichever is the greater)}$$

Where A is the algebraic difference in the tangent approach grades expressed as a whole number, and K is established in accordance with the Design Guidelines "Geometric Design for Local Roads and Streets," for sag and crest vertical curves, with credit given to the use of proper street lighting.

- c. Increased radius may be required where the street grades, street cuts, or other natural or manmade obstacles limit stopping sight distance on the curve to below that required by the design speed.
  - d. Super-elevation may be used to control surface drainage and centrifugal forces, but not to reduce the minimum centerline radius.
6. Horizontal Curves. Minimum and maximum horizontal curves shall be in accordance with Tables 10-3. These requirements may be made more stringent by the City Engineer if deemed necessary to provide minimum stopping distance, sight distance, design speeds, and other safety requirements consistent with good engineering practices.

G. Pavement Design

- 1. Pavement Design. To assure adequate and proper street pavements, a soils evaluation report by a licensed Engineer shall be required unless, in certain cases, the City Engineer gives a written determination that a report is not needed with reasons stated. All pavement designs shall follow the procedures and standards used by the Texas Department of Transportation or the American Association of State Highway and Transportation Officials for flexible and rigid pavements. This report shall be submitted with the plans and specifications for street improvements. As a part of the soils test for determining lime or cement content, the developer shall submit pavement designs by a qualified soil testing and pavement design Licensed Professional Engineer of the State of Texas. Total flexible pavement thickness (T.F.P.T.) design shall be based a soil type, traffic loading and a twenty (20) year minimum design life. The developer's engineer shall provide soil tests to determine by recommendation of a reputable soil testing laboratory the degree of lime stabilization of the subgrade is needed in conjunction with the reinforced concrete pavement. The recommendations shall address the percentage of lime to be applied. As a part of the soils test for determining lime or cement content, a pavement design shall be provided for arterials, industrial and commercial streets.
- 2. Pavement sections may be a combination of lime stabilization, crushed limestone base and hot mix asphaltic concrete, known as flexible pavement. Pavements may also be constructed of reinforced or jointed concrete paving, known as rigid pavement. Seal coat shall not be allowed as the wearing course for new construction. Generally, at a minimum, all streets shall be surfaced with one of the surfaces indicated below with curb and gutter as set forth below and built according to the current City of Bastrop Construction Standards Manual and Details.
  - a. Five (5) inches of reinforced concrete over six inches of lime stabilized subgrade.
  - b. Six (6) inches of hot mix asphaltic concrete over six inches of lime stabilized subgrade.

3. The City Engineer may require more stringent design requirements in locations of unusual soil or traffic conditions. In all cases, the developer's engineer shall conduct geotechnical tests which may dictate an increase in the pavement section. Any deviations from the typical sections shall require the approval of the City Engineer. The design shall be in accordance with AASHTO Guidelines and shall be based upon a twenty-year design life. A parabolic crown shall be provided in accordance with the city's standard details. The distance between expansion joints shall not exceed six hundred feet.
4. If lime stabilization is planned for subgrade, subgrade shall be tested for presence of sulfates, and if encountered, special provisions made to the overall pavement design.
5. All crushed limestone base material used shall be Texas Department of Transportation Item 247, Type A Grade 1 or better. The material shall be compacted in maximum six-inch lifts to a minimum of 97 percent of ASTM D 1557 Method D density at or near optimum moisture content.
6. Hot mix asphaltic concrete (HMAC) paving material shall be two inches (2") of Texas Department of Transportation Item 340, Type D over four inches (4") of Texas Department of Transportation Item 340, Type A. Asphalt shall be compact dense-grade hot mix with not more than five to nine percent (5 to 9%) in-place air voids. Asphalt content of the mixture shall not be increased to reduce pavement air voids. Liquid asphalt shall not exceed TxDOT Standards, as applicable as at date of application.
7. Concrete used for concrete pavements shall have a 28-day compressive strength of 3,600 PSI (5-1/2 sack) and a 14-day flexural strength of 500 PSI.
8. Subgrade beneath pavements to be constructed shall be free of vegetation, rocks over 3-inch diameter, and shall be processed to a depth of eight inches, and compacted to 95 percent of ASTM D 698, Method D density at optimum moisture.
9. Prepared subgrade shall extend two feet outside each edge of base course.
10. All subgrade and pavement materials shall be assigned a TxDOT Triaxial Classification (or equivalent if TxDOT Triaxial Classifications are no longer available or used) for design and City approval purposes.
11. Pavement designs shall be based on traffic counts and/or projections as follows:

Table 10-4

a.	Street Type	18-Kip Axle Repetitions
b.	Arterial	8,000,000
c.	Collector	Urban: 150,000
d.	Local	Residential: 42,000 Nonresidential: 120,000 Rural: 25,000

12. All materials furnished for the paving of streets and all construction methods shall fully conform to the appropriate sections of the Standard Specifications Manual for the City of Austin.

H. Curbs, Gutters and Road Margins (Shoulders)

1. Curbs and Gutters. Curbs shall be installed by the developer on both sides of all interior and perimeter streets. When using grass-lined swales, concrete paving shall include a six-inch wide by 12-inch deep beam along the edge of the pavement or a 6-inch wide by 12-inch deep ribbon curb when using asphalt pavement. When required for drainage, a six-inch high



barrier curb as part of a twenty-four inch (24") monolithic concrete curb and gutter shall be provided in accordance with the city's standard details.

2. The subgrade for curb and gutter typically shall consist of six inches of lime or cement-stabilized base material. In cases where lime stabilization is not feasible, six inches of mechanically compacted crushed stone or six inches of two sack concrete ("2:27") may be used as base material. The stabilized base must extend six inches beyond the curb and gutter.
  3. For concrete streets, the curb and gutter shall be constructed monolithically in accordance with the city's standard details and standard specifications. Concrete shall be five-sack, three thousand six hundred pounds per square inch (3,600 psi) design with two (2) #3 steel bars placed longitudinally with the curb and gutter. Joints shall be scribed in the curb and gutter at distances no greater than twelve feet and expansion joints placed at each radius or linear distances of two hundred fifty feet or less. Any pavement damaged during curb and gutter installation must be restored to meet city specifications.
  4. All improvements shall be subject to inspection and approval of the City Engineer. All work shall be subject to tests as prescribed by the City Engineer, with the cost of such tests borne by the developer or their contractor. If a test fails to meet specifications, the contractor shall bear the expense of removing the faulty section delineated by the City Engineer, reconstructing the section, and performing any subsequent tests required by the City Engineer.
  5. Wheelchair ramps shall be provided at all street intersections, unless otherwise approved in writing by the City Engineer. Wheelchair ramps shall also be provided at driveway curb returns where the location of the curb return intersects the sidewalk and results in a barrier to handicapped access. Wheelchair ramps shall be provided in commercial and industrial parking lots that are required to provide handicapped parking spaces. All wheelchair ramps shall be constructed in accordance with the city's standard details and in compliance with ADA requirements.
- I. Intersections
1. Intersections should have only two streets intersecting at right angles. This provides the safest type of intersection. Other types of intersections include:
    - a. Four-way Intersections. Four-way or cross intersections are discouraged except where such an intersection is determined as desirable by the City from the standpoint of access, traffic flow, or safety.
    - b. "T" Intersection. These are useful for discouraging through traffic and should be used when more than one hundred fifty feet away from any other intersection. Use "T" intersections rather than four-way intersections and intersect all streets at ninety degrees (90'). A tangent section of sixty feet (60') at right angles to the street being entered by an intersecting street shall be designed prior to any curve radius on the entering street.
    - c. "Y" Intersection. These occur when three streets intersect at a common point. "Y" intersections shall not be permitted.
    - d. Roundabouts. Roundabouts may be used for low-volume intersections with little expected truck traffic. Where permitted, roundabouts shall be designed using the Texas Roundabout Guidelines (Center for Transportation research, the University of Texas at Austin, Project 0-6414, August 2011) and/or Roundabouts: An Informational Guide, Second Edition by the Federal Highway Administration (National Cooperative Highway Research Program Report 672, 2010).
  2. Intersections shall be designed for the control of traffic generated by the project, control of existing traffic that might use the project for access to some other area, and the future safety of the public.

3. Intersections shall be designed to as near right angles as possible and in no case shall vary from ninety degrees (90) by more than five degrees without specific authorization by the Planning and Zoning Commission. Curb returns at intersections shall be in accordance with Tables 10.1. If the intersection angle between any two streets varies by more than five degrees from a right angle, the minimum curb return shall be determined and approved by the City Engineer. Acute angles between streets in subdivisions at their intersection shall be avoided, provided that when intersecting angles sharper than eighty degrees (80') are deemed necessary by the City, the property line in the small angle of the intersection shall be rounded to permit the construction of curbs having a radius of not less than twenty-five feet (25') without decreasing the normal width of the sidewalk area. Curbs at acute angle intersections, if approved, shall have twenty-five (25) foot radii at acute corners.
4. Wherever possible, street jogs with center line offsets of less than one hundred fifty feet (150') shall be avoided. No street jogs or offsets are permitted for collector or arterial streets.
5. Intersection spacing:
  - a. The spacing of Rural Neighborhood Collector Streets shall not be less than one thousand three hundred feet (1,300'), unless sight-distance or topography dictates a lesser street spacing, [and] left and right turning lanes shall be provided at street intersections to reduce the effect of turning vehicles on through traffic.
  - b. Rural Arterial Streets Arterial Streets shall primarily provide movement of vehicular traffic from neighborhood collector streets and industrial streets to State and County highways.
    - 1) To promote the movement of traffic on arterial streets, the spacing of signalized street intersections on rural arterial streets shall not be less than two thousand six hundred feet (2,600') unless approved by the City upon consideration of a traffic study prepared by a qualified traffic engineer. In general, the spacing of street intersections along an arterial shall not be less than one thousand three hundred feet (1,300'), unless sight-distance or topography dictates a lesser street spacing.
6. Grades. Approach grades on an intersecting street should be limited to three percent (3%) for at least fifty feet (50') unless sight distances are more than the AASHTO Design Guide minimums for stopping on grade level, in which case the approach grades should not be greater than six percent (6%).
7. Major Intersections. Streets intersecting Federal routes, State highways, or Farm to Market roads shall require approval of the Texas Department of Transportation.
8. Intersections of Curbed Streets with Uncurbed Streets. Curbed to uncurbed street intersections shall be designed with appropriate concern for the interfacing of the differing drainage systems.
  - a. Where a curbed street intersects a continuing uncurbed street, standard curb and gutter shall terminate at the property line or as necessary to allow drainage from the curbed street to enter the uncurbed street bar ditch without erosion to shoulder areas. Concrete riprap or mortared rock riprap may be required to protect the shoulder area.
  - b. Where an uncurbed street intersects a continuing curbed street, the curb line shall be cut and removed and a standard urban curb return designed into the uncurbed street with the curb face at the ditch centerline of the uncurbed street. A concrete riprap transition shall be constructed to convey drainage out of or into the uncurbed ditch line. The concrete riprap transition may be eliminated for discharge into the uncurbed street from the curbed street if transition grades are less than two percent (2%) or if an inlet is located within one hundred feet (100') of the intersection. For drainage from uncurbed street into the curbed street, for grades less than five percent (5%) on the uncurbed street, two ditch checks at ten feet (10') and thirty feet (30') from end of curb return may be used in lieu of riprap transition.

- c. Care shall be taken in installation to match existing pavement. Curbed street crown will be full crown (unless cross spilling) to at least fifty feet (50') from curb and to assure flow of drainage enters bar ditch.
  - d. For a curbed street discharging into uncurbed street, surface drainage that has been carried by the curb and gutter from a point more than one hundred feet (100') from the intersection with the uncurbed street shall be removed using inlets draining to the drainage pipe required at the intersection so as not to interrupt the flow of drainage in the bar ditch of the uncurbed street.
  - e. The above item may be deleted if the surface drainage from the urban street can be directed from the ends of the curb and gutter to the bar ditch of the street without surcharge of the curb and gutter, provided there is no reduction in carrying capacity and provided adequate erosion control can be maintained.
  - f. Each new street intersection with, or extending to meet, an existing street, shall be tied to the existing street on center line.
9. Visibility triangles shall be provided at all street intersections, either as dedicated right-of-way or as a public open space easement. The minimum triangle shall be that provided in Section 10.36.020.D, though additional open space easement may be required when necessary to achieve the necessary sight distances. The city shall use the sight distance requirements established by the Institute of Transportation Engineers' Guidelines for Urban Major Street Design (1990) in making its determinations.

Entrance Safety. A street may not intersect a County road at a point where the sight distance is restricted to less than five hundred feet (500') except upon the basis of a traffic engineering investigation, unless provision is made (with copies of all pertinent agreements thereto) for removal of the sight restrictions.

J. Dead-End Streets, Cul-De-Sacs, One-Way Streets and Private Streets

- 1. Dead-end Streets. Dead-end streets shall be prohibited except as short stubs to permit future street extensions. Dead-end streets may be platted where the land being subdivided adjoins property not being subdivided, in which case the streets shall be carried to the boundaries thereof. Such short stubs longer than one hundred thirty feet (130') in length shall be provided with an approved turnaround having a minimum radius of fifty feet. Temporary dead-end streets shall have provisions for future extension of the street and utilities and, if a temporary cul-de-sac is utilized, a reversionary right to the land abutting the turn-around for excess right-of-way shall be provided.
- 2. Temporary turnarounds are to be used at the end of a street more than one hundred thirty (130) feet long that will be extended in the future. The following note should be placed on the plat: "Cross-hatched area is temporary easement for turnaround until street is extended (direction) in a recorded plat." When the Planning and Zoning Commission determines that there is a reasonable expectation that a dead-end street will be extended within two years, construction of a temporary cul-de-sac may be approved. The Planning and Zoning Commission may waive temporary cul-de-sac requirements for dead-end streets when the street is less than two hundred feet in length. The portion of the temporary cul-de-sac which will serve as an extension of the street shall be constructed in accordance with the city standards and that additional portion of the temporary cul-de-sac shall be in accordance with the city standards for a permanent cul-de-sac. "Adequate, all-weather turnaround" is defined as a turnaround that is of sufficient size to accommodate fire and sanitation vehicles and is of a construction quality comparable to standard road cross sections.
- 3. Cul-de-sacs. Streets designed to be permanently dead-end shall not be longer than two hundred (200) feet and shall be provided at the closed end with a paved cul-de-sac at least eighty (80) feet in diameter on a street right-of-way of at least one hundred (100) feet in diameter. Cul-de-sacs and loop streets should drain to other streets, if possible.

- a. Cul-de-sacs on a rural residential street shall not provide access to more than twenty (20) lots and shall provide turnarounds with sixty feet (60') of right-of-way and forty feet (40') of pavement radius. Pavement radii at intersections shall be a minimum of twenty-five feet (25').
  - b. A cul-de-sac on a rural Industrial street shall provide a turnaround with eighty feet (80') right-of-way radius and sixty feet (60') pavement radius.
4. One-Way Streets. Unless otherwise approved by the city planner, one-way streets are prohibited in the city.
5. Partial or Half-Streets: Partial or half-streets may be provided where the City Council determines that a street should be located on a property line.
6. Private Streets, Gated Communities and Common Area Regulations.
- a. Intent and Purpose. It is the intent of these private street and common area regulations to:
    - (1) Allow private street developments to occur within the City of Bastrop on a limited and restrictive basis;
    - (2) Provide for private street developments as one type of residential development alternative to allow the city of Bastrop to expand housing types.

There shall be no required minimum or maximum acreage size and/or number of lots within private street developments; however, minimums and maximums will be evaluated on a case-by-case basis by the Planning and Zoning Commission.

The location of each private street development will be subject to the approval of the planning and zoning commission on a case-by-case basis, based upon, among other matters, the criteria described in this chapter. An applicant who meets the stated criteria will not be entitled to the private street subdivision as a matter of right but shall only obtain approval for the private street subdivision at the sole discretion of the Planning and Zoning Commission, after review by city staff. Denial of approval of any private street development by the Planning and Zoning Commission shall be final and shall not be reviewable by the Bastrop City Council or Zoning Board of Adjustment.
  - b. Compliance with Other Laws. To qualify for consideration of private streets, the applicant must satisfy the criteria of the city of Bastrop comprehensive plan, the City of Bastrop zoning ordinance, as amended; the city of Bastrop subdivision ordinance as amended; and any other applicable codes and ordinances, as may be, from time to time amended.
  - c. Guidelines for Development. The following guidelines are to be satisfied as part of the review and approval process for all private street developments:
    - (1) The area must be within the corporate limits of the city of Bastrop, or within the Bastrop Extraterritorial Jurisdiction;
    - (2) The area shall be a proposed residential development, and shall be zoned solely as a residential zoning district (that is, a zoning district the stated purpose of which is to provide for primarily residential uses), except in the case of a planned development (PD) zoning district, in which case the area must be designated solely for residential use;
    - (3) Only the following zoning districts within the City shall allow consideration of private street developments:
      - Single Family (SF 20, SF 9 or SF7)
      - Multiple Family (MF-1, or MF-2)
      - PD - Planned Development District;

- (4) The area may not impede a current or future development of a thoroughfare, or otherwise adversely affect connectivity;
- (5) The area may not disrupt an existing or proposed city of Bastrop public pedestrian pathway, hike and bike trail or park.

d. General Requirements.

- (1) The private street system must comply with design standards in the Bastrop subdivision ordinance. All rules and regulations in the subdivision ordinance to "public right-of-way" shall apply to private street lots, including right-of-way and street width and paving requirements, sidewalk and street lighting requirements. The commission will entertain proposals for creative quality alternative streetscape developments that achieve the goals of adequate vehicle and pedestrian access.
- (2) The private street system shall provide perpetual access for police and other emergency vehicles, public and private utility maintenance and service personnel, solid waste collection services, the U.S. Postal Service, and government employees in pursuit of their official duties.
- (3) The type of gate or controlled access mechanism is subject to the approval by the city of Bastrop's fire marshal, and any corrective action shall be the responsibility of the property-owners association. The city of Bastrop shall bear no responsibility or liability in connection with the removal or destruction of any gate or other controlled access mechanism while engaged in an emergency action.

e. Specific Requirements.

- (1) Each private street development plat shall contain the following wording on the face of the plat. "The streets have not been dedicated to the public, for public access nor have they been accepted by the city of Bastrop as public improvements, and the streets and roadways shall be maintained by the property owners association within the subdivision, except that the streets and roadways shall always be open to emergency vehicles, public and private utility maintenance and service personnel, solid waste collection services, the U.S. Postal Service, and governmental employees in pursuit of their official duties."
- (2) All private street developments will be approved concurrent with the final plat. The planning and zoning commission shall consider the private street development after review and recommendation by the city staff.
- (3) Easements. Private street developments shall provide the following easements:
  - (a) "Public utility, drainage and storm sewer" easements containing private streets and public utilities;
  - (b) Additional public utility assessments required by public agencies;
  - (c) Pre-existing easements unaffected by the platting process; and
  - (d) Such private service easements, including, but not limited to, utilities, fire lanes, streetlighting, government vehicle access, mail collection and delivery access, and utility meter reading, access, as may be necessary or deemed mutually convenient by the applicant and the city.
- (4) Access. To insure adequate access to each subdivision, there should be at least two points of ingress and egress, except for approved cul-de-sacs. The second entry may be designated for emergency access only.
- (5) Private Access Amenity Plan. For each private street development, a private access amenity plan shall be submitted to the city planner for review and approval in consultation with public safety and other city departments. At a minimum, the private access amenity plan shall include a scale drawing showing the plan and profile of all

walls, gates, entry areas, landscaping, architectural features, and signs, etc. This will provide opportunity to review proposed controlled access mechanisms, access points, landscaping, screening walls, or similar buffering barriers, and other related private street components.

- (6) The city staff may request rendered perspectives and elevations of proposed structures, including description of proposed building materials, roof pitches, signage, and showing relationships to adjacent structures and such other items as the city staff might reasonable request (such renderings of elevation of proposed structures does not refer to residential structures, but rather to other structures that are components of the private street development).
  - (7) The city staff may require additional data to amplify and clarify the private access amenity plan; such information may include, but not be limited to, fencing, access controllers, entrance areas, barriers, perimeter walls, and exterior landscaping.
  - (8) No credit will be allowed for the development of private parks, not open to the public, except as may be provided in Section 10.08.020.G of this code.
  - (9) Except as may otherwise be provided in a PD-zoning approval, building lines shall be provided in accordance with the zoning ordinance from the edge of the private street lot.
- f. Conversion of Public Streets to Private Streets. For existing subdivisions with public streets and rights-of-way to become private, the following procedures shall apply:
- (1) The permit application must contain the signatures of all the owners of the lots that would be part of the proposed private street subdivision.
  - (2) The street right-of-way must be purchased from the city in accordance with Chapter 272 of the Texas Local Government Code. The Planning and Zoning Commission shall first review the application and forward a recommendation to the City Council. If the recommendation is favorable and the City Council concurs, the City Council shall order an appraisal of the street rights-of-way in the affected subdivision. The cost of such appraisal shall be borne by the applicants, and the appraisers conclusion of value shall be final.
  - (3) Once the conversion takes place, all other provisions of this chapter shall be applicable to the private street subdivision.
- g. Relationship to the Comprehensive Plan. The following components shall be evaluated when reviewing potential private street developments. This evaluation will aid in logical implementation of the current city of Bastrop comprehensive plan and the following components may be hereafter amended.
- (1) Future Land Use Plan. Development impact on land uses, their configuration and function shall be examined as part of each request for a private street development.
  - (2) The Master Park Plan. The proposed private street development shall be evaluated to assess impact of private streets on access, including ingress and egress, and continuity of the hike/bike/jogging/open space linkage system within the community, as well as the functioning of other park plan and trail system plan elements of the comprehensive plan.
  - (3) Thoroughfare Plan. The proposed private street development shall be evaluated to assess its impact on the efficiency, convenience, and safe functioning and implementation of the thoroughfare plan element of the comprehensive plan.
- h. Public Improvement Districts and Property Owners Associations.
- (1) Public Improvement District Required. Developers proposing subdivisions with private streets shall petition the city council for the creation of a public improvement district to maintain the private streets as provided in Chapter 372 of the Local Government Code. If the proposed development is adjacent to an existing public

improvement district, the developer shall petition to be added to the preexisting district.

- (2) Property-Owners Association. In lieu of the public improvement district and upon approval of the Planning and Zoning Commission, subdivisions with private streets and/or common areas and facilities may have an approved property-owners association. The property-owners association shall require membership by all property owners within the subdivision and have provisions to assess and/or place liens on owners for nonpayment of street and common area maintenance dues. The property-owners association shall own and be responsible for the maintenance of private streets, appurtenances and common areas and facilities. The property-owners association shall provide for the payments of dues and assessments required to maintain the private streets and common areas. The property-owners association covenants and bylaws shall be approved by the city staff and city attorney. The approved document must be filed for record contemporaneously with the filing of the final plat in the county records department.
- (3) Street and Common Area Maintenance Reserve Fund. The property-owners association covenants and bylaws shall establish a Street Maintenance Reserve Fund for the maintenance, repair and reconstruction of private streets, access-controlled structures and equipment and common areas and facilities. This reserve fund shall not be co-mingled with any other property-owners association funds. Each property owner shall be assessed annually to be placed in the Street and Common Area Maintenance Reserve Fund. After five (5) years of existence, the accumulated balance of the fund shall not be less than five dollars per front foot of each lot. The formula for calculating the reserve fund may be reviewed and amended as needed upon approval by the city. The property-owners association shall provide the city an audited statement of the fund's balance, upon request.
- (4) The property-owners association's covenants shall contain provisions that allow the city of Bastrop to assume the duty of performing the maintenance obligations should the property-owners association dissolve or in any way fail or refuse to maintain its obligations. The covenants shall further provide that the city of Bastrop may use the outstanding balance in the Street and Common Area Maintenance Reserve Fund for maintenance or in the alternative, levy an assessment upon each lot on a pro rata basis for the cost of such maintenance.
- (5) Membership Requirements. Every lot owner within the development shall be a member of the property-owners association.
- (6) The property-owner's association documents shall indicate that the streets within the development are private, owned and maintained by the property-owners association and that the City of Bastrop has no obligation to maintain or reconstruct the private streets or common areas and facilities. The covenants shall include the following provision.

"The property owners association shall be responsible for contacting the City of Bastrop Planning Department every two (2) years, or as needed, from time of construction to schedule an inspection by city staff and/or their designee of the private streets or private roadways and common areas and facilities."
- (7) The property owners association covenants and bylaws shall include language, approved by the city attorney, whereby the association agrees to fully indemnify, hold harmless and defend the city, its officers, agents, and employees, from any and all claims, lawsuits, judgments, costs or causes of action of any nature whatsoever, whether real or asserted, brought for or on account of any injuries or damages to persons or property including death, resulting from or in any way connected with the construction, maintenance or operation of the private streets and common areas and facilities.

i. Conversion of Private Streets to Public Streets.

(1) Voluntary Conversion. The city of Bastrop may, but is not obligated to, accept private streets for public access and maintenance. The procedure must conform to the following provisions:

- (a) The property-owners association must submit a petition signed by one hundred percent of its members;
- (b) All of the streets and roadways must be in a condition that are acceptable to the city of Bastrop;
- (c) All access controllers and other structures not consistent with a public street development must be removed;
- (d) If any maintenance of the streets and roadways is required, the city of Bastrop may use the outstanding balance in the reserve fund for such maintenance. Any remaining balance in the fund shall be returned to the lot owners at the time the private street and/or roadway is converted back to a public street on a fair and equitable basis to be determined by the city council.
- (e) Each lot owner shall execute an instrument of dedication for filing of record, the form of which shall be approved by the City Attorney's office.

j. Design Standards. The design and construction of the infrastructure within a private street subdivision shall conform to the same rules, regulations, standards, and specifications established for public subdivisions. The City Manager or his or her designee is authorized to promulgate rules, regulations, standards, and specifications for the design and construction of improvements unique to a private street subdivision. The same shall be filed with the City Secretary at least thirty (30) days before they shall become effective. An amendment may be made from time to time, provided that the amendment is filed with the City Secretary at least thirty days before it becomes effect. No such rules, regulations, standards or specifications shall conflict with this or any other ordinance of the City of Bastrop.

(1) Structures.

- (a) Project perimeter fences at project entry access points, entry monuments, and access controllers, may be erected within the public utility, drainage and storm sewer easement(s), provided they do not impede the installation, maintenance, repair, or replacement of public utilities and storm sewers within the easement.
- (b) Where access controllers are a part of a larger, multipurpose structure, only that portion of the structure which functions as access controllers may encroach the building line adjacent to the private street.

k. Streetlights on Private Streets. The developer shall submit a streetlighting plan for review and comment by the city staff. Streetlighting shall generally conform to the standards in Section 10.36.080, though alternate poles and luminaries may be used that achieve the same level of illumination. It shall be the responsibility of the property-owners association to pay for the cost of operating the streetlights on private streets.

K. Roadside Drainage

- 1. Drainage: Adequate drainage shall be provided with paved sections or by swales to drain all lots to streets without drainage easements through lots where possible. The depth of swale shall be as required for drainage with a minimum longitudinal slope of one-half (1/2) of one (1) percent toward a street or drainage easement.
- 2. Roadside Swales and/or Drainage Ditches: Roadside drainage ditches shall conform to the following:



- a. Minimum grade - 0.5%
- b. Maximum grade in sandy soils - 5%
- c. Maximum grade in clay soils - 8%
- d. All open swales, channels, bar ditches or other drainage ways shall have a minimum velocity of two feet per second.
- e. Maximum velocities:
  - a. coarse sand - 4 feet per second
  - b. fine gravel - 6 feet per second
  - c. sandy silt - 2 feet per second
  - d. clay - 3.5 feet per second
  - e. grass-lined sandy silt - 6 feet per second
  - f. silt clay - 8 feet per second
  - g. poor rock (usually sedimentary) - 10 feet per second
  - h. soft sandstone - 8 feet per second
  - i. soft shale - 3.5 feet per second
  - j. good rock (usually igneous or hard metamorphic) - 12 feet per second
  - k. reinforced concrete lining - 15 feet per second
- 2. Roadside design details include rock retards, riprap retards, entrance and exit structures for culverts, special design roadside ditches, retaining walls, etc.
- 3. Rock or riprap retards shall be used to control the erosive characteristics of drainage in roadside ditches on steep slopes. Retards shall be designed to reduce drainage water velocity to an acceptable level and to prevent drainage water from encroaching on the driving surface. Retards shall not project onto shoulder surfaces and shall blend into ditch lines so that normal roadside ditch maintenance is possible.
- 4. Headwalls, catch basins or other culvert structures shall be designed in accordance with the drainage requirements of these specifications and the Typical Construction Details of the Texas Department of Transportation or these specifications whichever is applicable. No headwall, wingwall or other structural member shall protrude above the surface of the traveled roadway. Flush headwalls at three to one (3:1) maximum or flatter slopes are preferred for any culverts parallel to streets (driveways, etc.).
- 5. All special design of roadside ditches, retaining wall, etc., require the specific approval of the City.
- 6. All grass-lined drainage systems, including bar ditches shall be seeded per TxDOT ROW vegetation standards Item 164, and developer shall make provisions to establish vegetation per EPA Storm Water Pollution Prevention Plan.
- 7. Developer shall submit a Notice of Intent and Storm Water Pollution Prevention Plan.
- 8. Drainage Culverts and Bridges. Design of structures of this nature shall conform to the Texas Department of Transportation Standard Specifications for Construction of Highways, Streets and Bridges, latest revision.
- 9. Culvert and bridge design loading and widths for roads and streets shall conform to the Texas Department of Transportation standards. Bridge widths shall conform to Design Standards for Farm to Market Roads, secondary roads division, TDOT, or as directed by the City. Structures of this nature require the specific approval of the City. All street and road

culverts shall be constructed of reinforced concrete box culverts or reinforced concrete pipe culverts.

#### L. Alleys

1. Pavement Type: All alleys shall be paved with asphalt or reinforced concrete conforming to street paving requirements.
2. Alley Width: For alleys serving single family areas, a minimum paved width of sixteen (16) feet and a minimum right-of-way of sixteen (16) feet shall be required for all alleys.
3. Alleys may be provided in commercial and industrial districts where other definite and assured provisions are not made for service access, such as off-street loading, unloading, parking and firefighting access consistent with and adequate for the uses proposed. All alley paving shall be constructed in accordance with city standards. Alleys shall be approximately parallel to the frontage of the street and shall be less than one thousand six hundred feet in length unless specifically approved by the Planning and Zoning Commission. Alleys in commercial and industrial areas shall have a minimum right-of-way and pavement width of thirty feet and a minimum pavement thickness of seven inches of reinforced concrete pavement or eight inches of HMA over six inches of lime or cement-stabilized subgrade. A pavement design shall be provided by the developer for commercial and industrial alleys. The minimum inside radius of any curve shall not be less than twenty feet.
4. Intersecting Alleys or Utility Easements. Where two alleys or utility easements intersect or turn at a right angle, a cut-off of not less than ten feet (10') from the normal intersection of the property or easement line shall be provided along each property or easement line. In cases where two alleys intersect or turn a sharp angle, lot corners shall be platted so that a triangular area of twenty-five feet by twenty-five feet (25' by 25') or greater, is dedicated as part of the alley for providing a minimum radius of thirty feet (30') to the inside edge of the alley paving.
5. Dead-End Alleys. Dead-end alleys shall not be permitted.
6. Turnouts. Alley turnouts shall be paved to the property line and shall be at least twelve feet wide at that point. The paving radius where an alley intersects an arterial shall be twenty feet and shall be ten feet at intersections with all other streets.
7. Alleys should intersect streets at right angles or radially to curved streets.
8. Alley paving should have a minimum grade of 0.4 percent and a maximum grade of ten percent.

#### M. Driveways

1. Number of Direct Access Driveways (Curb Cuts). Each landowner is entitled to access to the city street and thoroughfare system; however, it is city policy to limit the number of driveways entering streets and thoroughfares to protect public safety and maintain traffic efficiency. Therefore, each landowner is entitled to only one driveway for each lot or parcel. Additional drive approaches shall be approved only when it has been determined that the additional driveway is necessary for adequate traffic circulation and that street efficiency and safety are preserved. Circle drives on one-family lots fronting on local streets will be generally permitted when the City Engineer determines that traffic safety is not hindered. Additional driveways other than above will be allowed under the following conditions:
  - (1) If the daily volume using one driveway would exceed five thousand vehicles (both directions);
  - (2) If the on-site, peak-hour traffic volume exceeds five hundred vehicles per hour (both directions);
  - (3) A competent professional traffic analysis shows that traffic conditions warrant more driveways. Part of this study must include data indicating volumes

compared to above standards and must show how alternative arrangements, joint access, etc., will not work.

2. Location. The location of driveway ingress or egress from any lot onto a collector or arterial shall be approved by the City Engineer. Driveways shall provide a minimum of twenty feet (20'), or the front yard setback, whichever is greater, between the property line and any garage door, gate, or other obstruction to provide for safe parking or stack space from of the public right-of-way. The location and size of all driveways serving multi-family residential, commercial and industrial properties shall be subject to the approval of the City Engineer. The City Council shall promulgate design standards for such facilities.
  - a. Driveways accessing lots with frontage widths of less than sixty feet (60') shall be restricted to alleys.
  - b. Driveway access to lots having frontage on more than one street shall be limited to the street having the lesser classification. Driveway access to collector and greater streets is prohibited, provided the City Engineer may make exceptions for unusual circumstances.
  - c. Residential Driveway Access to Arterial Streets. Residential driveway access to arterial streets should not be permitted except for major multiple-family "cluster" developments. It is the policy of the city to discourage driveway cuts onto the major arterials of the city. Driveway cuts onto the city's major streets will be allowed only when:
    - (1) There is no other feasible alternative; or
    - (2) Traffic engineering studies clearly show a need.
  - d. Rear and side driveway access to major and collector streets shall be prohibited.
  - e. Driveways accessing lots from state or county roads, with average daily trip volumes greater than two thousand (2,000) vehicles, shall conform to standards set forth in the TxDOT Access management manual and as described in the city Construction Standards Manual.
3. Proximity to Intersections: Driveways shall be located the maximum possible distance from street intersections. No driveway shall be located within two hundred feet (200') of the intersection of an arterial with an arterial, one hundred twenty-five feet (125') of the intersection of an arterial and a collector, one hundred feet (100') for a rural industrial street, or seventy-five feet (75') of a street intersection of a collector and local or within fifty feet (50') of a local and local street unless no other point of access can be provided. Likewise, driveways shall be located a minimum of seventy-five feet from any median opening unless the median opening directly serves the driveways. Deviations from these standards shall be allowed only upon approval of the city planner. Except for residential driveways on local streets, driveways should be located directly opposite each other to minimize the potential points of conflict. No driveway shall be constructed within the curb return of a street intersection or within the radius of the edge of pavement or traveled roadway at an intersection on a curve.
  - a. Rural arterial streets shall provide access to major traffic generators. The number and location of driveways to arterial streets shall be determined by the City upon consideration of the impact on traffic movement and safety. In general, driveways along arterials to major traffic generators shall not be closer than three hundred feet (300') to a street intersection and shall provide high driveway design standards including acceleration and deceleration lanes. Roadway margins along arterials shall be clear of buildings within twenty-five (25') of the right-of-way line.
  - b. Driveways entering onto access roads of controlled access highways shall be prohibited for a distance of one hundred feet before the intersection of roadway surfaces on exit ramps to a point located three hundred feet (300') after the intersection of the travel lanes. Driveways are prohibited for a distance of one hundred feet before the intersection of travel lanes on any entry ramp to a point located one hundred feet (100') beyond the

intersection of roadway surfaces and otherwise meet or exceed all other requirements of the Texas Department of Transportation.

4. Number and Minimum Spacing Between Driveways:

The minimum separation between drive approaches shall be in accordance with Table 10-5.

On driveway access to any public road or street, a maximum of two driveways will be permitted to any property with more than two hundred feet (200') of adjacent right-of-way frontage (i.e. 400 feet total frontage or more). If total right-of-way frontage is two hundred feet (200') or less, driveway access will be limited to one access only. Where dip-type driveway installations are used, two driveways per lot will be allowed regardless of lot frontage. The use of circular driveways may be approved on a case-by-case basis by the City Engineer after evaluating the traffic safety of adding the additional drive approach.

Table 10-5

Street Classification	Separation of Curb Cuts
Primary Arterials (P6D)	One per 300 feet of frontage
Secondary Arterials (M4U)	One per 200 feet of frontage
Collector (RC)	One per 100 feet of frontage
Rural Collector	One per 300 feet of frontage
Local (residential)	10-foot separation unless joint access
Rural Residential Local	One per 150 feet of frontage
Rural Industrial	One per 200 feet

5. Width, Length and Construction of Driveway Approaches.

- a. Residential Driveway Width. Residential driveways to serve single car garages, carports, and/or storage areas shall not be less than ten feet (10') nor more than twenty feet (20') in width, measured at the property line. Residential driveways to serve two car garages, carports, and/or storage areas shall be not less than ten feet (10'), and not more than twenty-four feet (24') in width, measured at the property line. When residential driveways are required to serve three or more car garages, carports, and/or storage areas, the size and location of the driveway(s) shall be subject to the approval of the City Engineer, after an adequate engineering analysis of the parking, maneuvering and access requirements. A driveway should not begin less than five feet (5') from the point of tangency of the corner radius of an intersection. Alternate driveway widths, such as narrow two-track drives, may be approved on a case-by-case basis by the City Engineer.
- b. Residential Driveway Length: Driveways shall provide a minimum of eighteen feet between the property line and any garage door, gate, or other obstruction to provide for safe parking or stack space from the public right-of-way. Roadway margins along residential streets shall be clear of buildings within twenty-five feet (25') from the right-of-way line. Roadway margins along a collector street shall be clear of buildings within twenty-five feet (25') of the right-of-way line.
- c. Width of Multi-Family and Commercial Driveways - Multi-Family residences and commercial uses shall have driveway pavement widths of twenty feet (20') minimum and thirty-foot (30') maximum, and a twenty-four-foot (24') minimum for two-way driveways. Driveways should not exceed sixty-five percent of the property frontage.
- d. Building setback for rural industrial street: Roadway margins along industrial streets shall be clear of buildings within twenty-five feet (25') of the right-of-way line.

- e. Radius: Driveway pavement radii shall be a minimum of five feet (5') into curbed streets and minimum of ten feet (10') into uncurbed streets and shall be a maximum of fifteen feet (15') for either curbed or uncurbed driveways. If permitted, low density residential driveways entering onto collector or arterial streets shall have a minimum curb return radius of ten feet (10'). The minimum radius of a commercial, industrial or multi-family residential driveway shall be ten feet, but twenty feet may be required in most locations.
  - f. Construction: All drive approaches must be paved with concrete within the street right-of-way. Beyond the right-of-way line, driveways shall be paved with a permanent pavement (asphalt or concrete or otherwise having an City-approved all-weather and dust free surface). Driveway pavement in the street right-of-way shall be a minimum six inches of crushed limestone base and five inches (5") of concrete. Replacement of existing asphalt drive approaches may use two inches (2") of hot mix asphaltic concrete in lieu of Portland cement with the approval of the City Engineer. Driveway base shall be two feet (2') wider than pavement except for dip type drives. Pavers are not allowed in the right-of-way but may be allowed beyond the right-of-way for driveway or parking purposes if approved by the City Engineer.
  - g. Right-turn deceleration lanes and associated additional right-of-way shall be provided when the peak hour right-turn movements exceed forty per hour. Deceleration lanes shall be at least one hundred feet long with a one hundred-foot transition.
  - h. Driveway Grades - The maximum driveway grade for the portion of driveway constructed in public right-of-way shall be ten percent (10%), measured from the edge of shoulder, for residential driveways on rural streets and six percent (6%) for commercial driveways. Driveways of both types onto a street or roadway with a higher classification than rural, shall have a maximum grade of three percent (3%) for the first thirty feet (30') off the edge of pavement of the public street roadway. Driveways in subdivisions shall blend to a common level without abrupt changes.
6. Common Driveways: The use of common driveways for adjacent property shall be encouraged. Joint driveway approaches may be approved provided a permanent access easement has been granted to each property owner to use the portion of driveway on the other lot and a letter of agreement signed by all adjoining property owners is delivered to the City Engineer or designee.
7. Sight Distance, On-site Maneuvering and Parking Lot Design. Adequate site distance and on-site maneuvering should be available from every driveway. Any movement for which adequate sight distance is not available or any parking lot design that does not provide adequate on-site maneuvering should not be permitted. For example, if parking is within twenty-five feet (25') of the driveway for commercial or multi-family developments under three acres or within fifty feet of the driveway for commercial or multi-family development over three acres (3 ac), either the parking should be rearranged or joint access should be considered or access to another street should be sought. Adequate driveway throat length shall be provided to reduce congestion. If sight distance problems are anticipated at the location of the proposed driveways, only one driveway will be permitted at a site to be determined by the design engineer that provides the safest access to the public right-of-way. Where alternate access is possible, access at hazardous locations is prohibited.
8. Drainage at Drive Approaches
- a. Conveyance - Driveway installations requiring conveyance for storm drainage in roadside ditches shall be sized to provide adequate area to pass the twenty-five-year frequency storm runoff.
  - b. Dip-Type Driveways - Properly designed and installed dip-type driveway installations function better to pass roadside drainage with minimum scour damage to driveway and/or road shoulders or surface and are preferred where terrain will allow economical installation. Standard details are provided in the Bastrop County Construction Standards for both concrete and asphalt surfaces. Installation of dip-type driveways approved under

these standards for subdivision development shall be the responsibility of the Developer. If the Developer does not wish to construct these driveways at the time the roadways and other improvements are constructed or prior to sale of lots, he must provide cash bond or performance bond in the amount of the driveway construction cost to the City prior, to approval of other subdivision improvements. Dip-type driveways may be allowed provided the design event flow can be accommodated. Dip-type driveways shall be constructed of six-inch concrete paving from the edge of pavement to the property line. Such driveways shall not exceed a slope of 0.5' over a distance of 10 feet.

- c. Culvert Pipe Driveway Installations - Installation of culvert pipe driveway entrances for subdivision development approved under these standards shall be the responsibility of the Developer. If the Developer does not wish to construct these driveways at the time the roadways and other improvements are constructed, he must provide a cash bond or performance bond to the City and/or County in the amount of the driveway construction cost prior to approval of other subdivision improvements.

- (1) Culvert Pipe Length - The length of culvert pipe, where used, be sufficient to allow for driveway base width (including radius as applicable) plus three times the pipe diameter plus three feet (3'), but in any case, no less than twenty feet (20').

9. Abandoned driveways: Whenever the use of any driveway approach is abandoned and not used for ingress and egress to the abutting property, it shall be the duty of the abutting property owner to restore the curb to the standards of the city.

#### N. Medians and Median Openings

1. Medians. Medians shall not be constructed in dedicated public right-of-way unless specifically required by and/or approved by the City Engineer. In most cases, medians approved for aesthetic purposes shall be maintained by, and at the expense of, the dedicator in accordance with specific contractual arrangements with the city. Medians required for traffic control shall be designed for minimum maintenance.
2. Medians may be required along rural arterials where street intersection spacing is less than one thousand three hundred feet (1,300'), or driveway spacing is less than two hundred feet (200'). Median breaks shall be located at intersections with arterials, collectors, industrial streets, and driveways to major traffic generators.
3. Median Openings. If medians are constructed on any arterial street, spacing between median openings should be at least four hundred feet (400'). The spacing may be reduced if a competent traffic study shows that a lesser spacing will still safely and efficiently accommodate left-turn movements to existing and projected future development in the immediate vicinity.

#### O. Traffic Control and Street Signs

1. Installation of Traffic Signs. The developer of a subdivision shall be required to install all traffic control sign or devices in accordance with Texas Department of Transportation's Manual for Uniform Traffic Control Devices and reviewed by the City and County prior to installation. The installation of such control signs or devices shall be the responsibility of the developer. The developer shall provide poles and any necessary traffic control signs (such as stop signs) as directed by the City Engineer.
2. Installation of Street Signs. The developer of a subdivision shall install the street name signs on new streets when they are constructed in accordance with the standards in this Ordinance. The proper installation of these signs is a part of the required construction standards of the City and will be inspected for approval prior to the release of the Construction Bond or other security. The developer shall provide all street identification signs and attachment hardware for streets within the subdivision. The street identification signs shall be constructed in accordance with the requirements in the design standards and criteria.

- a. **Street Signs:** Street signs are required at all intersections. Signs should be of a type that meets the current City sign standard or match the existing street signs of the adjacent joining streets. Street name sign assemblies shall be post-mounted with at least one assembly at each intersection of roadways.
- b. **Sign Faces.** Sign blanks shall be double faced to indicate street names on both sides. They shall be a minimum of nine inches (9") high and thirty-six inches (36") in length as needed to adequately space six-inch (6") series "C" lettering. They shall be 0.80-gauge aluminum blanks with Alodine® finish and covered with green reflective sheeting with silver (white) copy and optional three-eighths inch (3/8") silver (white) borders. Designations such as Street (St), Road (Rd), etc., shall be standard abbreviations as indicated in Table 10-6 below.
  - (1) **Standard Abbreviations.** Standard abbreviations listed shall be used. Periods, hyphens, commas, and question marks are not to be included on standard faces.

Table 10-6

Street Name	Abbreviation	Street Name	Abbreviation
ALLEY	ALLEY	PARKWAY	PKWY
AVENUE	AVE	PLACE	PL
BOULEVARD	BLVD	PLAZA	PLZ
CIRCLE	CIR	ROAD	RD
COURT	CT	SOUTH	S
DRIVE	DR	SOUTHEAST	SE
EAST	E	SOUTHWEST	SW
FREEWAY	FRWY	SQUARE	SQ
HIGHWAY	HWY	STREET	ST
HILL	HILL	TERRACE	TER
JUNCTION	JCT	THRUWAY	TWY
LANE	LN	TRAIL	TR
NORTH	N	WAY	WAY
NORTHEAST	NE	WEST	W
NORTHWEST	NW		

- c. **Sign Copy.** Sign copy, both letters and numbers, shall be six-inch (6") size series "C" stroke as conforms to the "Standard Alphabet for Highway Signs" Manual and in accordance with the accompanying drawings. Block numbers shall be placed in the upper right-hand corner of the sign face.
- d. **Mounting Hardware.** The hardware shall consist of two (2) standard cast aluminum street name sign brackets, one post cap (lower) bracket for the more important roadway name and one crosspiece (upper) bracket for the less important roadway name. Bracket hardware shall lock securely to post and to sign blanks with Allen-type screws. Sign

blanks shall be positioned when mounted to have their faces parallel to the roadway they name.

- e. Posts. Posts shall be two-inch (2") galvanized steel pipe of sixty-five thousandths (.065) minimum gauge securely set and tamped or cemented in place with top of post seven feet (7') above the edge of roadway surface.
- f. Placement. The street name sign assembly should be placed on a post and located two feet (2') behind the curb on curbed roadways or six to ten feet (6'-10') beyond the edge of the pavement on non-curbed roadways. It should be placed as near as possible to the tangent point of the edge of the less important roadway with the radius of the curve at the intersection.

P. Sidewalks and Bike Trails

1. Unless otherwise approved by the Planning and Zoning Commission, sidewalks shall be installed in all new subdivisions within the City and Statutory ETJ as follows:
  - a. On the subdivision side of all arterials and collector streets adjacent to the subdivision;
  - b. On both sides of all internal arterial, collector, and local streets of a subdivision;
  - c. Such additional sidewalks as the subdivider may desire;
  - d. Sidewalks shall be placed in the right-of-way and shall be a minimum of five feet (5') in width but must be at least six feet (6') in width if placed at the back of the curb; Sidewalks abutting business property shall be a minimum width of six (6) feet.
  - e. Sidewalks should be generally parallel to and not more than two (2) feet above or below adjacent curb grade and shall be located one (1) foot inside the dedicated right-of-way line and situated wholly within the dedicated right-of-way.
  - e. Wherever walks end, cross streets or parking areas, they shall bend to a common level by constructing handicapped ramps in compliance with ADA dimensions and regulations. Swept corner or other approved handicapped access curb ramps shall be provided at all intersections and crosswalks.
  - f. Sidewalks in Rural subdivisions (i.e. in ETJ) may substitute a pedestrian trail system that connects residential lots to nearby commercial areas and amenities in lieu of a traditional sidewalk. The pedestrian trail system may be constructed of alternate materials (e.g. crushed granite) and may use road margins (paved shoulders) if they are at least five feet (5') in width. Rural sidewalks and pedestrian trail systems shall be maintained by a property-owners association until such time as it is annexed into the City.
2. Construction: Sidewalks shall be constructed of concrete (or otherwise having an City-approved all-weather and dust free surface) in accordance with the city's Construction Standards Manual and in accordance with the city standard design details. Sidewalks shall have a minimum pavement thickness of four inches of reinforced concrete with a minimum compressive strength of three thousand pounds per square inch. All sidewalks shall be of a continuing common surface, not interrupted by steps or abrupt changes in level. Sidewalks shall have a minimum cross slope of 0.015 foot per foot for drainage. All sidewalks shall be broom-swept smooth and uniform to provide a non-slip surface. Construction details shall be in accordance with the City's standard specifications.
3. Parkways: Parkways shall be graded with a slope not less than 0.015 foot per foot. Except as otherwise provided by city ordinance or policy, no other structures or trees and shrubs shall be placed in the parkway. Landscaping plans for the parkways must be approved by the Bastrop parks and recreation board. The area between curb and sidewalk shall be excavated or filled to provide a uniform grade to match with the longitudinal street grade. The ground elevation at the right-of-way line shall be not more than two (2) feet nor less than three (3) inches above the elevation of the top of the adjacent curb.



4. Bike Trails: Any subdivision that contains or adjoins a route for a bike trail as shown in the current comprehensive plan shall provide sufficient right-of-way and construct the portion of the bike trail that lies within or adjacent to the subdivision. The bike trail pavement shall be at least ten feet in width made of concrete to AASHTO design standards. Right-of-way dedication for this purpose may be used as a credit toward parkland dedication requirements in Section 16.04.045.
5. Pedestrian Trails: Where permitted, pedestrian trails shall be of a width and surface acceptable to the City Engineer.
6. Time of Installation: Sidewalks shall be installed at the time of subdivision construction for all commercial, industrial, and multifamily subdivisions. In single-family residential subdivisions, sidewalks for each lot may be installed by the home builder at the time of home construction during the first four years after acceptance of the subdivision. At the time of final plat submittal, the developer shall submit a cash or performance bond (or other approved financial assurance instrument) to construct twenty percent of the required sidewalks. At the end of the four-year period, the developer shall construct the remaining sidewalks in the subdivision, or the city shall exercise the bond and construct them. The city shall refund any funds not required for sidewalk construction at the end of the four-year (4 yr) period.

Q. Parking Lots

1. Parking Lots. The required number of parking and loading spaces shall be provided in accordance with the city's zoning ordinance. Parking shall be designed to facilitate efficient traffic movement with a minimum conflict. All parking maneuvers shall be accomplished off public right-of-way. Off-street parking layouts shall afford the driver the ability to accomplish all maneuvers to enter or exit the parking spaces on private property. Adequate stack space shall be required for entrances into parking lots to prevent congestion backing onto the arterial.
2. Off-street parking areas shall be maintained by the owner.
3. Except for projects in the Form-Based Code zoning district, no new "head-in" parking is permitted, except for one- and two-family residential lots. Existing head-in parking may be required to be eliminated when the City Engineer determines that prevailing traffic conditions require the elimination of existing head-in parking that makes use of public rights-of-way to correct a serious traffic hazard.
4. Nothing in this section shall require the changing of existing driveways and/or parking except under one or more of the following conditions:
  - a. During widening and/or reconstruction of streets, the driveways will be brought into conformity with the present standards and head-in parking will be eliminated; or
  - b. During new building construction or major additions (i.e. increasing the building footprint by more than ten percent (10%), individually or cumulatively) of existing buildings all driveways and parking requirements will be brought into conformity with the present standards and head-in parking will be eliminated.
5. Parking lots should be designed with a minimum pavement thickness of five inches of five-sack concrete with a minimum compressive strength of three thousand pound per square inch reinforced with #3 bars on twenty-four-inch centers in both directions over fill sand, lime or cement-stabilized subgrade or equivalent. Alternative porous pavements (such as concrete pavers, grass pavers, or gravel pavers or otherwise having an City-approved all-weather and dust free surface) may be considered on a case-by-case basis.

R. Fire Lanes

1. Fire Lanes. Fire lanes shall be constructed in accordance with the requirements for fire apparatus access roads in the International Fire Code as adopted by the city of Bastrop, unless otherwise specified herein. The location requirements for fire lanes shall be

established by the City's Fire Marshall. No certificate of occupancy shall be issued until the required fire lanes are constructed, inspected and approved.

2. Fire lanes shall have a minimum width of twenty feet and shall have a minimum vertical clearance of fourteen feet. The minimum inside turning radius shall be twenty-five feet and the minimum outside turning radius shall be forty-five feet. All dead-end fire lanes exceeding one hundred feet in length shall have a turn-around with minimum radius of fifty feet. Fire lanes shall not have a grade exceeding ten percent. Fire lanes shall be clearly marked as a fire lane and parking prohibited. Markings must be maintained at all times.
3. Fire lanes shall be constructed of an all-weather pavement designed and maintained to support the imposed load of fire apparatus weighing at least seventy-five thousand pounds (75,000 lbs). Unless otherwise approved by the City Engineer, such pavement shall consist of five-inch (5") thick concrete pavement in light traffic areas and six-inch (6") thick concrete pavement in areas expected to receive heavy truck traffic, such as service drives. In both cases, pavement shall have a minimum of five and one-half (5-1/2) sack concrete with a minimum compressive strength of three thousand six hundred pounds per inch (3,600 psi) reinforced with #3 bars on twenty-four-inch (24") centers in both directions. In both cases, concrete shall be poured over stabilized subgrade. The developer or contractor shall submit a pavement design for the fire lanes prior to construction and the construction must be inspected. The contractor shall provide test results verifying the strength of the concrete, at the direction of the City Engineer.

S. Street tree requirements.

All development shall be required to plant street trees in accordance with the following standards and in accordance to the Construction Standards Manual. The Director of Planning may approve alternative street tree plans due to special site conditions, which may, for reasons such as safety, site conditions, or existing trees on the lot, affect the ability to meet these regulations.

1. Street Tree Plan. All development shall be required to submit a master street tree plan noting location, number, and species of trees to be used within the development.
2. Location. Street trees shall be located between the sidewalk and the right-of-way line, except in cases where there is a designated planting strip in the right-of-way, or the sidewalk is greater than eight feet wide and designed to accept trees in tree wells. Trees will normally be planted eight feet behind the curb.
3. Number and Spacing. Street trees shall be planted by the following requirements:
  - a. Spacing Along Street.
    - (1) Single-Family Residential. Spacing of street trees within single-family residential developments shall be conducted as follows:
      - (a) One tree per lot, evenly spaced;
      - (b) Corner lots for all single-family developments shall require two or more street trees, evenly spaced, depending on the length of frontage on each street for such lots.
    - (2) Multi-Family Residential, Townhome and Nonresidential Developments. Spacing of street trees within multi-family residential, townhome or nonresidential developments shall be one tree for every one hundred linear feet (100 LF) of street frontage.
    - (3) Intersections. Street trees on corner lots for all developments shall be located a minimum of twenty-five feet (25') from the property corner adjacent to the street right-of-way intersection, and otherwise outside of the public Open Space Easement required by Section 10.36.020.D.

b. Spacing from Utilities.

- (1) Water and Wastewater Service Lines. No trees shall be planted closer than nine feet (9') from any underground water or wastewater utility connection. The location of the water and wastewater utility line shall be considered, for distance purposes, to be the surface of the ground above the line.
- (2) Fire Hydrants. No trees shall be planted closer than ten feet (10') from any fire hydrant.
- (3) Street Lighting. Street trees should be installed, and spacing may be adjusted, to avoid street lights that are installed in accordance with Section 10.36.080 of this ordinance. The city planner may waive the requirement to plant a tree that conflicts with a street light if it is demonstrated that no reasonable alternative exists.
- (4) Root Barrier System. Spacing requirements from utilities may be reduced at the discretion of the City Engineer with a street tree plan submitted and approved which would include the installation of root barrier systems approved by the City Engineer.

4. Tree Species.

- a. Street Tree Species Type. Tree species to be used for street trees shall be one of the following species:

Bald Cypress (*Taxodium distichum*);  
Bur Oak (*Quercus macrocarpa*);  
Carolina Buckthorn (*Frangula caroliniana*);  
Cedar Elm (*Ulmus crassifolia*);  
Chinquapin Oak (*Quercus muehlenbergii*);  
Desert Willow (*Chilopsis linearis*);  
Eve's Necklace (*Sophora affinis*);  
Live Oak (*Quercus virginiana*);  
Mexican Buckeye (*Ungnadia speciosa*);  
Post Oak (*Quercus stellata*);  
Redbud (*Cercis Canadensis*);  
Red Oak (*Quercus shumardii*);  
Shumard Oak (*Quercus shumardi*).

Alternate species may be used only upon approval by the city's Director of Planning.

- b. Species Diversity. Street tree species shall be of the same variety along an individual block. The same species of tree shall not be used on streets which are generally parallel and within two blocks apart. If a species of tree is approved to be installed on the dead-end street, the same species of tree should be used on the extension of the street into the new subdivision.

5. Maintenance.

- a. Street trees shall be maintained by the adjoining property owner. It is the adjoining property owner's responsibility to thin, prune, spray, water and fertilize, and otherwise maintain street trees, as may be deemed necessary and feasible. All incurred costs are to be borne by the property owner.

- b. Tree Canopy Height. The street tree shall be maintained by pruning, thinning and other necessary care by the adjacent property owner to ensure a minimum clearance of fifteen vertical feet from the curb line to any intruding canopy branches.
- c. Removal of Trees or Plantings in Public Right-of-Way. The city may remove any planting which constitutes a hazard or may endanger the health, well-being or property of the public or which constitutes an obstruction to the vision of traffic.
- d. Tree Replacement. The city may replace an approved street tree or other planting which has died or may have been removed for any reason (including utility work), or plant additional street trees deemed appropriate and consistent with available resources.
- e. Abuse or Mutilation. It shall be unlawful for any person to break, destroy, or mutilate any approved street tree, or to set fire or permit any fire to cause damage to any portion of any street tree, or to attach or place any rope or wire, sign, poster or other device on any street tree.

#### 10.36.040 - Blocks and lots.

##### A. Blocks.

1. The length of a block shall be the distance from property corner to property corner measured along the property line of the block face of greatest dimension, or on which the greatest number of lots face. The width of a block shall be the distance from property corner to property corner measured along the property line of the block face of least dimension, or on which the fewest number of lots face. The block perimeter shall be considered the sum of all block lengths and widths to encircle the block. The length, width and shapes of blocks shall be determined with due regard to provision of adequate building sites suitable to the special needs of the type of use contemplates, zoning requirements as to lot sizes and dimensions, and needs for convenient access, circulation, control and safety of street traffic.
2. Block perimeters shall not exceed one thousand, six hundred linear feet (1,600'), unless broken by a Civic Space Lot that is fifty feet (50') wide and provides perpetual pedestrian access between the blocks and to any lots that from the Civic Space Lot and allow utilities, drainage, or other accommodations in the best interest of the immediate and adjacent properties. Smaller blocks are encouraged to promote walkability. Even with Civic Space Lots, block lengths shall not exceed one thousand six hundred feet.

Block perimeters may exceed this limit, up to a maximum of two thousand linear feet (2,000'), only if one or more of the following conditions apply:

- 1) The block is assigned to the Form-based Code zone,
  - 2) The block has at least one block face on an arterial street, or
  - 3) The block contains valuable natural features or significant historic resources that should not be crossed by a street,
3. Any single block face wider than five hundred feet (500') must include a publicly-dedicated sidewalk, passage, or trail at least eight feet (8') feet in width that connects to another street.
  4. Block Numbering: Blocks shall be lettered consecutively within the subdivision and/or sections of an overall plat as recorded.
  5. Rural Subdivision Block Requirements
    - a. Rural Block Lengths. Residential blocks in subdivisions shall not exceed two thousand feet (2,000') in length. Commercial and industrial block lengths may be up to two thousand feet (2,000') in length, provided that the requirements of traffic circulation and utility service are met. Block lengths may be varied according to the requirements of circulation, utility service, and topography.

- b. Rural Block Widths. Block widths in residential subdivisions shall be such as to allow for two (2) tiers of lots back to back, except where abutting a thoroughfare to which access to the lots, is prohibited, or where prevented by topographical conditions or size of the property.

B. Lots.

1. The lot arrangement and design shall be such that all lots will provide satisfactory and desirable building sites, properly related to topography and the character of surrounding development.
2. All side lines of lots shall be at approximately right angles to straight street lines and radial to curved street lines except where a variation to this rule will provide a better street and lot layout. Rear lot lines should be straight and avoid acute angles with side yard lines. Odd-shaped lots should be avoided. Where utility easements are to be located along rear lot lines, these lines should be as straight as possible for long lengths.
3. Access to Lots
  - a. Each lot in a subdivision shall abut on a public street, or an approved public access easement or private street.
4. Lot Size: Lots shall be consistent with zoning regulations. For lots located in the extraterritorial jurisdiction, the minimum lot size shall be one acre (1 ac) unless a cluster subdivision has been approved under Section 10.36.005.B above. When the specific proposed use of a lot or tract depends upon future action by the city council or other properly designated authority, lot lines shall also be shown on the preliminary plat appropriate to a use that does not require such action. Proposed uses shall be shown on the preliminary plat.
  - a. Lot Size. Rural Subdivision shall be designed to provide an average lot size of two (2) acres excluding streets and public lots or tracts with a minimum area of one (1) acre per each lot located outside the boundary of flood plain or drainage easements. In no case can more than fifteen (15) percent of the total number of lots in the rural subdivision be less than one and one-half (1.5) acres each.
  - b. If a lot is required to be served by an on-site wastewater facility and where soil evaluation test prescribed by the Texas Commission on Environmental Quality (TCEQ) deems the minimum lot area insufficient, the City shall require additional area sufficient to accommodate the on-site facilities in accordance with TCEQ criteria.
5. Lot Width: No lot shall have less width at the building line than is required by the zoning regulations that apply to the area in which it is located. Flag lots shall be prohibited. Lots which front along a cul-de-sac arc or arc of a street curve shall have a minimum lot width of thirty-three (33) feet as measured along the chord of the arc at the property line.
6. Commercial Lot frontage along proposed arterial roads and existing State highways, and county roads shall be not less than three hundred feet (300') unless access is restricted to interior or abutting streets, joint use driveway agreement, or access easements. The City may approve lot frontage less than three hundred feet (300') provided a joint use driveway agreement or access easement restricts the number of driveways to fewer than one (1) per three hundred feet (300') of frontage.
7. In general, lots should be deeper than they are wide. It is recommended to have the depth twice the width. The important consideration is to assure that the lots are neither too deep nor too shallow to allow for good placement of a dwelling on a lot.
8. Lots facing onto heavy traffic streets shall be avoided. This can be accomplished by providing deeper lots with the houses backing onto the heavy traffic street. Other methods include:
  - a. Providing an access street parallel to the major street;
  - b. Cul-de-sac if the property has sufficient depth; or

- c. Provide a loop street, if the property has sufficient depth and width.
9. Lot Orientation:
- a. Street Frontage: Each lot shall be provided with the minimum frontage on an existing or proposed public street.
  - b. Double Front: Double front lots are prohibited except when backing on major thoroughfares. Access to major thoroughfares shall be prohibited.
  - c. Front Facing: Whenever feasible, each lot should face the front of a similar lot across the street. In general, an arrangement placing adjacent lots at right angles to each other should be avoided.
10. Building Lines: Front and second front (exterior side) building lines shall be shown on all lots in the subdivision. The building lines shall be listed in accordance with the minimum applicable to the zoning district. Building lines on plats may exceed the minimum required by the zoning ordinance.

If not otherwise specified (including rural lots), the indicated minimum setbacks shall be observed for the following features:

- a. State Highways - 50 feet
  - b. County and other roads:
    - Rural Section - 40 feet
    - Urban Section - 25 feet
  - c. Alleys - 20 feet
  - d. Adjacent side property lines - 10 feet
  - e. Adjacent rear property lines - 25 feet
  - f. Adjacent buildings not subject to other setbacks - 15 feet (unless a fire rated wall is provided - see fire district)
  - g. Drainage ditches and channels - shall be treated the same as front, side or rear setbacks (as measured from the nearest point of the easement or 100-year water spread, whichever is greater)
  - h. Railroad right-of-way - 50 feet from a through running section (as measured from the nearest point of the right of way).
  - i. Railroad right-of-way - 25 feet from a spur or siding section (as measured from the nearest point of the right of way). Note: Trans-shipment facilities are exempt from this setback.
  - j. Gas or petroleum pipelines - 100 feet (as measured from the nearest point of the easement)
  - k. High voltage transmission lines or transmission towers - 50 feet (as measured from the nearest point of the easement).
11. Lot Numbering: All lots shall be numbered consecutively within each block. Lot numbering may be cumulative throughout the subdivision if the numbering continues from block to block in a uniform manner if approved for the preliminary plat
12. Orientation to Creeks and Streams. Any lots that are contiguous to the major stream channels (Colorado River, Piney Creek, Gills Branch, or any other perennial stream) shall be oriented so that their front shall face the creek across a public street. No more than fifty percent (50%) of the lots abutting a stream, parkland, or FEMA floodplain shall be oriented so that the rear of the lot abuts the stream corridor.

13. Orientation to Public Parks. No more than fifty percent (50%) of the boundary of a public park may be contiguous to the rear lot line of residential lots. All other residential lots must face the public park across a public street.
14. Surface drainage must be diverted away from house sites to a public right-of-way or dedicated drainage easement. Sufficient slope must exist on the lot to enable drainage to runoff from the building site across sidewalks, and onto the street. Swales may be needed to provide drainage from backyards.

#### 10.32.050 - Boundary Monuments and Property Markers

- A. Boundary Marker: Concrete monuments shall be placed along the boundary of the subdivision at intervals not exceeding thirteen hundred feet (1300'). Such monuments, shall be a minimum of eight inches (8") in diameter and eighteen inches (18") deep, except where rock is encountered within fourteen inches (14") of the surface in which case such monuments shall be countersunk in such rock to achieve a firm interlock. The exact point shall be clearly marked by a suitable means. Survey monuments shall be noted on the final plat with bearing and distance ties between the monument and to adjacent property corner or street right-of-way point. The subdivider shall, at their expense, cause the monument to be placed and approved in the designated location prior to final acceptance of the subdivision by the County.
- B. Intermediate property corners, curve points and angle points shall be marked by iron stakes, not less than eighteen inches (18") in length and one-half (½) inch in diameter, driven flush with the ground or countersunk if necessary to avoid being disturbed.

#### 10.36.060 Drainage

##### A. General.

1. Conformance with Comprehensive Plan. All drainage design must comply with the City of Bastrop Comprehensive Master Plan and the effective Flood Insurance Study (FIS) and effective Flood Insurance Rate Maps (FIRM) prepared by the Federal Emergency Management Agency. The developer shall provide those drainage improvements which traverse or abut the proposed subdivision, where specified in the comprehensive plan. All cost for such improvements shall be paid by the developer, except where the city manager shall determine that the improvements benefit other citizens more than that of the proposed subdivision and shall determine the equitable city participation in such improvements. Such city participation, or any appeal of such requirements, shall be approved by the city council.
2. To protect health, safety and environmental quality, it shall be the policy of the city of Bastrop that no new development will be allowed within the one hundred-year floodplain, as delineated by the Federal Emergency Management Agency. Undeveloped land within the floodplain may be used for agricultural purposes, be incorporated into adjacent lots outside of the floodplain, or set aside as private or public open space.
3. Development shall not increase the peak flow discharge or velocities over natural conditions, particularly on adjacent and downstream properties for the one-year, twenty-five-year or one hundred-year, twenty-four-hour storm events, unless a downstream assessment shows no impact to the downstream receiving stream. When preliminary drainage studies indicate that peak flows or velocities will be increased, then detention basins or other techniques shall be provided to reduce flows to natural conditions.
4. The owner or developer of property to be developed shall be responsible for the conveyance of all storm drainage flowing through or abutting subject property. This responsibility includes the drainage directed to that property by prior development, future development of the watershed, as well as the drainage naturally flowing through the property.
5. The subdivider shall pay for the cost of all drainage improvements required for the development of the subdivision, including any necessary off-site channels or storm sewers and acquisition of the required easements.

6. The Planning and Zoning Commission shall not recommend for approval any plat of a subdivision which does not make adequate provisions for storm or floodwater runoff channels or basins. Drainage provision shall ensure the health and safety of the public and the property in times of flood.
7. Where the improvement or construction of a storm drainage facility is required along a property line common to two (2) or more owners, the owner hereafter proposing development or use of their property, shall be responsible for all the required improvements on either side of the common property line, regardless of ownership, at the time of development, including the dedication by the legal owner(s) of all necessary rights-of-way or easements, to accommodate the construction and maintenance of improvements.
8. Where a property owner proposes development or use of only a portion of their property, provision for storm drainage shall only be required in that portion of the property proposed for immediate development or use, except as construction or improvements of a drainage facility outside that designated portion. However, future development runoff should be considered in the design of the proposed development.
9. The owner or owners shall dedicate to the City the required drainage easements and/or rights-of-way to contain the drainage improvements or surface water flows. Determination of minimum easements and/or rights-of-way required shall be made by the City Engineer.
10. The responsibility of the owner or developer shall extend to provision of adequate drainage improvements to accommodate the full effects of the development of their property. Such drainage improvements shall prevent a diversion, impounding or increase of the natural flow of surface waters caused by the development of the property from damaging the property of another. The term "natural flow" as used herein is meant to describe the conditions existing downstream of the property prior to and after the proposed development. Such improvements may be on-site or off-site, or a combination of both, and shall be made at the expense of the owner or developer. Such drainage improvements shall be a condition of plat approval.
11. Inundation by a One-Percent Probability (100-Year Frequency) Storm: Any water course, whether natural or manmade, shall have provision to accommodate the rainfall runoff generated by a 100-year frequency storm such that there is no loss of, or be detrimental to, property or to create an undue inconvenience to the public.
  - a. Any watercourse with a contributing drainage area greater than ten (10) acres, whether natural or manmade, shall have provision to accommodate the rainfall runoff generated by a one hundred (100) year frequency storm such that there is no loss of, or be detrimental to, property or to create an undue inconvenience to the public.
  - b. Delineation of the limits of areas subject to inundation by a one hundred (100) year frequency storm shall be shown on a drainage plan and shall be based on detailed hydrologic and hydraulic computations prepared by a Registered Professional Engineer of the State of Texas. Effective FEMA floodplain information shall be shown when available.
  - c. Easements shall be provided to contain areas inundated by a one hundred (100) year frequency storm along natural and manmade drainage ways and any additional width necessary to provide sufficient ingress and egress for maintenance purposes.
  - d. A grading plan shall be prepared for each subdivision, by a Registered Professional Engineer of the State of Texas, and show in sufficient detail grading of all roads, streets, drainage structures, channels, swales, or other drainage related features and provide minimum finished floor elevations, based on an acceptable elevation datum, for proposed structures to assure no inundation of such structures by the rainfall run-off by a 100-year frequency storm. All buildings shall have a minimum finished floor elevation of two feet (2') above the base flood elevation water surface elevation generated by a 100-year frequency storm, or as stipulated in the City of Bastrop's Flood Damage Prevention Regulations, whichever is greater.



B. Design Process and Criteria

1. Drainage shall be designed for three goals (water quality, streambank protection, and flood mitigation), to be evaluated by four storm events for projects with more than one acre of land disturbance, as shown in Table 10-7.
  - a. Water Quality Protection and Pollution Prevention: Runoff from impervious areas can pick up pollutants from the pavement and rooftops. Drainage should be designed to reduce and remove pollutants in stormwater runoff to protect water quality downstream. This generally involves using an acceptable level of low-impact development techniques or by providing sedimentation and/or other treatment to the first 1.5 inches of rainfall to remove suspended solids.

<b>Storm Event Name</b>	<b>Storm Event Description</b>
"Water Quality"	Criteria based on a volume of 1.5 inches of rainfall, not a storm frequency
"Streambank Protection"	2-year, 24-hour storm event
"Conveyance"	25-year, 24-hour storm event
"Flood Mitigation"	100-year, 24-hour storm event

- b. Streambank Protection: Increased peak flows from urban runoff can increase erosion from more frequent bank full flows. Streambank protection can be provided by minimizing increases the 2-year, 24-hour storm event by reducing the controlled release of water of the 2-year, 24-hour storm over 24 hours from the site. Reinforcing or stabilizing streambanks downstream may also be used in limited circumstances. A downstream assessment will be required.
    - c. Flood Mitigation and Conveyance: To protect citizens and property from flooding, increases in the 100-year, 24-hour storm event must be controlled. Flood mitigation can be met by limiting discharges from the site to no more than under pre-development conditions, or by providing adequate conveyance of the 100-year flows downstream of the site. A downstream assessment will be required. Protection during the Conveyance storm event (25-year, 24-hour storm) is designed to minimize localized flooding of streets, sidewalks and property.
2. Design process:
  - a. Site Analysis: Using field and mapping techniques approved by the City Engineer, the developer's engineer shall collect and review information on the existing site conditions and map the following features:
    - (1) Topography
    - (2) Drainage patterns and basins
    - (3) Intermittent and perennial streams on-site and off-site that contribute or receive water from the site
    - (4) Soil types and their susceptibility to erosion
    - (5) Property lines, adjacent areas and easements
    - (6) Wetlands and critical habitat areas

- (7) Boundaries of wooded areas and tree clusters (tree survey)
- (8) Existing FEMA Floodplain boundaries
- (9) Ground cover and vegetation, particularly unique or sensitive vegetation areas to be protected during development
- (10) Existing development
- (11) Existing stormwater facilities on-site and off-site that will receive discharges from the proposed development
- (12) Steep slopes
- (13) Required buffers and setbacks along waterbodies
- (14) Proposed stream crossing locations

b. Conceptual Drainage Plans

Based on the Site Analysis, the design engineer should prepare a Conceptual Drainage Plan for the proposed site layout to give the developer and the City Planning and Engineering staff an initial look at the project. This plan will typically be submitted along with the Sketch Plat. The Design engineer should typically follow the following steps:

- (1) Use applicable low-impact development techniques to develop the site layout, including:
  - (a) Preserving the natural feature conservation areas defined in the site analysis,
  - (b) Fitting the development to the terrain and minimizing land disturbance,
  - (c) Reducing impervious surface areas, and
  - (d) Preserving and using the natural drainage system wherever possible.
- (2) Calculate conceptual estimates for the design requirements for the water quality volume (1.5 inches of rainfall), 2-year 24-hour storm volume, and 100-year, 24-hour storm volume events.
- (3) Determine any appropriate temporary and permanent structural stormwater controls and identify potential locations on the site.

c. Preliminary Drainage Plans

This step builds on the data developed in the Conceptual Drainage Plan by ensuring that requirements and criteria are met, opportunities have been taken to minimize adverse effects of the development and providing more detail. The preliminary Drainage Plan will be submitted along with the Preliminary Plat and shall consist of maps, plan sheets, narrative and supporting design calculations (hydrologic and hydraulic) for the proposed stormwater system.

d. Final Drainage Plans

The final Drainage Plan and Construction Plans shall be submitted to the City Engineer along with the Final Plat or site Development plan prior to any construction activities.

e. Operations and Maintenance Plan

An Operations and Maintenance Plan shall be submitted along with the Final Drainage Plans to clearly state which entity has responsibility for the operation and maintenance of temporary and permanent stormwater controls and drainage facilities to ensure that they will function in the future. The O&M plan shall include, but not be limited to:

- (1) Responsible party for all facilities and tasks in the plan
- (2) Inspection and maintenance requirements

- (3) Maintenance of permanent stormwater controls and drainage facilities during construction
- (4) Cleaning and repair of permanent stormwater controls and drainage facilities before transfer of ownership
- (5) Frequency of inspections for the life of the permanent facility
- (6) Funding source for long-term maintenance
- (7) Description of maintenance tasks and frequency
- (8) Access and safety issues
- (9) Maintenance easements
- (10) Any required maintenance agreements, reviewed and approved by the City
- (11) Testing and disposal of sediments
- (12) Projected lifespan of structures and required replacement intervals

6. Design Criteria

- a. Hydrologic Methods: For general guidance on drainage calculation, the design engineer should use the integrated Storm Water Manual, Hydrology Technical manual ([http://iswm.nctcog.org/technical\\_manual.asp](http://iswm.nctcog.org/technical_manual.asp)). The design engineer may use any of the empirical hydrologic methods shown in Table 10-8, subject to the limitations indicated.
- b. Hydrologic design procedures shall conform to the following methods where appropriate and shall assume a fully developed watershed upstream of the proposed development. It may be assumed that the undeveloped area will be developed under the same regulations.
  - (1) T.R. 55, as prepared by SCS, may be used for drainage areas not exceeding two thousand (2,000) acres and with the criteria defined therein.
  - (2) For drainage areas exceeding two thousand (2,000) acres, either of the following methods is acceptable:
    - (a) "Computer Program for Project Formulation-Hydrology" distributed by SCS through Technical Release No. 20 (SCS-TR-20).
    - (b) Hydraulic Engineering Center, U.S. Army Corp of Engineers' Flood Plain Hydrologic Program (HEC1).
- c. Rainfall Estimation  
Rainfall estimates should use acceptable TxDOT or USGS values. Rainfall intensity shall be computed using the following Intensity-Duration-Frequency (IDF) equation and coefficients.

$$i = b / (t + d)^e$$

where:

$i$  = rainfall intensity (inches per hour)

$t$  = rainfall duration (minutes) or time of concentration

$b$ ,  $d$  and  $e$  = parameters found in Table 10-9 below

Rainfall intensities for Bastrop Depth-Duration-Frequency (DDF) values are provided in Table 10-10 below.

Time of concentration can be calculated by the nomograph or the equation in the iSWM Technical Manual but must remain within the ranges in Table 10-11.

- c. Rational Method: For drainage areas less than 100 acres, the Rational Method is acceptable. To determine the runoff rates for the various areas, the standard rational method may be used. The Rational Formula is expressed as follows:

$$Q = CIA$$

where:

Q = maximum rate of runoff (cfs)

C = runoff coefficient representing a ratio of runoff to rainfall

I = average rainfall intensity for a duration equal to the  $t_c$  (in/hr)

A = drainage area contributing to the design location (acres)

Method	Size Limitations <sup>1</sup>	Comments
Rational	0 – 100 acres	Method can be used for estimating peak flows and the design of small site or subdivision storm sewer systems.
Modified Rational <sup>2</sup>	0 – 200 acres	Method can be used for estimating runoff volumes for storage design.
Unit Hydrograph (SCS) <sup>3</sup>	Any Size	Method can be used for estimating peak flows and hydrographs for all design applications.
Unit Hydrograph (Snyder's) <sup>4</sup>	1 acre and larger	Method can be used for estimating peak flows and hydrographs for all design applications.
TXDOT Regression Equations	10 to 100 mi <sup>2</sup>	Method can be used for estimating peak flows for rural design applications.
USGS Regression Equations	3 – 40 mi <sup>2</sup>	Method can be used for estimating peak flows for urban design applications.
iSWM Water Quality Protection Volume Calculation	Limits set for each Structural Control	Method can be used for calculating the Water Quality Protection Volume (WQ <sub>v</sub> ).

<sup>1</sup> Size limitation refers to the drainage basin for the stormwater management facility (e.g., culvert, inlet).  
<sup>2</sup> Where the Modified Rational Method is used for conceptualizing, the engineer is cautioned that the method could underestimate the storage volume.  
<sup>3</sup> This refers to SCS routing methodology included in many readily available programs (such as HEC-HMS or HEC-1) that utilize this methodology.  
<sup>4</sup> This refers to the Snyder's methodology included in many readily available programs (such as HEC-HMS or HEC-1) that utilize this methodology.

Table 10-9. IDF Coefficients for Bastrop

	2 year	5 year	10 year	25 year	50 year	100 year
e	0.841	0.814	0.805	0.793	0.786	0.784
b	67	77	87	100	113	130
d	13.3	11.5	11.1	10.8	10.8	11.3

Source: TxDOT, 2015. New Rainfall Coefficients, Research Report 0-6824

Table 10-10. Rainfall Depth (in inches) for Bastrop by Duration and Recurrence Frequency

Tc(min)	2-year	5-year	10-year	25-year	50-year	100-year
15	1.0	1.33	1.57	1.89	2.19	2.5
30	1.4	1.85	2.18	2.63	3.05	3.57
60	1.8	2.37	2.8	3.4	3.97	4.58
120	2.17	2.89	3.42	4.18	4.89	5.68
180	2.39	3.2	3.79	4.64	5.45	6.34
360	2.75	3.73	4.45	5.49	6.45	7.52
720	3.13	4.31	5.17	6.42	7.55	8.84
1440	3.54	4.94	5.96	7.46	8.8	10.33

Design storm depth for given Annual Recurrence Interval in inches. 60 min. = 1 hr.; 120 min. = 2 hrs.; 180 min. = 3 hrs.; 360 min. = 6 hrs.; 720 min. = 12 hrs.; 1440 min. = 24 hrs. ]

Table 10-11 Time of Concentration Ranges

Land Use	Minimum (minutes)	Maximum (minutes)
Residential Development	10	30
Commercial and Industrial	10	25
Central Business District	10	15

Runoff coefficients in Table 10-12 must be used, unless otherwise authorized by the City Engineer.

The coefficients given in Table 10-12 above are applicable for storms with return periods less than or equal to 10 years. Less frequent, higher intensity storms may require modification of the coefficient because infiltration and other losses have a proportionally smaller effect on runoff (Wright-McLaughlin Engineers, 1969). The adjustment of the Rational Method for use with major storms can be made by multiplying the right side of the Rational Formula by a frequency factor  $C_f$ . The modified Rational Formula now becomes:

$$Q = C_f CIA$$

The  $C_f$  values that can be used are listed in Table 10-13. The product of  $C_f$  times  $C$  shall not exceed 1.0.

<b>Table 10-12 Recommended Runoff Coefficient Values</b>	
Description of Area	Runoff Coefficients (C)
Lawns:	
Sandy soil, flat, 2%	0.10
Sandy soil, average, 2 - 7%	0.15
Sandy soil, steep, > 7%	0.20
Clay soil, flat, 2%	0.17
Clay soil, average, 2 - 7%	0.22
Clay soil, steep, > 7%	0.35
Agricultural	0.30
Forest	0.15
Streams, Lakes, Water Surfaces	1.00
Business:	
Downtown areas	0.95
Neighborhood areas	0.70
Residential:	
Single Family (1/8 acre lots)	0.65
Single Family (1/4 acre lots)	0.60
Single Family (1/2 acre lots)	0.55
Single Family (1+ acre lots)	0.45
Multi-Family Units, (Light)	0.65
Multi-Family, (Heavy)	0.85
Commercial/Industrial:	
Light areas	0.70
Heavy areas	0.80
Parks, cemeteries	0.25
Playgrounds	0.35
Railroad yard areas	0.40
Streets:	
Asphalt and Concrete	0.95
Brick	0.85
Drives, walks, and roofs	0.95
Gravel areas	0.50
Graded or no plant cover:	
Sandy soil, flat, 0 - 5%	0.30
Sandy soil, flat, 5 - 10%	0.40
Clayey soil, flat, 0 - 5%	0.50
Clayey soil, average, 5 - 10%	0.60

Recurrence Interval (years)	C <sub>f</sub>
10 or less	1.0
25	1.1
50	1.2
100	1.25

e. Unit Hydrograph Methods:

The U.S. Soil Conservation Service (now called National Resources Conservation Service) unit hydrograph methods are acceptable for any size drainage area and are required for drainage areas larger than 100 acres. The engineer can propose to use other hydrologic methods but must have their use approved by the City Engineer. Details of the methodology can be found in the *SCS National Engineering Handbook, Section 4, Hydrology* or in the iSWM Technical Manual.

Detention ponds shall be designed using SCS unit hydrograph methods. The engineer can propose to use other hydrologic methods but must have their use approved by the City Engineer.

When unit hydrograph methods for computing runoff are proposed, a 24-hour SCS Type III storm shall be modeled as the rainfall event, with the following rainfall depths:

	2-year	5-year	10-year	25-year	50-year	100-year	500-year
24-hour depth (in)	3.6	5.1	6.2	7.7	9.0	10.2	13.5

The appropriate hydrologic soil group must be obtained from the SCS Soil Survey for Bastrop County for the soils that comprise the watershed. Curve Numbers can then be obtained from Table 10-14.

When a drainage area has more than one land use, a composite curve number can be calculated and used in the analysis. It should be noted that when composite curve numbers are used, the analysis does not account for the location of the specific land uses but sees the drainage area as a uniform land use represented by the composite curve number.

7. Runoff Treatment Approaches

a. Water Quality Volume Treatment

Treatment of the Water Quality Volume (first 1.5 inches of rainfall) can be accomplished by any of the following techniques:

- Bioretention
- Enhanced swales
- Alum treatment
- Detention
- Filters (sand or organic)

**Table 10-14 Runoff Curve Numbers<sup>1</sup>**

Cover Description		Curve numbers for hydrologic soil groups			
<i>Cover type and hydrologic condition</i>	<i>Average percent impervious area<sup>2</sup></i>	<b>A</b>	<b>B</b>	<b>C</b>	<b>D</b>
<b>Cultivated Land:</b>					
Without conservation treatment		72	81	88	91
With conservation treatment		62	71	78	81
<b>Pasture or range land:</b>					
Poor condition		68	79	86	89
Good condition		39	61	74	80
<b>Meadow:</b>					
Good condition		30	58	71	78
<b>Wood or forest land:</b>					
Thin stand, poor cover		45	66	77	83
Good cover		25	55	70	77
<b>Open space (lawns, parks, golf courses, cemeteries, etc.)<sup>3</sup></b>					
Poor condition (grass cover < 50%)		68	79	86	89
Fair condition (grass cover 50% to 75%)		49	69	79	84
Good condition (grass cover > 75%)		39	61	74	80
<b>Impervious areas:</b>					
Paved; curbs and storm drains (excluding right-of-way)		98	98	98	98
Paved; open swales (including right-of-way)		83	89	92	93
Gravel (including right-of-way)		76	85	89	91
Dirt (including right-of-way)		72	82	87	89
<b>Urban districts:</b>					
Commercial and business	85%	89	92	94	95
Industrial	72%	81	88	91	93
<b>Residential districts by average lot size:</b>					
1/8 acre or less (town house)	65%	77	85	90	92
1/4 acre	38%	61	75	83	87
1/3 acre	30%	57	72	81	86
1/2 acre	25%	54	70	80	85
1 acre	20%	51	68	79	84
2 acres	12%	46	65	77	82
<b>Developing urban areas and newly graded areas (previous areas only, no vegetation)</b>					
		77	86	91	94

<sup>1</sup> Average runoff condition, and  $I_a = 0.2S$

<sup>2</sup> The average percent impervious area shown was used to develop the composite CNs. Other assumptions are as follows: impervious areas are directly connected to the drainage system, impervious areas have a CN of 98, and pervious areas are considered equivalent to open space in good hydrologic condition. If the impervious area is not connected, the SCS method has an adjustment to reduce the effect.

<sup>3</sup> CNs shown are equivalent to those of pasture. Composite CNs may be computed for other combinations of open space cover type.

- Infiltration
- Ponds
- Green roofs



## Wetlands

The developer shall demonstrate that they have incorporated at least one of these approaches, or equivalent, or demonstrate to the City Engineer why their use is not feasible for their project.

### b. Downstream Assessments

In evaluating controls for streambank protection and flood mitigation, the downstream effects of the development must be evaluated. The assessment should extend from the outfall of the proposed development to a point downstream where the discharge no longer has a significant impact on the receiving stream or storm drain system, known as the zone of influence. Generally, the zone of influence is the stream length between the outfall and a point where the drainage area controlled by the detention or storage facility comprises ten percent (10%) of the total drainage area. The downstream assessment should include:

Hydrologic analysis of the pre- and post-development on-site conditions

Drainage path which defines the extent of the analysis

Capacity analysis of all existing constraint points along the drainage path

Off-site undeveloped areas are considered as "full build-out" for both the pre- and post-development analyses

Evaluation of peak discharges and velocities for the

Streambank protection storm (1-year, 24-hour storm)

Conveyance storm (25-year, 24-hour storm)

Flood mitigation storm (100-year, 24-hour storm)

Assessment of whether the post-development discharges are greater than the predevelopment discharges, whether the post-development velocities are greater than the predevelopment velocities; and whether the post-development velocities are greater than the allowed velocities for the receiving system.

After starting with a simple drainage area analysis using a topographic map, the zone of influence may need to be adjusted after running the pre- and post-development peak flows and velocities.

If it is shown that no peak flow increases occur downstream, and post-development velocities are acceptable, then control of the flood mitigation storm volume may be waived by the City Engineer. If peak discharges are increased by development, then an on-site structural control facility must be designed such that the post-development flows do not increase the peak flows, and the velocities are not erosive

- c. Where it is anticipated that additional runoff incidental to the development of the subdivision will overload an existing downstream drainage facility, whether natural or manmade, the Planning and Zoning Commission may withhold approval of the subdivision until appropriate provision has been made to accommodate the problem, and plans shall be provided which include all necessary off-site improvements including storm sewer systems, channel grading, driveway adjustments, culvert improvements, etc.
- d. In areas where downstream pipes or channels are inadequate to handle proposed increased flows, the city, as one alternative, may consider accepting cash payment in lieu of actual drainage improvements. The developer must show that the proposed pipe system to handle the flow from their development would not function properly without substantial downstream improvements. Prior to permitting any development that will significantly increase flood heights downstream or upstream, a hearing before the Planning and Zoning Commission is required with special notice to the adjacent property owners.

e. Streambank Protection

If the Downstream Assessment shows that the proposed project does not exceed acceptable downstream velocity or the downstream conditions are improved to adequately handle the increased velocity, then no additional streambank protection is required. If velocities exceed the allowable velocities, then one or more of the following options are required:

- (1) Option 1: Reinforce or stabilize downstream conditions using stone riprap, gabions, and/or bioengineered methods. Additional easements downstream may be required and conformance with Corps of Engineers permits is required.
- (2) Option 2: install Stormwater Controls to maintain existing Downstream Conditions to reduce post-development discharges at or below allowable velocity limits.
- (3) Option 3: Control the release of the 2-year, 24-hour storm to provide twenty-four hours of extended detention.

f. Flood Mitigation

When the downstream assessment shows an increase in flood volumes, the developer must address downstream flood mitigation using one of the following three options:

- (1) Option 1: Provide adequate downstream conveyance systems,
- (2) Option 2: Install stormwater Controls to maintain existing downstream conditions by providing detention designed and constructed so that there is no increase in downstream peak discharges or water surface elevations resulting from the development.
- (3) Option 3: In lieu of a downstream assessment, maintain existing on-site runoff conditions by providing detention that limits runoff from the development site to pre-development conditions. For many developments, the results of a downstream assessment may show that significantly less flood mitigation is required, as well as reducing the potential of exacerbating downstream flooding resulting from the timing of flood peaks. The developer must confirm that providing detention does not exacerbate peak flows in downstream reaches.

8. Drainage Facilities.

a. General

(1) Drainage facilities shall be provided and constructed as specified by the City Engineer. Hydraulic design procedures shall conform to the following methods where appropriate. The methodology selected is a function of the complexity of the hydraulic design and may use the following methods (or others if approved by the City Engineer.)

(a) Urban Hydrology for Small Watersheds, Technical Release No. 55 as prepared by the Soil Conservation Service, U. S. Department of Agriculture and hereinafter referred to as T.R. 55,

(b) Hydraulic Manual prepared and compiled by the Texas Department of Transportation Bridge Division.

(c) integrated Storm Water Manual, Hydraulics Technical manual ([http://iswm.nctcog.org/technical\\_manual.asp](http://iswm.nctcog.org/technical_manual.asp)).

(d) Manning's Equation for computing normal depths for flows confined to uniform cross-sections with free surface flow.

(e) The Hydraulic Gradient Method shall be used for closed conduit systems flowing full.

- (f) The HEC-2, Flood Plain Hydraulics, developed by the U.S. Army Corps of Engineers or WSP2 (Water Surface Profile 2) developed by the Soil Conservation Service will be used for non-uniform channel design or analysis and back water surface profiles.

Notwithstanding, all designs shall be in accordance with good engineering practices and are not to be limited to minimum criteria when it is deemed necessary for the welfare or safety of the public to implement more stringent requirements or criteria.

- (2) Approval of storm drain facilities necessary and construction requirements shall be the responsibility of the City Engineer. Where there is a question as to the justification of size of the facility required, the question will be resolved in favor of additional drainage capacity.
  - (3) All drainage structures shall be designed to convey the design storms specified and in such a manner that no ponding, pooling, erosion, sedimentation or other adverse condition would be created.
  - (4) All storm sewers, inlets, head walls and manholes in the drainage system shall be designed and built in accordance with the current City of Bastrop Construction Standards.
  - (5) All drainage facilities shall be constructed on public right-of-way or easements dedicated for the purpose. Drainage easements shall be of a sufficient size to permit access for maintenance of the drainage facility. The easement shall be designed to facilitate maintenance access to the drainage channel by city crews and equipment. Additional easements shall be required at any access points and the access points shall be designed to restrict access by unauthorized personnel. An access point will typically be required at every intersection of the drainage easement with street right-of-way.
  - (6) When a drainage channel or storm drain pipe, culvert or bridge is proposed, calculations shall be submitted showing basis for design and completed plans, profiles and specifications shall be submitted, showing complete construction details and detailed cost estimate.
  - (8) All drainage improvements shall be designed to an acceptable outfall as approved by the City Engineer.
  - (9) Off-Site Drainage.
    - (a) Adequate consideration shall be given by the owner in the development of property to determine how the discharge leaving the proposed development will affect adjacent property.
    - (b) On lots or tracts of three acres or more where storm water runoff has been collected or concentrated, it shall not be permitted to drain onto adjacent property except in existing creeks, channels or storm sewers unless proper drainage easements or notarized letters of permission from the affected property owners are provided. Such letters of permission shall be recorded in the property records of Bastrop County.
- b. Streets and Roads: Streets may be used for conveyance of surface runoff within the following standards:
- (1) Streets and Right-of-Way: Depth in the street shall not exceed top of curb or maximum flow spread limits for the conveyance storm (25-year storm), or no more than 6 inches of depth at the edge of pavement. The flood mitigation storm (100-year storm) shall be contained within the rights-of-way or easements.
  - (2) Flow Spread Limits: Inlets shall be spaced so that the spread of flow in the street for the conveyance storm (25-year) shall not exceed the guidelines listed in Table 10-15

below, as measured from the gutter or face of the curb:

<b>Table 10-15 Flow Spread Limits</b>	
<b>Street Classification</b>	<b>Allowable Encroachment</b>
Collectors, Arterial, and Thoroughfares (greater than 2-lanes)	<ul style="list-style-type: none"> <li>• 8 feet or one travel lane, both sides for a divided roadway</li> </ul>
Local Residential Streets	<ul style="list-style-type: none"> <li>• curb depth or maximum 6 inches at gutter while keeping one 11-foot travel lane open</li> </ul>

- (3) Where inlets are required, inlets shall be spaced so that the maximum travel distance of water in a gutter will not exceed six hundred (600) feet. Inlets will be sized using an allowable capacity of one (1) cubic foot per second of opening for a throat height of five (5) inches. Design of inlets shall conform to the City of Bastrop Construction Standards.
  - (4) Parking Lots: Parking lots shall be designed for the conveyance storm (25-year) not to exceed top of curb with maximum ponding at low points of one (1) foot. The flood mitigation storm (100-year) shall be contained on-site or within dedicated easements.
  - (5) Roadside Swales & Driveway Culverts
    - (a) Roadside drainage swales shall conform to the following:
      - Minimum grade - 0.5%
      - Maximum grade in sandy soils - 5%
      - Maximum grade in clay soils - 8%
    - (b) Rock or riprap retards shall be used to control the erosive characteristics of drainage in roadside swales on steep slopes. Retards shall be designed to reduce drainage water velocity to an acceptable level and to prevent drainage water from encroaching on the driving surface. Retards shall not project onto shoulder surfaces and shall blend into ditch lines so that normal roadside ditch maintenance is possible.
    - (c) Roadside swales shall be designed to carry the 25-year event, provided that the 100-year event is maintained in the right-of-way or an easement. Roadside swales (bar ditches) shall have a maximum front slope of 6:1 (horizontal: vertical). The maximum back-slope shall be 4:1 (horizontal: vertical). Exceptions to the slopes may be made by the City's Engineer for unusual circumstances, provided slopes are adequate for maintenance, soil stability and traffic safety.
    - (d) The design engineer shall calculate the culvert sizes for every lot within the subdivision and provide a table identifying each lot, culvert size and elevations. Corrugated metal pipe (CMP) is not an acceptable driveway culvert material.
    - (e) The length of culvert pipe, where used, shall be sufficient to allow for driveway base width (including radius as applicable) plus three times the pipe diameter plus three feet (3'), but in any case, no less than twenty feet (20'). All driveway culvert ends shall be constructed with concrete safety end treatments.
- c. Storm Sewers
- (1) All storm sewers, inlets, manholes or junctions shall be designed in accordance to Texas Department of Transportation hydraulic criteria.

(2) Design Frequency

- (a) Pipe Design: The conveyance storm (25-year) event within pipe with hydraulic grade line (HGL) below throat of inlets. In no case shall the system surcharge back through an inlet or inlets.
- (b) ROW and Easements: The flood mitigation storm (100-year) event must be contained within the ROW or easement.

(3) Design Criteria

- (a) For ordinary conditions, storm drain pipes shall be sized on the assumption that they will flow full or practically full under the design discharge but will not be placed under pressure head. Capacity of storm sewers shall be determined by using Manning's formula based on hydraulic gradients rather than physical slope of the pipe.
- (b) The maximum hydraulic gradient shall not produce a velocity that exceeds 15 feet per second (fps). Table 10-16 shows the desirable velocities for most storm drainage design. Storm drains shall be designed to have a minimum mean velocity flowing full at 2.5 fps.

<b>Description</b>	<b>Maximum Desirable Velocity (feet per second)</b>
Culverts (All types)	15
Storm Drains (Inlet laterals)	No Limit
Storm Drains (Collectors)	15
Storm Drains (Mains)	12

- (c) The minimum desirable physical slope shall be that which provides a minimum velocity of 2.5 feet per second.
- (d) If the hydraulic grade line elevation is less than one foot below ground elevation or gutter line for the design flow, adjustments are needed in the system to reduce the elevation of the hydraulic grade line.
- (e) Manholes: Manholes (inlets and junction boxes) shall be provided at all changes in grade or alignment of sewer intersections, and at a maximum of one thousand (1,000) feet on straight lines. Design of manholes shall conform to the current City of Bastrop Construction Standards, as periodically amended. Access manholes are required at intermediate points along straight runs of closed conduits. Table 10-17 gives maximum spacing criteria.

<b>Pipe Size (inches)</b>	<b>Maximum Spacing (feet)</b>
12-24	300
27-36	400
42-54	500
60 and up	600

- (f) Pipe: Pipe for storm drains shall be reinforced concrete pipe (RCP) in sizes as shown on the approved plans. The minimum size of the storm sewer shall be eighteen (18) inches and shall be reinforced concrete pipe minimum ASTM C76, Class III. Where, in the opinion of the City Engineer, added strength of pipe is needed for traffic loads over minimum cover or for excessive height of backfill, concrete pipe shall be ASTM C14 Extra Strength or ASTM C76, Class IV or Class V. Pipe shall have a minimum cover of not less than one (1) foot over the top of the pipe. Storm sewers will be required where subsurface conditions indicate a potential for seepage or underground flow as determined by the City Engineer. Alternate pipe materials may be used if the City Engineer determines they meet an equivalent or better performance criteria.
  - (g) The developer may install an approved open channel in lieu of installing pipe larger than sixty inches. This open channel shall be at the rear of residential lots and shall be adequately armored with a material approved by the city (e.g., concrete, rock gabions, etc.). In the event it is necessary to locate the drainage facility adjacent to and parallel to a street, it shall be a closed conduit even though pipe sizes larger than sixty inches are required.
  - (h) Outfalls: Whenever possible, outfalls from storm sewers and swales into natural drainage ways shall enter at the grade of the natural drainage channel. The engineer will design drop-type outfall structures, or otherwise provide adequate protection against erosion.
- d. Bridges and Culverts
- (1) For this Section, bridges are defined as cross drainage facilities with a span of 20 feet or larger.
  - (2) Design Frequency for Bridges:
    - (a) Flood mitigation storm (100-year) for all bridges
  - (3) Design Criteria for Bridges
    - (i) A freeboard of two feet shall be maintained between the computed design water surface and the low chord of all bridges.
    - (ii) The contraction and expansion of water through the bridge opening creates hydraulic losses. These losses are accounted for by using loss coefficients. Table 10-18 gives recommended values for the Contraction ( $K_c$ ) and Expansion ( $K_e$ ) Coefficients.
  - (4) For this Section, culverts are cross drainage facilities that transport runoff under roadways or other improved areas.
  - (5) Culvert hydraulics shall be analyzed using Federal Highway Administration (FHWA) Hydraulic Design Series Number 5 (HDS-5) HYDRAULIC DESIGN OF HIGHWAY CULVERTS methods.
  - (6) Box culverts shall conform to Texas Department of Transportation (TxDOT) design standards and details.

**Table 10-18 Recommended Loss Coefficients for Bridges**

<b>Transition Type</b>	<b>Contraction (<math>K_c</math>)</b>	<b>Expansion (<math>K_e</math>)</b>
No losses computed	0.0	0.0
Gradual transition	0.1	0.3
Typical bridge	0.3	0.5
Severe transition	0.6	0.8

Additional design guidance is in *Section 3.4 of the iSWM Hydraulics Technical Manual*.

(7) Design Frequency for Culverts

- (a) Culverts shall be designed for the flood mitigation storm (100-year) or in accordance with TxDOT requirements, whichever is more stringent. Consideration when designing culverts includes: roadway type, tailwater or depth of flow, structures, and property subject to flooding, emergency access, and road replacement costs. Culverts must convey the Conveyance Storm (25-year), and the headwater surface elevation shall not exceed the minimum road surface elevation. The headwater depth for a 100-year frequency storm shall not exceed one foot (1') over the minimum roadway surface elevation.
- (b) The flood mitigation storm (100-year) shall be routed through all culverts to be sure building structures (e.g., houses, commercial buildings) are not flooded or increased damage does not occur to the highway or adjacent property for this design event.

(8) Design Criteria for Culverts

(a) Velocity Limitations

- (i) The maximum velocity shall be consistent with channel stability requirements at the culvert outlet.
- (ii) The maximum allowable velocity for corrugated metal pipe is 15 feet per second. There is no specified maximum allowable velocity for reinforced concrete pipe, but outlet protection shall be provided where discharge velocities will cause erosion conditions.
- (iii) To ensure self-cleaning during partial depth flow, a minimum velocity of 2.5 feet per second is required for the streambank protection storm when the culvert is flowing partially full.

(a) Length and Slope

- (i) The maximum slope using concrete pipe is ten percent (10%) and for CMP is fourteen percent (14%) before pipe-restraining methods must be taken.
- (ii) Maximum vertical distance from throat of intake to flowline in a drainage structure is 10 feet (10').
- (iii) Drops greater than four feet (4') will require additional structural design.

(b) Headwater Limitations: The allowable headwater is the depth of water that can be ponded at the upstream end of the culvert during the design flood, which will be limited by one or more of the following constraints or conditions:

- (i) Headwater will be non-damaging to upstream property.
- (ii) Culvert headwater plus twelve inches (12") of freeboard shall not exceed top of curb or pavement for low point of road over culvert, whichever is lower.
- (iii) Ponding depth will be no greater than the elevation where flow diverts around the culvert.
- (iv) Elevations will be established to delineate necessary floodplain easements.
- (v) The headwater shall be checked for the flood mitigation storm elevation to ensure compliance with flood plain management criteria and the culvert shall be sized to maintain flood-free conditions on major thoroughfares with twelve-inch (12") freeboard at the low-point of the road.
- (vi) Either the headwater shall be set to produce acceptable velocities or stabilization/energy dissipation shall be provided where these velocities are exceeded.

(vii) In general, the constraint that gives the lowest allowable headwater elevation establishes the criteria for the hydraulic calculations.

(c) Tailwater Considerations

- (i) If the culvert outlet is operating with a free outfall, the critical depth and equivalent hydraulic grade line shall be determined.
  - (ii) For culverts that discharge to an open channel, the stage-discharge curve for the channel must be determined. See *Section 2.1.4 of the iSWM Hydraulics Technical Manual* on methods to determine a stage- discharge curve.
  - (iii) If an upstream culvert outlet is located near a downstream culvert inlet, the headwater elevation of the downstream culvert will establish the design tailwater depth for the upstream culvert.
  - (iv) If the culvert discharges to a lake, pond, or other major water body, the expected high-water elevation of the water body will establish the culvert tailwater.
- (d) Other Criteria
- (i) In designing debris control structures, the Hydraulic Engineering Circular No. 9 entitled *Debris Control Structures* or other approved reference is required to be used.
  - (ii) If storage is being assumed or will occur upstream of the culvert, refer to *Section 2.0 of the iSWM Hydraulics Technical Manual* regarding storage routing as part of the culvert design.
  - (iii) Reinforced concrete pipe (RCP), pre-cast and cast-in-place concrete boxes are recommended for use:
    - (1) under a roadway,
    - (2) when pipe slopes are less than one percent (1%), or
    - (3) for all flowing streams. RCP and fully coated corrugated metal pipe or high-density polyethylene (HDPE) pipe may also be used in open space areas.

Use of any storm drain pipe other than RCP shall have prior approval from the City.
  - (iv) Culvert skews shall not exceed forty-five degrees (45°) as measured from a line perpendicular to the roadway centerline without approval.
  - (e) The minimum allowable pipe size for a storm drain main shall be twenty-four inches (24"). Eighteen-inch (18") pipe may be used for storm drain lead lines with approval from City.
  - (f) Erosion, sediment control, and velocity dissipation shall be designed in accordance with *Section 4.0 of the Hydraulics Technical Manual*.
- (9) Headwalls and Wingwalls
- (a) All headwall and wingwalls shall conform to TxDOT design standards and details.
  - (b) No headwall, wingwall or other structural member shall protrude above the surface of the traveled roadway.
  - (c) All headwall and wingwalls within the "clear zone" as defined by TxDOT of any roadway shall conform to TxDOT design standards and details for safety end treatment or shall be protected by a traffic barrier.
- e. Drainage Channels
- (1) Design Frequency
- (a) Open channels, including all natural or structural channels, swales, and swales shall be designed for the flood mitigation storm event (100-year)
  - (b) Channels shall be designed with multiple stages. A low flow channel section containing the streambank protection flows (2-year) and a high flow section that contains the conveyance (25-year) and flood mitigation storms (100-year) will improve stability and better mimic natural channel dimensions.



(2) Design Criteria

- (a) Open channels shall incorporate meanders to the maximum extent practical; however, the two-year peak flow shall be conveyed in a channel with the following meander configuration:
  - (i) Channel sinuosity shall exceed 1.5,
  - (ii) The angle between the channel centerline and the valley axis is less than 90 degrees,
  - (iii) Sinusoidal curvature patterns may be regular or irregular, and
  - (iv) The ratio of the design radius of curvature to the channel width shall be between 1.5 and 4.5.
- (b) If the channel slope exceeds ten percent (10%), or a combination of channel linings will be used, additional procedures not presented below are required. References include HEC-15 (USDOT, FHWA, 1986) and HEC-14 (USDOT, FHWA, 1983).
- (c) HEC-RAS, or similarly capable software approved by the entity with jurisdiction, shall be used to confirm the water surface profiles in open channels.
- (d) The final design of artificial open channels shall be consistent with the velocity limitations for the selected channel lining. Maximum velocity values for selected lining categories are presented in Table 10-19. Seeding and mulch shall only be used when the design value does not exceed the allowable value for bare soil. Velocity limitations for vegetative linings are reported in Table 10-19. Vegetative lining calculations and stone riprap procedures are presented in *Section 3.2 of the iSWM Hydraulics Technical Manual*.
- (e) Drainage swales, where approved by the City Council, may be used for outfalls to natural or major drainage channels. Swales shall be designed to have a minimum of one (1) foot of freeboard at design flow and side slopes shall not be steeper than 3:1.
- (f) Channels with slopes less than one percent (1.0%) shall be constructed with a reinforced concrete pilot channel, unless other low flow methods are approved by the City Engineer.
- (g) Water surface profiles for all channels shall be computed using a standard step backwater model, such as US Army Corps of Engineers (USACE) HEC-RAS. The engineer can propose to use other hydraulic methods but must have their acceptability approved by the City Engineer.
- (h) Open channels shall meet the criteria of either the Texas State Department of Highways and Public Transportation or S.C.S. TR. No. 25 Design of Open Channels and shall be constructed in accordance with one of the design methods. Design of channels shall consider velocities and shall be shaped, graded, lined, or protected to minimize or prevent scour and erosion from excessive velocities. This requirement shall extend to roadside drainage swales. Concrete or rock retards shall be used when velocities exceed four feet (4') per second with sandy soil conditions or five feet (5') per second with clay soil conditions. All channels or roadside drainage swales without a protective lining shall have an established vegetative or grass cover. The depth of the 100-year frequency storm runoff shall not exceed one foot (1') over the minimum roadway surface elevation.
- (i) The applicant may be required by the City Engineer to carry away by pipe or open ditch any spring or surface water that exists prior to, or because of the subdivision. Such drainage facilities shall be located in the road right-of-way where feasible, or in the perpetual unobstructed drainage easements of

<b>Table 10-19 Roughness Coefficients (Manning's n) and Allowable Velocities for Natural Channels</b>		
<b>Channel Description</b>	<b>Manning's n</b>	<b>Max. Permissible Channel Velocity (ft/s)</b>
<b>MINOR NATURAL STREAMS</b>		
Fairly regular section		
1. Some grass and weeds, little or no brush	0.030	3 to 6
2. Dense growth of weeds, depth of flow materially greater than weed height	0.035	3 to 6
3. Some weeds, light brush on banks	0.035	3 to 6
4. Some weeds, heavy brush on banks	0.050	3 to 6
5. Some weeds, dense willows on banks	0.060	3 to 6
For trees within channels with branches submerged at high stage, increase above values by Irregular section with pools, slight channel meander, increase above values by	0.010	
	0.010	
Floodplain – Pasture		
1. Short grass	0.030	3 to 6
2. Tall grass	0.035	3 to 6
Floodplain – Cultivated Areas		
1. No crop	0.030	3 to 6
2. Mature row crops	0.035	3 to 6
3. Mature field crops	0.040	3 to 6
Floodplain – Uncleared		
1. Heavy weeds scattered brush	0.050	3 to 6
2. Wooded	0.120	3 to 6
<b>MAJOR NATURAL STREAMS</b>		
Roughness coefficient is usually less than for minor streams of similar description because of less effective resistance offered by irregular banks or vegetation on banks. Values of "n" for larger streams of mostly regular sections, with no boulders or brush	Range from 0.028 to 0.060	3 to 6
<b>UNLINED VEGETATED CHANNELS</b>		
Clays (Bermuda Grass)	0.035	5 to 6
Sandy and Silty Soils (Bermuda Grass)	0.035	3 to 5
<b>UNLINED NON-VEGETATED CHANNELS</b>		
Sandy Soils	0.030	1.5 to 2.5
Silts	0.030	0.7 to 1.5
Sandy Silts	0.030	2.5 to 3.0
Clays	0.030	3.0 to 5.0
Coarse Gravels	0.030	5.0 to 6.0
Shale	0.030	6.0 to 10.0
Rock	0.025	15
For natural channels with specific vegetation type, refer to Table 3.11 for more detailed velocity control.		

appropriate width and shall be constructed in accordance with the construction standards and specifications of the city of Bastrop.

- (j) Trapezoidal channels shall have a minimum channel bottom width of six feet (6').
- (k) Channels with bottom widths greater than six feet (6') shall be designed with a minimum bottom cross slope of 12 to 1 (12:1) or with compound cross sections.
- (l) Channel side slopes shall be stable throughout the entire length and the side slope shall depend on the channel material. Channel side slopes and roadside swales with a side slope steeper than 3:1 shall require detailed geotechnical and slope stability analysis to justify slopes steeper than 3:1; however, any slope that is less than 3:1 needs a detailed analysis to prove that it will work.
- (m) Trapezoidal or parabolic cross sections are preferred over triangular shapes.
- (n) For vegetative channels, design stability shall be determined using low vegetative retardance conditions (Class D). For design capacity, higher vegetative retardance conditions (Class C) shall be used.
- (o) For vegetative channels, flow velocities within the channel shall not exceed the maximum permissible velocities given in Tables 10-19 and 10-20.
- (p) If relocation of a stream channel is unavoidable, the cross-sectional shape, meander, pattern, roughness, sediment transport, and slope shall conform to the existing conditions insofar as practicable. Energy dissipation will be necessary when existing conditions cannot be duplicated.
- (q) Streambank stabilization shall be provided, when appropriate, as a result of any stream disturbance such as encroachment and shall include both upstream and downstream banks as well as the local site.
- (r) Vegetative Design: A two-part procedure is required for final design of temporary and vegetative channel linings.
  - i. Part 1- the design stability component, involves determining channel dimensions for low vegetative retardance conditions, using Class D as defined in Table 10-21.
  - ii. Part 2: the design capacity component, involves determining the depth increase necessary to maintain capacity for higher vegetative retardance conditions, using Class C as defined in Table 10-21.
  - iii. If temporary lining is to be used during construction, vegetative retardance Class E shall be used for the design stability calculations.
- (s) For gabions, design velocities range from 10 fps for 6-inch mattresses up to fifteen feet per second (15 fps) for one-foot (1') mattresses. Some manufacturers indicate that velocities of twenty feet per second (20 fps) are allowable for basket installations. The design of stable rock riprap lining depends on the intersection of the velocity (local boundary shear) and the size and gradation of the riprap material. More information on calculating acceptable riprap velocity limits is available in *Section 3.2.7 of the Hydraulics Technical Manual*.
- (t) Swales: Drainage swales, where approved by the City Council, may be used for outfalls to natural or major drainage channels. Swales shall be designed to have a minimum of one foot (1') of freeboard at design flow and side slopes shall not be steeper than 3:1 and constructed with a reinforced concrete trickle channel.
- (u) A permanent chain link fence or other fence meeting the requirements of the city shall be constructed along the top of any channel exceeding three feet (3') in depth to enclose the area where it is adjacent to residential lots and in other cases, where it is deemed necessary to restrict access to the channel.

<b>Vegetation Type</b>	<b>Slope Range (%)<sup>1</sup></b>	<b>Maximum Velocity<sup>2</sup> (ft/s)</b>
Bermuda grass	0-5	6
Bahia		4
Tall fescue grass mixtures <sup>3</sup>	0-10	4
Kentucky bluegrass	0-5	6
Buffalo grass	5-10 >10	5 4
Grass mixture	0-5 <sup>1</sup> 5-10	4 3
Sericea lespedeza, Weeping lovegrass, Alfalfa	0-5 <sup>4</sup>	3
Annuals <sup>5</sup>	0-5	3
Sod		4
Lapped sod		5
<sup>1</sup> Do not use on slopes steeper than 10% except for side-slope in combination channel. <sup>2</sup> Use velocities exceeding 5 ft/s only where good stands can be maintained. <sup>3</sup> Mixtures of Tall Fescue, Bahia, and/or Bermuda <sup>4</sup> Do not use on slopes steeper than 5% except for side-slope in combination channel. <sup>5</sup> Annuals - used on mild slopes or as temporary protection until permanent covers are established.		

Source: Manual for Erosion and Sediment Control in Georgia, 1996.

f. Detention/Retention Structures

(1) General

- (a) Retention (maintains a permanent pool elevation) and detention (no permanent pool storage) shall be designed in accordance with the criteria below.
- (b) Stormwater detention facilities shall be required where deemed appropriate by the City when it is determined that adverse downstream flooding would occur due to a proposed development. Stormwater detention shall be used to reduce the net increase in stormwater runoff due to development of the property at the 2, 25, 50 and 100-year events, unless a downstream assessment shows that none is required. Multi-stage outlet structures may be required.
- (c) Retention/detention ponds shall be encompassed by an easement. The facility will remain the maintenance responsibility of the owner/developer or property-owners association, unless otherwise accepted by the city. Acceptance by the city will be contingent upon the facility being a part of a dedicated park or other such property which meets with the city's approval.
- (d) Preservation of major floodplains is strongly encouraged and detention/retention may be required if a proposed drainage improvement is found to create actual or potential upstream, adjacent or downstream property damage due to the creation of excessive flood velocities or heights.

<b>Retardance Class</b>	<b>Cover</b>	<b>Condition</b>
A	Weeping Lovegrass	Excellent stand, tall (average 30")
	Yellow Bluestem Ischaemum	Excellent stand, tall (average 36")
B	Kudzu	Very dense growth, uncut
	Bermuda grass	Good stand, tall (average 12")
	Native grass mixture Little bluestem, bluestem, blue gamma other short and long stem Midwest grasses	Good stand, unmowed
	Weeping lovegrass	Good stand, tall (average 24")
	Laspedeza sericea	Good stand, not woody, tall (average 19")
	Alfalfa	Good stand, uncut (average 11")
	Weeping lovegrass	Good stand, unmowed (average 13")
	Kudzu	Dense growth, uncut
C	Blue gamma	Good stand, uncut (average 13")
	Crabgrass	Fair stand, uncut (10 – 48")
	Bermuda grass	Good stand, mowed (average 6")
	Common lespedeza	Good stand, uncut (average 11")
	Grass-legume mixture: summer (orchard grass redtop, Italian ryegrass, and common lespedeza)	Good stand, uncut (6 – 8 ")
	Centipede grass	Very dense cover (average 6")
	Kentucky bluegrass	Good stand, headed (6 – 12")
D	Bermuda grass	Good stand, cut to 2.5"
	Common lespedeza	Excellent stand, uncut (average 4.5")
	Buffalo grass	Good stand, uncut (3 – 6")
	Grass-legume mixture: fall, spring (orchard grass, redtop, Italian ryegrass, and common lespedeza)	Good stand, uncut (4 – 5")
	Lespedeza serices	After cutting to 2" (very good before cutting)
	E	Bermuda grass
Bermuda grass		Burned stubble

Note: Covers classified have been tested in experimental channels. Covers were green and generally uniform.  
Source: HEC-15, 1988.

- (e) Runoff from sites larger than one acre must not exceed pre-development levels for the two-year, twenty-five-year and one hundred-year twenty-four-hour events, unless a downstream assessment determines that it is not required. Multi-phase developments will be considered as a single entity in determining the requirement for detention.

- (f) No increase or concentration of storm water may be conveyed off-site without easements and/or downstream drainage improvements. Increased storm water runoff attributable to new development must not exceed the capacity of the downstream drainage system. If no downstream drainage system exists, increased storm water runoff must not adversely affect adjoining property. In cases where the proposed runoff would exceed the capacity of downstream facilities, the developer will be required to provide detention to prevent overloading of downstream systems.
- (g) In all new developments where storm water runoff has been collected or concentrated, discharge shall be conveyed off-site by creeks, channels or storm sewer systems. Easements shall be provided by the developer to the city for off-site drainage facilities, as well as for on-site facilities. All flows shall be discharged in a non-erosive manner.
- (h) The developer shall pay for the cost of all drainage improvements required, including any necessary off-site channels or storm sewers and acquisition of the required easements.
- (i) If it is anticipated that additional runoff caused by the development will overload any existing downstream drainage facility, whether natural or improved, and result in hazardous conditions, approval of the improvements for the proposed subdivision may be withheld until appropriate provision has been made to accommodate the problem. If existing capacity is not available downstream and property damage could occur, the owner or developer shall provide a drainage system or detention facility to mitigate the deficiency. In any case, a letter of acknowledgement shall be obtained from the downstream property owner indicating that the downstream property owner is aware of proposed drainage improvements impacting drainage on or to said owner's property.
- (j) Permanent impoundments of water shall be constructed in such a way that negative effects on aesthetics, function, flooding, health, and safety are minimized. Such improvements shall be allowed at the discretion of the City Engineer. The developer shall be responsible for all necessary permitting required by the Texas Commission on Environmental Quality for impounding public water. The City Engineer may require calculations and/or other documentation that no negative impact is created. All Texas Commission on Environmental Quality (TCEQ) requirements for impoundments and dam safety shall apply. These requirements relate to both the size and the hazard classification of the embankment. Copies of all materials submitted to TCEQ for permitting, along with the TCEQ permits, must be submitted to the City Engineer.
- (k) All storage facilities serving drainage areas greater than fifty (50) acres shall be designed and analyzed using reservoir routing of an inflow unit hydrograph. The software program or computational method must be approved by the City Engineer. The analysis should consist of comparing the design flows at a point or points downstream of the proposed storage site with and without storage. Design calculations shall show the effects of the detention facility in each of the two-, ten-, twenty-five-, and one hundred-year storm events. This may require the use of multi-stage control structures. The detention facility shall be designed to provide the required detention for all the above-listed frequencies.
- (l) Detention storage facilities serving drainage areas smaller than fifty (50) acres may use the modified rational method or unit hydrograph method for storage calculations. All calculations must be provided to the City Engineer for review and approval.
- (m) The facilities shall be designed in accordance with SCS-TR-55 or by other approved methods.

- (n) Detention ponds may be counted toward the required parkland dedication if designed to accommodate recreational activities.
- (2) Design Frequency  
Detention structures shall be designed for the three storms (streambank protection (2-year), conveyance (25-year), and flood mitigation storms (100-year)) for the critical storm duration that results in the maximum (or near maximum) peak flow.
- (3) Design Criteria
- (i) Dry detention basins are sized to temporarily store the volume of runoff required to provide flood protection up to the flood mitigation storm, if required.
  - (ii) Extended detention dry basins are sized to provide extended detention of the streambank protection volume over 24 hours and can also provide additional storage volume for normal detention (peak flow reduction) of the flood mitigation storm event.
  - (iii) Routing calculations must be used to demonstrate that the storage volume and outlet structure configuration are adequate. See *Section 2.0 of the iSWM Hydraulics Technical Manual* for procedures on the design of detention storage.
  - (iv) Detention Basins shall be designed with an 8-foot-wide maintenance access.
  - (v) No earthen (grassed) embankment slopes shall exceed 4:1.
  - (vi) A freeboard of one (1) foot will be required for all detention ponds.
  - (vii) A calculation summary shall be provided on construction plans. For detailed calculations of unit hydrograph studies, a separate report shall be provided to the municipality for review and referenced on the construction plans. Stage-storage-discharge values shall be tabulated and flow calculations for discharge structures shall be shown on the construction plans.
  - (viii) An emergency spillway shall be provided at the flood mitigation maximum storage elevation with sufficient capacity to convey the flood mitigation storm assuming blockage of the outlet works with six inches of freeboard. Spillway requirements must also meet all appropriate state and Federal criteria.
  - (ix) A landscape plan shall be provided for all detention ponds.
  - (x) All detention basins shall be stabilized against significant erosion and include a maintenance plan.
  - (xi) Design calculations will be provided for all spillways and outlet structures.
  - (xii) Maintenance agreements shall be included for all detention structures.
  - (xiii) Storage may be subject to the requirements of the Texas Dam Safety Program (see iSWM Program Guidance) based on the volume, dam height, and level of hazard.
  - (xiv) Earthen embankments six feet (6') in height or greater shall be designed per Texas Commission on Environmental Quality guidelines for dam safety (see iSWM Program Guidance).
  - (xv) Vegetated slopes shall be less than twenty feet (20') in height and shall have side slopes no steeper than 2:1 (horizontal to vertical) although 3:1 is preferred. Riprap-protected slopes shall be no steeper than 2:1. Geotechnical slope stability analysis is recommended for slopes greater than ten feet (10') in height. Vegetated slopes with a side slope steeper than 2:1 shall require detailed geotechnical and slope stability analysis to justify slopes steeper than 2:1.
  - (xvi) Areas above the normal highwater elevations of the detention facility should be sloped toward the basin to allow drainage and to prevent standing water. Careful finish grading is required to avoid creation of upland surface depressions that may retain runoff. The bottom area of storage facilities should be graded toward the outlet to prevent standing water conditions. A low flow or pilot channel across the facility bottom from the inlet to the outlet (often constructed with riprap) is recommended to convey low flows and prevent standing water conditions.

(4) Outlet Structures

- (a) Outlet structures shall be designed to intercept sediment and floatables from the twenty-five-year storm. The potential for the impact of sedimentation on the detention facility should be evaluated. A means of access for maintenance of the facility shall be provided.
- (b) The outlet control structures for storage facilities typically include a principal outlet and an emergency overflow. The principal outlet functions to restrict the outflow and cause the runoff to use the available storage volume. The principal outlet shall be designed to accommodate the multiple frequency storms listed above while maintaining the minimum freeboard of one foot. The emergency overflow shall be paved and provide positive overflow.
- (c) The outlet control structure may be drop inlets, pipes, culverts, weirs, or orifices. Checks should be made to determine if the outlet structure is controlled by weir or orifice flow. The tailwater on the structure could significantly affect its capacity. The engineer should carefully evaluate the tailwater depth. For detention facilities in a series, the lower facility should not cause inundation of the upper outlet control structure. The calculation of the hydraulic capacity for outlet control structures is based on the type of structure used, using standard hydraulic calculations.
- (d) Extended detention (ED) orifice sizing is required in design applications that provide extended detention for downstream streambank protection (2-year) or the ED portion of the water quality protection volume. The release rate for both the  $WQ_v$  and  $SP_v$  shall discharge the ED volume in a period of 24 hours or longer. In both cases an extended detention orifice or reverse slope pipe must be used for the outlet. For a structural control facility providing both  $WQ_v$  extended detention and  $SP_v$  control (wet ED pond, micropool ED pond, and shallow ED wetland), there will be a need to design two outlet orifices – one for the water quality control outlet and one for the streambank protection drawdown.
- (e) Design Frequency
  - Water quality storm (1.5 inches of rainfall)
  - Streambank protection storm (2-year, 24-hour)
  - Conveyance storm (25-year, 24-hour)
  - Flood mitigation storm (100-year, 24-hour)
- (f) Design Criteria
  - (i) Estimate the required storage volumes for water quality protection, streambank protection, conveyance storm, and flood mitigation.
  - (ii) Design extended detention outlets for each storm event.
  - (iii) Outlet velocities shall be within the maximum allowable range based on channel material as shown in Tables 10-19 and 10-20.
  - (iv) Design necessary outlet protection and energy dissipation facilities to avoid erosion problems downstream from outlet devices and emergency spillway(s).
  - (v) Perform buoyancy calculations for the outlet structure and footing. Flotation will occur when the weight of the structure is less than or equal to the buoyant force exerted by the water.
  - (vi) Additional design guidance is in *Section 2.2 of the iSWM Hydraulics Technical Manual*.

(5) Energy Dissipation

- (a) Design Frequency
  - All drainage system outlets, whether for closed conduits, culverts, bridges, open



channels, or storage facilities, shall provide energy dissipation to protect the receiving drainage element from erosion.

- (i) Conveyance storm
- (ii) Flood mitigation storm

(b) Design Criteria

- (i) *Energy dissipaters* are engineered devices such as rip-rap aprons or concrete baffles placed at the outlet of storm water conveyance systems for reducing the velocity, energy and turbulence of the discharged flow.
- (ii) Erosion problems at culvert, pipe and engineered channel outlets are common. Determination of the flow conditions, scour potential, and channel erosion resistance shall be standard procedure for all designs.
- (iii) Energy dissipaters shall be employed whenever the velocity of flows leaving a stormwater management facility exceeds the erosion velocity of the downstream area channel system.
- (iv) Energy dissipater designs will vary based on discharge specifics and tailwater conditions.
- (v) Outlet structures shall provide uniform redistribution or spreading of the flow without excessive separation and turbulence.
- (vi) Energy dissipaters are a required component of the *iSWM Construction Plan*.
- (vii) Recommended Energy Dissipaters for outlet protection include the following:
  - Riprap apron
  - Riprap outlet basins
  - Baffled outlets
  - Grade Control Structures

The reader is referred to *Section 4.0 of the iSWM Hydraulics Technical Manual* and the Federal Highway Administration Hydraulic Engineering Circular No. 14 entitled, Hydraulic Design of Energy Dissipaters for Culverts and Channels, for the design procedures of other energy dissipaters.

10.36.070 – Utilities

A. General

1. Unless otherwise approved by the City Engineer, utilities shall be in the standardized locations as provided in the city of Bastrop design standards and criteria. All pressurized utility systems (water, gas, etc.) shall be located behind the curb line wherever possible.
2. Utility Lines Under Pavement. All water, sewer, and natural gas utility lines and conduit for electrical, telephone, and cable television that pass under a street or alley shall be installed before the street or alley is paved. When it is necessary that utility lines pass under the street or alley pavement, they shall be installed to a point at least three feet beyond the edge of the pavement.
3. Existing overhead electric transmission lines and primary feeder circuits are not required to be relocated to underground facilities; however, all services from existing primary feeder circuits must be underground. Underground utilities will also be required in new subdivisions outside the city which will be requesting annexation to receive city water and sewer service.

B. Water

1. General:

- a. The subdivider shall provide all water lines necessary to properly serve each lot of the subdivision and ensure that existing, and/or new water facilities can supply the required

demand for domestic use and for fire protection at the desired pressure. The subdivider shall bear all costs for extending water service from existing City water lines to the subdivision.

- b. All water systems shall conform to the City of Bastrop's Construction Standards Manual and all applicable TCEQ standards and regulations. All water lines and service connections shall meet the current City of Bastrop Construction Standards. The subdivider shall submit a certificate to the City Engineer certifying that the system has been designed in accordance with the current requirements of the TCEQ and the City of Bastrop.
  - c. All public water main lines must comply with the master water distribution plan.
  - d. All water lines shall extend across the full width of the lot, in an alignment that will allow for extension to the adjacent property in accordance with city regulations and the master water distribution plan. Properties already served by water shall not be required to install additional facilities unless the existing lines are not of adequate capacity to serve the proposed development, in which case the developer shall be required to install adequate facilities.
2. Water Lines: Piping for water mains and connections shall be ductile iron or AWWA C-900 polyvinyl chloride pipe. Service piping shall be copper for all commercial services and polyethylene for all residential services as approved by the City Engineer. All pipe and fittings shall be new and unused. All pipe and fittings shall conform to the latest standards of the American Water Works Association.
    - a. Minimum size of water mains shall be not less than six inches (6") in diameter for looped systems and not less than eight inches (8") for systems or portions of systems that dead end.
    - b. Larger lines shall be installed when required by the City Engineer and so noted in the preliminary plat or final plat review.
  3. Valves: At intersections of water distribution lines, the number of valves shall be one less than the number of radiating lines (two valves for tee connection and three for cross connection). Valves shall be located at the P.C. or P.T. of the nearest property line. All valves shall conform to the latest standards of the American Water Works Association.
  4. Fire Hydrants: Standard fire hydrants shall be installed as part of the water distribution system in accordance with specifications of the State Board of Insurance and the City of Bastrop. Fire hydrants shall be located so that no residential lot is located more than six hundred feet (600') from a fire hydrant, as measured along the centerline of the street on which the lot fronts (measuring from the corner of the lot to the hydrant). Commercial and industrial areas shall have fire hydrants spaced at three hundred feet (300'). The spacing and location of fire hydrants is subject to approval of the city fire marshal. All hydrants shall be standard three-way post-type dry barrel hydrants complying to AWWA Standards with six (6) inch or larger connections to mains. Fire hydrants shall be in accordance with current City of Bastrop Construction Standards. Threading on fire hydrant outlets shall be the National Standard Hose Threads.
  5. All water meters shall be located within dedicated right-of-way or an easement adjacent to public streets, alleys or access easements.
  6. Paving cuts for installation of water lines shall comply with the City of Bastrop Construction Standards.

#### C. Wastewater

1. General
  - a. All subdivisions shall be provided with an approved wastewater collection and/or sewage disposal system.

- b. Connection with the sanitary sewer system shall be required except where the City Engineer determines that such connection will require unreasonable expenditure when compared with other methods of sewage disposal and that alternate methods will protect public health and water quality. Where septic systems are installed, the subdivider shall conduct percolation tests under the supervision of the Bastrop County Health Department to determine the adequacy of proposed lot sizes.
  - c. All public sewer main lines must comply with the master wastewater collection plan.
  - d. All wastewater lines shall extend across the full width of the lot, in an alignment that will allow for extension to the adjacent property in accordance with city regulations and the master water distribution plan. Properties already served by water shall not be required to install additional facilities unless the existing lines are not adequate to serve the proposed development, in which case the developer shall be required to install adequate facilities.
2. On-Site Wastewater Systems
- a. On-site Sanitary Sewer Facilities (OSSFs, or septic tanks) will not be permitted within a new City Subdivision.
  - b. Rural Subdivisions using OSSF systems for wastewater service shall conform to all applicable TCEQ and Bastrop County Health Department OSSF regulations.
3. Public and/or Private Centralized Collection and Treatment Systems
- a. Subdivisions utilizing public wastewater collection and treatment systems shall conform to all applicable TCEQ and City of Bastrop utility and wastewater regulations.
  - b. The subdivider shall provide all sewer lines necessary to properly serve each lot of the subdivision and ensure that existing lines and facilities can adequately serve the proposed subdivision. The subdivider shall bear all costs for extending existing City sewer lines and facilities to service the proposed subdivision. All sewer lines and service connections shall meet the current City of Bastrop Construction Standards. Connection to the City's wastewater collection system shall only be permitted if the recipient of City sewer service is also a recipient of City of Bastrop water service at the location being connected.
    - (1) Sewer Lines: Piping for sewer lines shall be polyvinyl chloride (PVC) with elastomeric joints. Sewer lines shall conform to the requirements of the TCEQ. Minimum sewer pipe size shall be six (6) inch diameter. Minimum house connection size shall be four (4) inch diameter. All pipe and accessories shall be new. All pipe shall be installed in accordance with current City of Bastrop Construction Standards.
    - (2) Sewer Manholes: Sewer manholes shall be minimum four (4) feet in diameter. Steps shall not be provided. Manholes may be precast or cast-in-place concrete. Manhole covers and frames shall weigh a minimum of two hundred fifty pounds (250#) in non-traffic areas and a minimum of three hundred fifty pounds (350#) in traffic areas. The outside diameter of the lid shall be twenty-four inches (24"). Lids shall be solid with no pick holes. The words "sanitary sewer" shall be cast into the lid surface. Manholes shall be constructed at all changes in sewer line direction but in no case shall the distance between manholes exceed five hundred feet (500'). All manholes shall be installed in accordance with current City of Bastrop Construction Standards.
- D. Electric, Telephone and Cable TV Utilities
1. General
- a. All electric lines and facilities shall be in conformance with the requirements of the appropriate electrical provider (Bastrop Power and Light or Bluebonnet Electric).
  - b. All electrical and telecommunication support equipment (transformers, amplifiers, switching devices, etc.) necessary for underground installations shall be pad-mounted or placed underground, within an easement, and screened from view, but not in a way that obstructs the vision of motorists at street, alley, or driveway intersections.

2. Underground Electrical, Telephone, and Cable Television Utilities. All new telephone, cable television, and electrical utility lateral and service lines shall be placed underground throughout new subdivisions for which final plats are approved after the effective date of the ordinance codified in this chapter, subject to the following conditions:
  - a. All electrical transmission lines, meaning those electrical lines operated at nominal voltages of sixty thousand (60,000) volts or higher, may be placed overhead;
  - b. Any electric distribution lines, meaning those electrical lines that emanate from substations to distribute power throughout an area, may be placed overhead. Subdivisions located within commercial corridors shall provide sufficient easement to locate feeders at the rear of lots, away from arterial frontage, wherever possible;
  - c. Lateral electric lines, meaning those electric lines that emanate from an electric feeder line and are used to distribute power to small areas of electric consumers, and service lines, meaning those electric lines which through a transformer connect a lateral line to a customer's service entrance, may be placed overhead only when they are located along rear property lines to provide service from the rear of the lot. Generally, perpendicular overhead street crossings are permitted when connecting rear lateral lines in one block to rear lateral lines in an adjacent block;
  - d. Any electric distribution or transmission line crossing any interstate highway may be placed overhead;
  - e. Where electrical service is to be placed underground, electrical service for street or site lighting shall also be placed underground except for the lighting standards;
  - f. Temporary electrical service during construction may be provided by overhead utility lines and facilities prior to activation of the underground service. Following activation of the underground permanent service, the temporary overhead electrical service shall be removed within sixty days;
  - g. The electrical utility company may plan and construct overhead lines on perimeters of subdivisions or property without obtaining a variance. Telephone and cable television lines may be constructed overhead where overhead electric utility lines are permitted;
  - h. Each of the utility companies shall be responsible for developing administrative policies and cost reimbursement procedures for the installation and extension of their underground utilities. Nothing in this chapter shall prohibit or restrict any utility company from recovering the difference in cost of overhead facilities and underground utilities from the owner or developer in accordance with the provisions of such utility's approved tariff. No utility company shall be required to begin construction of underground facilities unless and until the owner or developer of the subdivision has made arrangements satisfactory to the specific utility company for the payment of such underground facilities. If the Planning and Zoning Commission denies a waiver for overhead construction under subsection j. below) of this section, the city council may, by the affirmative vote of at least three-fourths of its members determine that the developer should not pay the difference in cost between overhead and underground construction by overruling the Planning and Zoning Commission and granting a waiver. The City of Bastrop shall not be responsible for any portion of such cost unless specifically authorized by the City Council;
  - i. All electrical, cable television and telephone support equipment (transformers, amplifiers, switching devices, etc.) necessary for underground installation shall be pad-mounted or placed underground and the difference in cost of such facilities and overhead facilities shall be paid to the installing utility company in accordance with provisions established under subsection i. above of this section;
  - j. In special or unique circumstances, or to avoid undue hardship, the Planning and Zoning Commission may authorize waivers in conjunction with plat approval to the requirements to provide underground facilities;

- k. Nothing contained in this chapter shall be construed to require any existing overhead facilities to be placed underground or to prohibit the upgrading, reconstruction or reconductoring of any existing overhead facilities with overhead construction;
- l. Nothing contained in this chapter shall be construed to alter the intent of any utility franchise agreement ordinance in effect on the effective date of the ordinance codified in this chapter.

#### 10.36.080 - Streetlights

##### A. Streetlights.

###### 1. General

- a. Street lighting shall be provided by the developer and shall be coordinated with Bastrop Power & Light, or Bluebonnet Electric Coop or their representative. Luminaires shall be light-emitting diode (LED), and shall be shielded to conform to the City's Outdoor Lighting Standards (Code of ordinance, Chapter 14, Appendix A, Sections 45.6-45.11) and be designed to minimize glare, light trespass, and sky glow. Correlated color temperature (CCT) shall not exceed 3,000 K. Lighting levels shall be in accordance with the following standards:

###### (1) Local Residential Streets.

For local residential streets with a posted speed of 25 miles per hour (mph) or less, lights are required only at intersections (vehicle headlights should be sufficient otherwise.) For local residential streets with posted speeds greater than 25 miles per hour, the goal is to provide a minimum maintained average pavement luminance of 0.5 candelas per square meter, which generally can be met with:

- (a) A light shall be installed at each intersection and shall be installed mid-block at a spacing of not more than two hundred feet.
- (b) Lights shall be installed at the end of a cul-de-sac and at midpoints if the length of the block exceeds two hundred feet.
- (c) As a minimum, lamps of not less than nine thousand five hundred (9,500) lumens (fifty-watt (50W) LED or equivalent) shall be installed on galvanized steel poles at a height of not less than twenty-five feet (25'). Power shall be provided by underground service or by overhead lines perpendicular to the street.

###### (2) Collector Streets and Local Nonresidential Streets. The goal is to provide a minimum maintained average pavement luminance of 0.6 candelas per square meter, which generally can be met with:

- (a) A light shall be installed at each intersection and shall not be installed midblock at a spacing of not more than one hundred eighty feet.
- (b) As a minimum, lamps of not less than twenty-seven thousand (27,000) lumens (ninety-watt (90W) LED or equivalent) shall be installed on galvanized steel poles at a height of not less than twenty-five feet. Collector streets adjoining residential areas may provide lamps of not less than nine thousand five hundred (9,500) lumens (fifty-watt (50W) LED or equivalent) upon approval of the City Engineer. Power shall be provided by underground service or by overhead lines perpendicular to the street.

###### (3) Arterials. The goal is to provide a minimum maintained average pavement luminance of 1.0 candelas per square meter, which generally can be met with:

- (a) A light shall be installed at each intersection and shall be installed midblock at a spacing of not more than one hundred sixty feet (160').

(b) As a minimum, lamps of not less than fifty thousand (50,000) lumens (one hundred fifty-watt (150W) LED or equivalent) shall be installed on galvanized steel poles at a height of not less than thirty-five feet (35'). Power shall be provided by underground service or by overhead lines perpendicular to the street.

(4) Private Streets.

(a) Streetlighting shall be installed at the same intensity and spacing as would be required for a public street of similar use.

(b) The responsibility for payment of maintenance and operation of a private streetlight system shall be the responsibility of the appropriate property-owners association.

DRAFT

**PROPOSED SUBDIVISION ORDINANCE REVISIONS  
CITY OF BASTROP**

**SUMMARY OF SIGNIFICANT FEATURES AND CHANGES  
March 2018**

[references in bracket are to Ordinance Section locations]

1. Ordinance has been reorganized in the following order:
  - General policies
  - Required dedications
  - Definitions
  - Roles of Planning and Zoning Commission and Staff
  - Procedures for Processing Plats
  - Form and Content of Plats
  - Design Standards
  - Impact Fees
2. References to Fees and Penalties refer back to Code of Ordinances
3. Revised to require adoption of Construction Standards Manual by City Council [10.04.005.C]
4. Requires plats to be consistent with Comprehensive Plan [10.04.020.A, 10.04.035.B]
5. New policies to prohibit extension of utilities to illegally subdivided lots [10.04.050.E], creating new lots in the floodplain [10.04.050.F], and issuing a building permit or certificate of occupancy to any building that encroaches over a platted lot line [10.04.050.G]
6. Provisions added on rough proportionality [10.04.040] to comply with State law
7. “Variances” changed to “Waivers and Exceptions” to simplify approval [10.04.040.E].
8. Clarification of triggers for platting (must increase the building footprint by more than 120 square feet [10.04.050.B]). Legal lots of record can be retained unless platting is triggered.
9. Provisions for park dedications have been revised to allow dedication of floodplain as park under certain circumstances, but limits the credit given to floodplain toward the parkland dedication requirement [10.08.020.F.1.b].
10. Definitions expanded [10.10]
  - a. “Channel sinuosity” defined
  - b. “Legal Lot of Record” defined
11. Roles of Planning & Zoning Commission and City Staff expanded [10.12]

- a. Delegation of authority of plat approval delegated to Planning and Zoning Commission [10.12.005.B]. Plats no longer need to be approved by City Council.
12. New Sketch Plat review process [10.16.015] where staff provides initial comments and classifies the plat by location, design approach and process. Applicant is encouraged to contact staff to determine requirements for a sketch plat and determine whether all requirements are applicable [10.16.015.B]
13. Flow charts added [Figures 10-1 thru 10-5], with revised deadlines and staff review times.
14. Staff is responsible for compiling addresses for notifications [10.16.020.A.3].
15. Requirement for submittal a tree inventory (trees greater than 10 inches in diameter, by species), tree mitigation plan and street tree plan [10.16.020.A.2.f-g, 10.16.020.B.2.e]
16. Revisions and clarification of expiration of incomplete applications [10.16.015.A.6], preliminary plats [10.16.020.A.7], and unfiled final plats [10.24.010.G]. Expiration of a preliminary plat extended to two years, and extension of remainder of preliminary plat after filing a final plat clarified.
17. Added provisions for residential replats [10.16.035.B] to comply with State law
18. Form and content of preliminary plats [10.20.010.B] and final plats [10.20.010.C] has been expanded
  - a. General requirements expanded and clarified
  - b. Requirements for some plat notes have been revised
  - c. Requirement to show 500-year flood boundary and minimum finished floor elevations (two feet above 100-year base flood elevation) in 500-year flood limit where applicable [10.20.010.C.2.v].
  - d. Requirement to show 100-year floodplain as an easement with a restrictive plat note [10.20.010.C.2.gg].
19. Procedures to appeal a decision by the Planning Director or Planning and Zoning Commission [10.24.010.D]
20. Requirement for drainage plans earlier in the subdivision design process [10.28.010.C] so that natural drainage can be incorporated wherever possible
21. More specifics on requirements for engineering plans [10.28.010]
22. Reference to City of Austin Standard Specifications Manual [10.28.010.I]
23. Added reference to erosion and sediment control requirement [10.28.010.K]
24. New and expanded requirements for Developer's Agreements and Financial Assurance [10.32.020]



25. Elimination of use of irrevocable letters of credit as a form of financial assurance [10.32.020.B.1].
26. Maintenance bond requirement changed to 100 percent for two years [10.32.020.B.3]
27. General construction sequence provided [10.32.020.I]
28. General Design Standards revised and expanded
  - a. Elimination of Suburban Subdivision and Small Rural Subdivision standards, leaving only Standard and Rural standards.
  - b. Two design approaches are identified:
    - i. City Design Approach intended for use inside the city limits
      1. Alleys required for rear access to any lots less than 60 feet wide [10.36.005.A.2]
      2. Block perimeters limited to 1600 feet to promote connectivity [10.36.005.A.3, 10.36.040.A.2], rather than block length
      3. Larger block must be broken by pedestrian Civic Space Lots [10.36.040.A.3]
    - ii. Rural Design Approach intended for use within the ETJ (Statutory and Area A)
      1. Five-step design process to identify lot yield at 1 unit per acre, identify conservation areas to be preserved, allow clustering of house sites, then align streets and lot lines [10.36.005.B]
    - iii. Subdivisions with more than 20 lots must have two points of access [10.36.005.C.2.g, 10.36.030.A.8]
    - iv. Low Impact Development requirements encouraged [10.36.005.D]
    - v. Houston Toad Habitat requirements acknowledged [10.36.005.E]
    - vi. Wildfire Protection Strategies encouraged [10.36.005.F]
29. Tree Preservation Required
  - a. Applies primarily to new development in the City and ETJ [10.36.010.C]
  - b. Does not apply to an existing home with less than one acre, to dead or dying trees or trees affecting building foundations or safety, to trees in sight visibility triangles, or trees within building footprint or utility line construction, or in rights-of-way or easements [10.36.010.D].
  - c. Mesquite, Bois d’Arc, Ashe Juniper, Locust, Hackberry, Gum Bumelia, Box Elder and Cottonwood are designated as secondary trees and have lesser protections [10.36.010.E]
  - d. Permit required to remove any tree over 10 inches in diameter. No permit required to remove anything smaller [10.36.010.F]
  - e. Based on tree inventory and preservation plan, developers must preserve 50 to 70 percent of Protected trees (greater than 18 inches), 5 to 20 percent of quality trees (10 to 18-inches in diameter) and 5 to 20 percent of large secondary trees (greater than 18 inches in diameter) depending on the size of the development. [Table 10-1]

- f. Trees over 10 inches that are removed must be mitigated by planting 25 to 100 percent of the caliper inches removed, based on development size and tree type [Table 10-2]
- g. Provisions are provided for planting offsite [10.36.010.I.6], for payment of money in lieu of planting [10.36.010.I.8], alternative tree plans and credit toward landscaping requirements [10.36.010.I.9].

30. Provisions for easements have been expanded and clarified [10.36.020]

- a. The width of the required BP&L easement in the front yard has been reduced from 20 feet in width to 10 feet [10.36.020.C.4]. There is already plenty of room to maneuver in the street right-of-way.
- b. Revised provisions for Public Open Space Easement for sight visibility triangles at intersection, now based on actual visibility rather than simply a corner clip [10.36.020.D]
- c. Additional requirements and clarification on drainage easements, including requiring that the 100-year floodplain be dedicated as an easement [10.36.020.E.9] and that there be a 50-foot setback easement from major creeks [10.36.020.E.11].
- d. Clarification on requirements for emergency access easements (fire lanes)[10.36.020.F.1] and requirement for cross-access easements on commercial lots [10.36.020.F.2].

31. Provisions for streets have been expanded, including combining requirement for city and urban streets, with separate provisions for rural streets called out.

- a. Requirements to minimize driveway access onto arterials and collectors for traffic safety and congestion minimization [10.36.030.A.9]
- b. Threshold for Traffic Impact Analysis (TIA) reduced to 100 trips/hour or 1,000 trips/day [10.36.030.C.1]
- c. Design requirements combined into a single table [Table 10-3]. Design speeds and pavement widths mostly are reduced.
- d. Pavement design has been increased to require five inches of concrete over six inches of lime-stabilized base or six inches of asphalt over six inches of stabilized subgrade [10.36.030.G.2].
- e. Provisions have been provided for a concrete ribbon curb where grass-lined swales are used [10.36.030.H.1]
- f. Provisions for wheel-chair ramps [10.36.030.H.5].
- g. Provisions for roundabouts in limited situations [10.36.030.I.1.d] including design guidance.
- h. Clarification on requirements for separation of street jogs [10.36.030.I.4].
- i. Provisions and limitations on dead-end streets [10.36.030.J.1], temporary turn-arounds, and cul-de-sacs, including a maximum length of a cul-de-sac of 200 feet [10.36.030.J.3].
- j. New provisions to allow private streets and gated communities on a case-by-case basis [10.36.030.J.6], including a requirement to build to City standards [10.36.030.J.6.d(1)], a requirement to create a public improvement district with a maintenance reserve fund [10.36.030.J.6.h], design requirements for entryways and access controllers [10.36.030.e(5) and 10.36.030.j] and processes to consider requests to convert private streets to public streets [10.36.030.i].
- k. New requirements for alleys [10.36.030.L].
- l. Expanded requirements on driveways [10.36.030.M]

- m. New provisions for street trees [10.36.030.S] which generally requires one tree in every front yard in new subdivisions and one tree every 100 feet in non-residential districts
32. New provisions on lots
- a. Prohibition of flag lots [10.36.040.B.5]
  - b. Require than no more than 50% of lots adjoining a major creek have their rear yard facing the creek [10.36.040.B.12] and no more than 50% of lots adjoining a public park be oriented to back to the park [10.36.040.B.13].
33. Expanded requirements for drainage [10.36.060]
- a. Requirement to design for four storms (first 1.5 inches, 2-year-24-hour storm, 25-year-24-hour storm and 100-year-24-hour storm [10.36.060.B.1
  - b. Expanded requirements for design, including requirement to provide an operations and maintenance plan [10.36.060.B.2]
  - c. Expanded design criteria, including limitations on use of the rational method [Table 10-8], recommended runoff coefficients [Table 10-12] and runoff curve numbers [Table 10-14].
  - d. Higher rainfall values based on more recent data [Table 10-9, Table 10.10, 10.36.060.B.6.e]
  - e. Requirement to perform downstream assessments [10.36.060.B.7.b] and options to address the water quality volume [10.36.060.B.7.a], streambank protection [10.36.060.b.7.e] and flood mitigation [10.36.060.B.7.f].
  - f. Expanded design criteria for streets [10.36.060.B.8.b], storm sewers [10.36.060.B.8.c], bridges and culverts [10.36.060.B.8.d], drainage channels [10.36.060.B.8.e], and detention structures [10.36.060.B.8.f]
34. Reorganized and simplified requirements for utilities, including water [10.36.070.B], wastewater [10.36.070.C], and electric-telephone and cable TV [10.36.070.D].
35. New standards for street lighting [10.36.080]

# Draft Subdivision Ordinance

Public Meeting

June 13, 2018



# What is the Subdivision Ordinance?

- The Subdivision Ordinance regulates the division of land, the layout of lots, blocks and streets, the provision of adequate infrastructure (including drainage), and protection from natural hazards
- Provides better land records as opposed to individual deeds
- The Subdivision Ordinance does not regulate land uses or building heights – that is in Zoning Ordinance
- The Subdivision does not regulate building construction, only public infrastructure construction



# Why Update Ordinance?

- Current Ordinance dates back to 1999, with amendments in 2000, 2004, and 2008
- Ordinance is disjointed, duplicative and weak in policy and design standards
- Subdivision is a ministerial process:
  - You cannot deny a plat unless it does not meet one of our standards
  - You cannot require design or infrastructure unless included in the Ordinance



# Organization of Ordinance

- General policies
- Required dedications
- Definitions
- Roles of P&Z and Staff
- Procedures for Processing Plats
- Form and Content of Plats
- Design Standards
- Impact Fees



# Significant Changes-Platting

- Strengthens requirement to plat
  - It's in City's interest to have everything properly platted
  - Platting is when we can require adequate rights-of-way, easements and infrastructure for orderly development
  - General requirement to plat as a condition of building and will continue to prohibit lot divisions and alterations without benefit of a plat
- We will continue to recognize "Pre-1981 lots of record", i.e., those existed prior to the City's adoption of subdivision regulations in April 1981.
- We have established exemptions from platting:
  - 400 SF or 20% or less of new building footprint over 5 years
  - Fences, signs, or flatwork





# Effect of Pre-1981 Lot of Record designation

- Anyone who has a lot, whether a pre-1981 lot of record or not, and who does not plan to build is not affected by the Ordinance.
- Anyone who has a platted lot and does not plan to change the boundaries of the lot, is not affected by the Ordinance.
- Anyone who has a pre-1981 lot of record (i.e. an unplatted lot that has not been altered since April 1981) and who does not plan to build more than 400 SF or 20% is not affected by the Ordinance.
- Anyone who has a platted lot and wishes to subdivide or change the boundaries must plat.
- Anyone who has a pre-1981 lot of record (i.e. an unplatted lot that has not been altered since April 1981) and wishes to build more than 400 SF in a five-year period must plat.
- Anyone who does not have a pre-1981 lot of record (i.e. a platted or unplatted lot that has been altered since April 1981 without getting a plat approved by the City) must plat their property.



# Significant Changes-Parkland Dedication

- Continue to require dedication of 1 acre for every 100 dwelling unit lots created, or fee in lieu
- Allows dedication of floodplain as parkland
  - Half credit for floodway fringe
  - No credit for floodway
- 50 percent Credit allowed for private parks (e.g. in gated communities)
- Requires dedication of parkland in Statutory ETJ
  - Recommending that HOA owns and maintains until City annexes



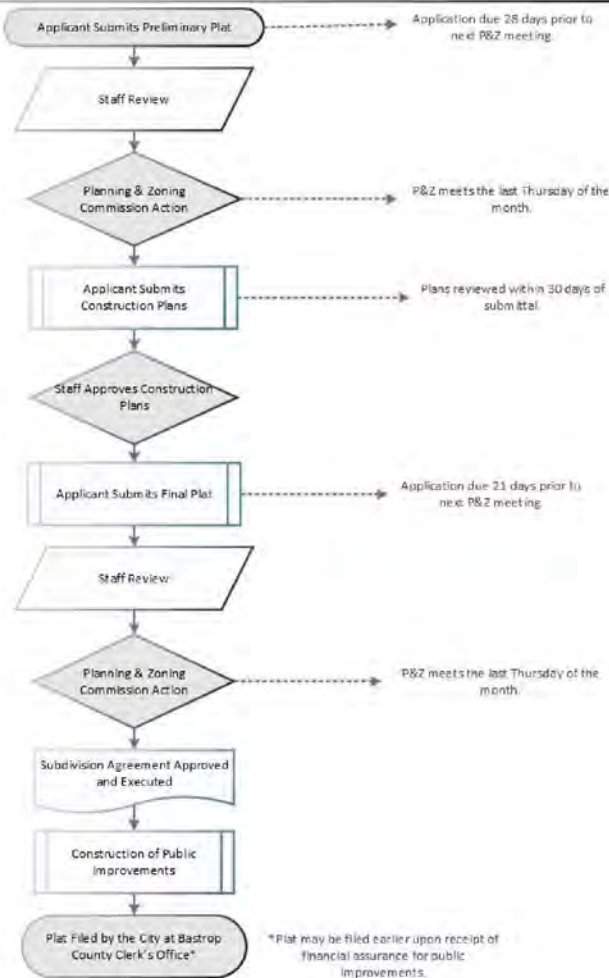

# Significant Changes-Process

- Requires initial Sketch Plat review
- Staff assumes responsibility for addresses and notification
- Delegates plat approval authority to P&Z
  - No longer will go to City Council for two readings
- Greater Use of Developer's Agreements
  - Outlines obligations of developer
- Clarification of plat expirations



# Significant Changes-Form and Content

- Requirements for submittals greatly expanded and clarified
- Additional requirements for easements and plat notes
- Revised number of submittals
- Requirement to submit drainage plans earlier in process
- More specifics on engineering plans
  - Reference to City of Austin Standard Specifications for materials and methods, not design
- Expanded requirement for Developer's Agreements and Financial Assurance
  - Eliminates use of letters of credit as a form of financial assurance
  - Maintenance bonds changed to 100% for two years



# Significant Changes-Design Standards

- Eliminates Suburban and Small Rural standards, leaving only Standard and Rural design standards
- Requires incorporation of two or more out of 20 Low Impact Development practices
- Adds reference to Houston toad habitat development requirements
- Add provisions for wildfire protection
  - Applies to Primary and Secondary Community Protection Zones defined by Texas A&M Forest Service
  - Requires 30-foot fire safety zone around structures



# Significant Changes-City Design Approach

- Intended for use in city limits with water and sewer service
- Design for pedestrians instead of just cars
- Requires alleys for rear entry for lots less than 60 feet in width to prevent garage-dominated frontages
- Requires block perimeters less than 1,600 feet to promote connectivity
  - Provision for civic open space lots for longer block lengths
- Commercial shopping centers can meet block perimeter using private drive aisles
- Industrial blocks cannot exceed 2,640 feet in length



# Significant Changes- Rural Design Approach



- Intended for use in ETJ without water and sewer service
- Promotes preservation of open space through clustering
- Use five-step process:
  - Predevelopment conditions and lot yield plan (1 d.u./acre)
  - Identify primary and secondary conservation areas
  - Identify potential development areas and house sites equal to yield plan
  - Align streets
  - Define lot lines (2 d.u./acre if on septic tank). Preserve remainder through conservation or agricultural easements

# Significant Changes-Tree Preservation



- Requires preservation and/or mitigation of certain trees over 10-inches in diameter at breast height (dbh)
- Requires tree survey (10-inch dbh or greater) prior to development (plat or site plan)
- Does not apply to:
  - Developments already in review or construction
  - Property less than one acre with a single family house
  - Trees that are determined to be diseased, dead, dying, creating a nuisance or damaging a foundation
  - Trees in right-of-way, easements, drainage facilities, utility routes, capital improvement projects, or in visibility triangles
  - Tree and brush clearing less than 10-inches in diameter





## Significant Changes-Tree Preservation cont.

- Secondary trees include Mesquite, Bois d'Arc, Ashe Juniper, Locust, Hackberry, Gum Bumelia, Box Elder, and Cottonwood over 10-inches in diameter
- Large Secondary trees are those greater than 18-inches dbh
- Quality trees are any tree other than secondary tree greater than 10-inches dbh
- Protected trees are quality trees greater than 18-inches dbh
- Preservation and mitigation standards are dependent on tree type and subdivision size



# Significant Changes-Easements

- Reduces size of BP&L easements adjacent to street ROW from 20 feet to 10 feet
- Revises Public Open Space Easements (visibility triangles) at street intersections
- Requires dedication of 100-year floodplain as an easement, with a note on development restrictions
- Requires 50-foot streambank buffer easements along certain streams
- Requires cross-access easements in commercial areas

1.  $L$  AND  $R$  ARE THE RESULTING SIGHT DISTANCES TO THE LEFT AND RIGHT WHEN:  
 1.  $L_1$  AND  $R_1$  AND  $R_2$  RIGHT LINE MEASUREMENT FROM THE CURB LINE, OR  
 2.  $L_2$  OR  $R_2$  RIGHT LINE MEASUREMENT FROM THE PROPERTY LINE, ARE CLEAR OF OBSTRUCTIONS.

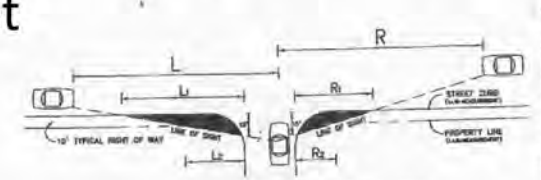
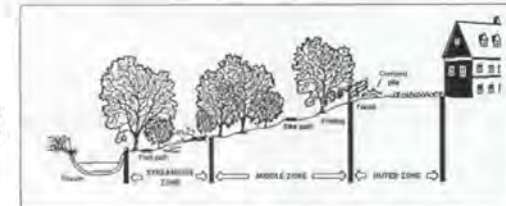

FIGURE C  
STREETWAY SIGHT DISTANCE REQUIREMENTS

ROADWAY TYPE	L	L <sub>1</sub>	L <sub>2</sub>	R	R <sub>1</sub>	R <sub>2</sub>
ARTERIAL	300'	400'	120'	300'	120'	40'
COLLECTOR	300'	240'	120'	300'	140'	30'
LOCAL	300'	115'	75'	300'	170'	40'



Characteristic	Streamside Zone	Middle Zone	Outer Zone
Width	Proportion to local plan indicates recommended bufferwidth.	50 - 100 feet depending on stream order, slope, and 100-year floodplain.	25-foot minimum setback from structures.
Vegetative Target	Unmodified mature forest, wetlands if necessary.	Managed forest, some clearing allowed.	Forest/scruboak, but usually buffers.
Allowable Uses	<b>Very Restricted</b> e.g., road, utility, utility right-of-way, floodwall	<b>Restricted</b> e.g., some recreational uses, some streambank BMP, dike paths, tree removal by permit	<b>Unrestricted</b> e.g., residential use including lawn, golfing, recreation, pool, water, wind (nearshore BMP)

These stream zones describe the location of an affecting water feature buffer zone. The actual location, management and regulation must only be done.

# Significant Changes-Streets

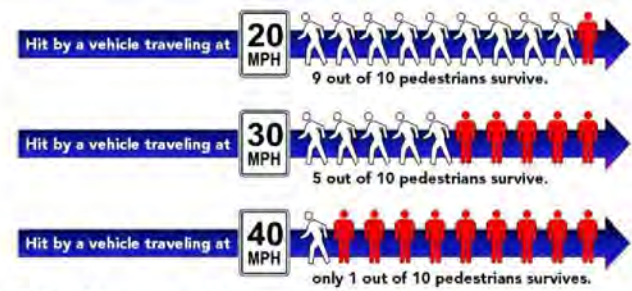

- Reduces threshold for traffic impact analysis to 100/trips/hour or 1,000 trips/day
- Combines most street design requirements into a single table, with slower design speeds and narrower pavement widths
- Pavement design increased to 5-inches of concrete or 6-inches of asphalt over 6-inches of stabilized subgrade
- Ribbon curbs are allowed where grass-lined swales are used
- Wheelchair ramps provided
- Roundabouts allowed on case-by-case basis in limited circumstances

# Significant Changes- Streets cont.



- Limitations on dead-end streets and cul-de-sacs. Cul-de-sacs limited to 200-feet in length and serving no more than 20 lots.
- Private streets and gated communities to be allowed on a case-by-case basis in SF, MF and PD districts.
  - Requires approval of gate and private amenity plan
  - Requires that streets meet city design standards
  - Requires mandatory HOA with street maintenance reserve fund
  - Includes provisions for conversion of private to public streets
- Design standards for alleys

# Significant Changes-Streets cont.

- Expanded requirements on driveways:
  - Number and spacing of driveways allowed
  - Location and proximity to intersections
  - Allows alternative paving (concrete, asphalt, or city-approved all-weather and dust free surfaces, pavers, two-track drives)
- Street Naming and Sign Requirements
- Sidewalks required
  - 5-foot sidewalks on both sides of street, including in Statutory ETJ
  - May defer installation to homebuilder, with 4-year 20% bond



## Significant Changes-Streets cont.



- Parking lots allowed to have alternative paving (city-approved all-weather and dust free surfaces) on case-by-case basis
- Adds provisions for street trees
  - SF: one tree per lot
  - MF, Non residential: 1 tree/100 feet
  - Location, separation from utilities, intersections, fire hydrants, street lights, allows root barrier system
  - 13 species allowed, diversity between blocks
  - Maintenance by adjacent property owner

# Significant Changes-Lots and Blocks

- Each lot must front a public street or approved public access easement or private street
- Flag lots are prohibited
- Lot width to be measured at building line
  - Minimum 33 feet wide at chord on cul-de-sac
- Creeks and Streams: No more than 50% of lots can back up to Colorado River, Piney Creek, Gills Branch or other perennial stream or FEMA floodplain)
- Public Parks: No more than 50% of lots can back up to a public park. Others must face public park across a public street.

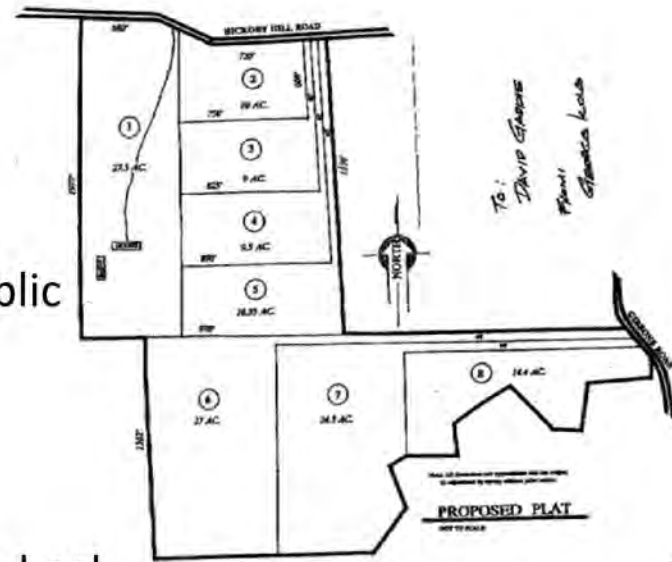

# Significant Changes-Drainage

- Extend 2-foot freeboard above 100-year base flood elevation requirement into 500-year floodplain
- Required design for 4 storm events:
  - Water quality (1<sup>st</sup> 1.5 inches)
  - Streambank protection (2-year, 24-hour storm)
  - Conveyance (25-year, 24-hour storm)
  - Flood (100-year, 24-hour storm)
- Requirement to look at drainage earlier in process, so problems and unnecessary infrastructure can be avoided where possible
- Adoption of iSWM Technical Manual for design

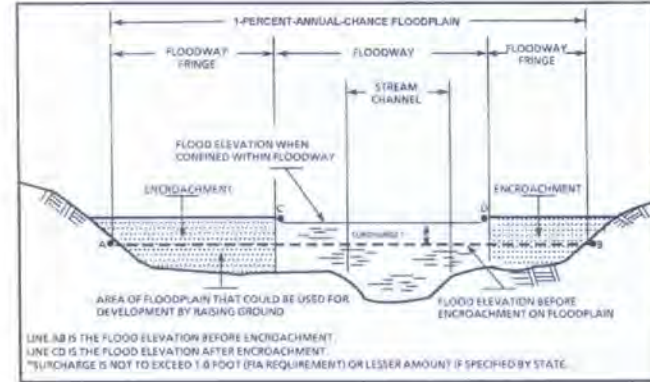



# Significant Changes-Drainage cont.

- Expansion and limitations of hydrologic methods
  - Rational method limited to 100 acres or less
- New updated IDF coefficients and rainfall data
- Guidance on use of runoff coefficients
- Must show use of one water quality treatment method:
  - Bioretention
  - Enhanced swales
  - Detention
  - Sand filters
  - infiltration
  - ponds
  - green roofs
  - wetlands



# Significant Changes-Drainage cont.

- Downstream Assessments required
  - Shows impact of development on volume and velocities downstream
  - May eliminate the requirement for detention
- Options for streambank protection (must obtain 404 permit from Corps of Engineers)
- Options for flood mitigation
- Design standards for street drainage, storm sewers, bridges and culverts, drainage channels, and detention/retention ponds.
  - Multi-stage outlet structures



# Significant Changes-Utilities

- Underground utilities
- Water lines
  - Fire flows
  - Fire hydrant spacing
- Wastewater systems
  - Sewer lines and manholes
  - Onsite sanitary sewer facilities
- Electric, Telephone and Cable TV Utilities
  - Underground, with exceptions
- Street lighting
  - Updated for LED lights, including color



# Next Steps

- Met with County staff on April 4<sup>th</sup>
  - Main concerns regarded parks and infrastructure requirements in the ETJ
- Meetings this week with:
  - Utility Companies-e.g. Aqua, Bluebonnet
  - General public
  - Developers, home builders
  - Board of Realtors luncheon
  - Engineers, Surveyors
- Public hearing and recommendation by P&Z – July 26<sup>th</sup>
- City Council – August



# Questions and Comments

